

## Unique selling propositions

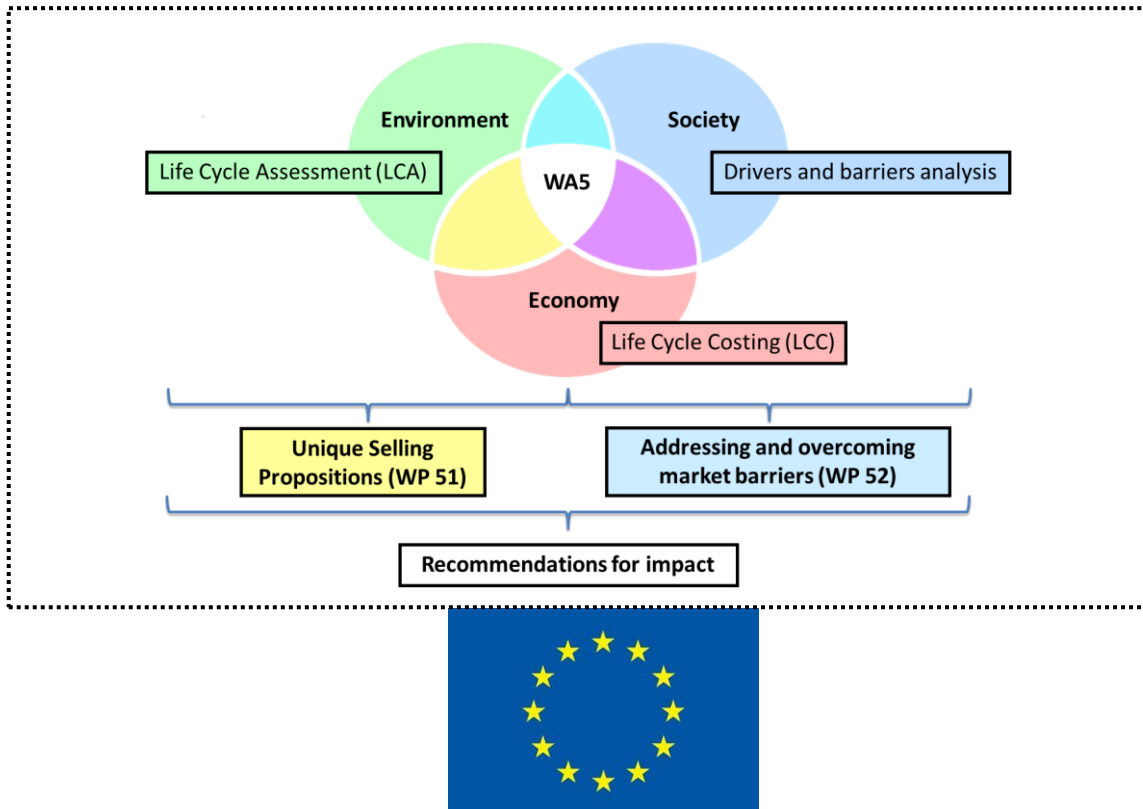

The research leading to these results has received funding from the European Union Seventh Framework Programme (FP7/2007-2013) under Grant Agreement no. 308339 for the research project DEMEAU

**Title: Unique selling propositions**

**Summary:** Within Work Area 5 of the DEMEAU project, selected innovative technologies and tools for emerging contaminants removal and monitoring are assessed in their environmental and economic benefits and impacts by using life-cycle based tools such as environmental Life Cycle Assessment (LCA) and economic Life Cycle Costing (LCC). Six case studies were assessed to quantify their environmental and economic profiles and formulate unique selling propositions to promote market uptake and implementation. These case studies include managed aquifer recharge for groundwater replenishment or for drinking water production in combination with advanced oxidation process, hybrid ceramic membrane filtration with powdered activated carbon for tertiary wastewater treatment, automatic neural net control systems to optimize membrane operation, ozonation of wastewater treatment plant effluent, and bioassays as screening tool for water quality monitoring. This report summarizes the study layout, input data, and results of LCA and LCC for all case studies and indicates unique selling propositions based on the outcomes of the assessment.

<b>Grant agreement no:</b>	308339
<b>Work Package:</b>	WP51
<b>Deliverable number:</b>	D51.1
<b>Partner responsible:</b>	FHNW
<b>Deliverable author(s):</b>	Thomas Gross (FHNW), Christoph Hugi (FHNW), Anna Kounina (Quantis), Christopher Oberschelp (FHNW), Christian Remy (KWB), Kristina Wencki (IWW)
<b>Quality assurance:</b>	Harrie Besselink (BDS), Aurélie Gallice (Veolia), Jörg Gebhardt (Aquatune), Marta Hernandez (Cetaqua), Nathalie Hubaux (Neugut), Hein de Jonge (Dunea), Christa McArdell (Eawag), Thomas Wintgens (FHNW)
<b>Planned delivery date:</b>	August 31, 2015
<b>Actual delivery date:</b>	30 October 2015
<b>Dissemination level:</b>	Public

© 2012 DEMEAU

This Demonstration project 'Demonstration of promising technologies to address emerging pollutants in water and wastewater' (DEMEAU) has received funding from the European Union's Seventh Programme for Research, Technological Development and Demonstration under Grant Agreement no. 308330. All rights reserved. No part of this book may be reproduced, stored in a database or retrieval system, or published, in any form or in any way, electronically, mechanically, by print, photograph, microfilm or any other means without prior written permission from the publisher.

This publication reflects only the author's views and the European Union is not liable for any use that may be made of the information contained therein.

## Table of contents

LIST OF FIGURES .....	V
LIST OF TABLES.....	IX
LIST OF ABBREVIATIONS AND UNITS .....	XI
<b>1 INTRODUCTION.....</b>	<b>1</b>
<i>1.1 Overview and approach.....</i>	<i>1</i>
<i>1.2 Investigated technologies.....</i>	<i>1</i>
1.2.1 Managed Aquifer Recharge (MAR) .....	1
1.2.2 Hybrid Ceramic Membrane Filtration (HCMF) and Automatic Neural Net Control Systems (ANCS) .....	2
1.2.3 Advanced Oxidation Processes .....	2
1.2.4 In-vitro bioassays.....	2
<b>2 METHODS .....</b>	<b>3</b>
<i>2.1 Life Cycle Assessment (LCA).....</i>	<i>3</i>
2.1.1 USEtox™ model for emerging contaminants .....	3
<i>2.2 Life Cycle Costing (LCC).....</i>	<i>3</i>
<i>2.3 Selection of case studies.....</i>	<i>4</i>
<b>3 MANAGED AQUIFER RECHARGE (MAR) .....</b>	<b>5</b>
<i>3.1 Technology description and relevant application areas.....</i>	<i>5</i>
<i>3.2 Case studies conducted in DEMEAU.....</i>	<i>7</i>
<i>3.3 CS1.1: Pilot-scale AOP as MAR pre-treatment.....</i>	<i>7</i>
3.3.1 Case study description.....	7
3.3.2 LCA and LCC: Definition of goals and scope.....	9
3.3.2.1 Definition of goals .....	9
3.3.2.2 Functional unit.....	9
3.3.2.3 System boundaries and investigated systems .....	9
3.3.2.4 LCA and LCC inventory .....	11
3.3.3 Results and discussion.....	14
3.3.3.1 LCA impact assessment .....	14
3.3.3.2 LCC assessment.....	18
3.3.3.3 Summary of LCA/LCC results.....	22
3.3.4 Conclusions and Unique Selling Propositions.....	23
<i>3.4 CS1.2: Pilot-scale additional organic reactive layer.....</i>	<i>24</i>
3.4.1 Case study description.....	24
3.4.2 LCA and LCC: Definitions of goals and scope.....	25

3.4.2.1	Definition of goals .....	25
3.4.2.2	Functional unit .....	26
3.4.2.3	System boundaries and investigated systems .....	26
3.4.2.4	LCA and LCC inventory .....	28
3.4.3	Results and discussion.....	31
3.4.3.1	LCA impact assessment .....	31
3.4.3.2	LCC assessment.....	39
3.4.3.3	Summary of LCA/LCC results.....	42
3.4.4	Conclusions and Unique Selling Propositions .....	42
4	<b>HYBRID CERAMIC MEMBRANE FILTRATION (HCMF) AND AUTOMATIC NEURAL NET CONTROL SYSTEMS (ANCS) .....</b>	<b>44</b>
4.1	<i>Technology description and relevant application areas .....</i>	<i>44</i>
4.1.1	Hybrid ceramic membrane filtration .....	44
4.1.2	Automatic Neural Net Control System (ANCS).....	44
4.2	<i>Case studies conducted in DEMEAU.....</i>	<i>45</i>
4.3	<i>CS 2.1: Hybrid ceramic membrane filtration (HCMF) in wastewater treatment.....</i>	<i>45</i>
4.3.1	Case study description.....	45
4.3.1.1	Current wastewater treatment plant.....	45
4.3.1.2	Emerging contaminant removal system.....	45
4.3.2	LCA and LCC: Definition of goals and scope.....	46
4.3.2.1	Definition of goals.....	46
4.3.2.2	Functional unit .....	47
4.3.2.3	System boundaries and investigated systems .....	47
4.3.2.4	LCA and LCC inventory .....	47
4.3.2.5	Assumptions.....	49
4.3.3	Results and discussion.....	50
4.3.3.1	LCA impact assessment .....	50
4.3.3.2	LCC assessment.....	57
4.3.4	Conclusions and Unique Selling Propositions .....	61
4.4	<i>CS 2.2: ANCS in drinking water treatment.....</i>	<i>64</i>
4.4.1	Case study description.....	64
4.4.1.1	Existing system at full-scale.....	64
4.4.2	LCA and LCC: Definition of goals and scope.....	66
4.4.2.1	Definition of goals .....	66
4.4.2.2	System boundaries and investigated systems .....	67
4.4.2.3	Functional unit .....	69

4.4.2.4	Life Cycle Inventory for LCA.....	69
4.4.2.5	Life Cycle Inventory for LCC.....	71
4.4.3	Results and discussion.....	73
4.4.3.1	LCA impact assessment.....	73
4.4.3.2	LCC assessment.....	75
4.4.3.3	Summary of LCA/LCC results.....	79
4.4.4	Conclusions and Unique Selling Propositions.....	80
5	ADVANCED OXIDATION PROCESSES (AOPs).....	81
5.1	<i>Technology description and relevant application areas.....</i>	<i>81</i>
5.2	<i>Case studies conducted in DEMEAU.....</i>	<i>82</i>
5.3	<i>CS3.1: Ozonation of WWTP effluent.....</i>	<i>82</i>
5.3.1	Case study description.....	82
5.3.1.1	Current system.....	82
5.3.1.2	Emerging contaminant removal system.....	83
5.3.2	LCA and LCC: Definition of goals and scope.....	84
5.3.2.1	Definition of goals.....	84
5.3.2.2	System boundaries and investigated systems.....	84
5.3.2.3	Functional unit.....	85
5.3.2.4	LCA and LCC inventory.....	85
5.3.2.5	Assumptions.....	88
5.3.2.6	Key limitation.....	88
5.3.3	Results and discussion.....	89
5.3.3.1	LCA impact assessment.....	89
5.3.3.2	LCC assessment.....	98
5.3.4	Conclusions and Unique Selling Propositions.....	101
6	BIOASSAYS.....	103
6.1	<i>Technology description and relevant application areas.....</i>	<i>103</i>
6.2	<i>Case studies conducted in DEMEAU.....</i>	<i>103</i>
6.3	<i>CS4.1: In-vitro bioassays at Waternet (NL).....</i>	<i>104</i>
6.3.1	Case study description.....	104
6.3.2	Qualitative LCA of bioassays.....	105
6.3.3	Cost assessment of bioassays.....	105
6.3.4	Conclusions and Unique Selling Propositions.....	106
7	CONCLUSIONS AND SUMMARY OF UNIQUE SELLING PROPOSITIONS.....	108
7.1	<i>Managed aquifer recharge (MAR).....</i>	<i>108</i>
7.2	<i>Hybrid ceramic membrane filtration (HCMF) and Automatic Neural Net Control Systems (ANCS)....</i>	<i>109</i>

---

7.2.1	Hybrid ceramic membrane filtration (HCMF) .....	109
7.2.2	Automatic Neural Net Control Systems (ANCS).....	109
7.3	<i>Advanced oxidation processes (AOPs)</i> .....	110
7.4	<i>In-vitro bioassays</i> .....	110
7.5	<i>Conclusions</i> .....	111
8	REFERENCES .....	112
ANNEX-A: BACKGROUND DATA FOR CASE STUDY CS1.1 .....		116
ANNEX-B: BACKGROUND DATA FOR CASE STUDY CS1.2 .....		118
ANNEX-C: BACKGROUND DATA FOR CASE STUDY CS2.1 .....		120
ANNEX-D: BACKGROUND DATA FOR CASE STUDY CS3.1.....		133

## List of Figures

Figure 3-1: Most common MAR techniques (Gale and Dillon 2005) ASR: Aquifer Storage and Recovery; ASTR: Aquifer Storage Transfer and Recovery.....	6
Figure 3-2: Flow chart of existing drinking water treatment scheme at Dunea (© WHO 2009) .....	8
Figure 3-3: System boundaries of LCA/LCC study for drinking water treatment at Scheveningen (Dunea).....	10
Figure 3-4: Scenarios for LCA and LCC of existing drinking water treatment (S1) and two alternatives with AOP pre-treatment (S2, S3) at Scheveningen .....	10
Figure 3-5: Environmental profiles of three scenarios (1: MAR + post-treatment, 2: O <sub>3</sub> /H <sub>2</sub> O <sub>2</sub> + MAR + post-treatment, 3: O <sub>3</sub> /H <sub>2</sub> O <sub>2</sub> /UV + MAR + post-treatment) related to scenario S1 (= 100%) for each respective indicator.....	14
Figure 3-6: Cumulative energy demand (fossil) of drinking water treatment scenarios in Scheveningen.....	15
Figure 3-7: Global warming potential (100 years) of drinking water treatment scenarios in Scheveningen.....	16
Figure 3-8: Human toxicity potential (non-carcinogenic) of drinking water treatment scenarios in Scheveningen.....	17
Figure 3-9: Changes in human toxicity (non-cancer) due to drinking water consumption based on 8 heavy metals and 8 emerging contaminants (left) and 8 emerging contaminants only (right) for all three scenarios (note the different scales on x-axis; abbreviations as in Table 3-3).....	17
Figure 3-10: Water scarcity footprint of drinking water treatment scenarios in Scheveningen.....	18
Figure 3-11: CAPEX per system capacity of drinking water treatment scenarios in Scheveningen .....	19
Figure 3-12: OPEX per m <sup>3</sup> water intake of drinking water treatment scenarios at Scheveningen.....	20
Figure 3-13: Net present value (NPV) of drinking water treatment scenarios at Scheveningen over time.....	20
Figure 3-14: NPV per m <sup>3</sup> water intake of drinking water treatment scenarios at Scheveningen under varying system lifetimes.....	21
Figure 3-15: Aerial picture of groundwater recharge system at Sant Vicenç dels Horts.....	24
Figure 3-16: Proposed design for the reactive layer at MAR system at SVH.....	25
Figure 3-17: System boundaries of LCA/LCC study for MAR systems at SVH.....	26
Figure 3-18: Scenarios for LCA and LCC of different MAR systems and reference at SVH.....	28
Figure 3-19: Environmental profiles of six scenarios for groundwater recharge at SVH.....	32
Figure 3-20: Cumulative energy demand (fossil) of groundwater recharge scenarios in SVH.....	33
Figure 3-21: Global warming potential (100 years) of groundwater recharge scenarios in SVH.....	34
Figure 3-22: Freshwater eutrophication (P) of groundwater recharge scenarios in SVH.....	34
Figure 3-23: Marine eutrophication (N) of groundwater recharge scenarios in SVH.....	35
Figure 3-24: Ecotoxicity (freshwater) of groundwater recharge scenarios in SVH.....	35
Figure 3-25: Human toxicity (non-cancer) for groundwater recharge scenarios in SVH.....	36

Figure 3-26: Water scarcity footprint of groundwater recharge scenarios in SVH (note that 0.01 m<sup>3</sup>-eq relate to 1% water loss in the systems compared to the produced volume).....37

Figure 3-27: Sensitivity of global warming potential with min-max infiltration rates.....38

Figure 3-28: Sensitivity of ecotoxicity using tertiary WWTP effluent as feed water for infiltration .....38

Figure 3-29: CAPEX per system capacity for groundwater recharge scenarios in SVH.....39

Figure 3-30: OPEX per m<sup>3</sup> infiltrated water for groundwater recharge scenarios in SVH.....40

Figure 3-31: Net present value (NPV) of groundwater recharge scenarios in SVH over time .....41

Figure 3-32: Net present value per m<sup>3</sup> infiltrated water of groundwater recharge scenarios in SVH.....41

Figure 3-33: Net present value per m<sup>3</sup> infiltrated water of groundwater recharge scenarios in SVH under varying infiltration rates.....42

Figure 4-1: Process flowchart for the complete wastewater treatment plant at Birsfelden. It includes the three steps mechanical, bio-chemical and sludge treatment from the current plant and the extension scenario by a emerging contaminant removal stage (dashed box).....46

Figure 4-2: System boundaries of the LCA for the WWTP with hybrid membrane systems .....47

Figure 4-3: Left panel: Ceramic membrane rack inside a membrane basin consisting of 16 membrane modules and a stainless steel frame (Sawatzki 2014); right panel: change of a ZeeWeed 500D polymeric membrane rack consisting of PVDF membranes and a stainless steel frame (GE 2013).....50

Figure 4-4: Overall relative LCA impact assessment of the BAU, HCMF and HPMF scenarios for the different indicators.....51

Figure 4-5: Freshwater ecotoxicity (A); human toxicity, cancer effect (B); and human toxicity, non-cancer effect (C) of WWTP Birs effluents: BAU, BAU+HCMF and BAU+HPMF scenarios (note: CTU values are not directly comparable with the other endpoint impact categories).....52

Figure 4-6: Extrapolation of the emerging contaminant entire load contribution to eco- and human toxicity effect of the current Birsfelden and the 2 membrane scenarios (note different y-axis in 3<sup>rd</sup> quartile).....54

Figure 4-7: Climate change impacts of BAU WWTP, BAU WWTP with HCMF and BAU WWTP with HPMF scenarios with a global level of detail (panel a); and detail of current operation and membrane operation (panel b) .....56

Figure 4-8: Cumulative energy demand fossil (A) and nuclear (B) .....57

Figure 4-9: Specific investment costs per m<sup>3</sup> treatment capacity/yr. for full-scale extension of the current WWTP by emerging pollutant removal with hybrid ceramic and polymeric membrane filtration systems.....58

Figure 4-10: Operational costs per m<sup>3</sup> for a full-scale extension of the current treatment plant at Birsfelden by emerging contaminant removal with ceramic and polymeric membrane filtration systems.....59

Figure 4-11: Net present value of an extension of the current treatment plant at Birsfelden by emerging contaminant removal with ceramic and polymeric membrane filtration over a time period of 30 years.....60

Figure 4-12: Net present value per m<sup>3</sup> treated water for extension of the current treatment plant at Birsfelden by emerging contaminant removal with ceramic and polymeric



membrane filtration over a time period 30 years with and without a subsidy of 75% of initial investment costs.....	60
Figure 4-13: Net present value development of a full-scale extension of the current treatment plant at Birsfelden by emerging contaminant removal with ceramic and polymeric membrane filtration systems over a time period 30 years with varying membrane lifetimes (HCMF: 9 / 12 / 15 years; HPMF: 2 / 7 / 12 years).....	61
Figure 4-14: Principle diagram of drinking water treatment (left panel) and backwash water treatment process design (right panel), both at WAG Roetgen .....	65
Figure 4-15: Training and working scheme of ANCS .....	65
Figure 4-16: UF pilot with two independent treatment lines.....	66
Figure 4-17: System boundaries of LCA/LCC study for ANCS at WAG Roetgen .....	67
Figure 4-18: Scenarios for LCA and LCC for implementation of ANCS at backwash water treatment in WAG Roetgen.....	68
Figure 4-19: Life cycle inventory of backwash water treatment at WAG Roetgen (data from: status quo 2014) .....	69
Figure 4-20: Environmental profiles of scenarios (1: status quo (2014), 2: ANCS (conservative), 3: ANCS (potential)) related to max scenario = 100 %.....	73
Figure 4-21: Cumulative energy demand (fossil) of scenarios for BW-UF plant at Roetgen .....	74
Figure 4-22: Global warming potential (100 years) of scenarios for BW-UF plant at Roetgen .....	75
Figure 4-23: CAPEX per system capacity of scenarios for BW-UF plant at Roetgen .....	76
Figure 4-24: OPEX per m <sup>3</sup> of incoming backwash water of scenarios for BW-UF plant at Roetgen .....	76
Figure 4-25: Net present value (NPV) per m <sup>3</sup> of incoming backwash water of scenarios for BW-UF plant at Roetgen over a course of 30 years .....	77
Figure 4-26: Change in net present value (NPV) (referring to <i>status quo</i> ) of ‘conservative’ ANCS scenarios in Roetgen with break-even-points BEP1 and BEP2.....	78
Figure 4-27: Change in net present value (NPV) (referring to <i>status quo</i> ) of ‘potential’ ANCS scenarios in Roetgen with break-even-points BEP1 and BEP2.....	78
Figure 5-1: Schematic drawing of an ozone reactor, translated from: Abegglen and Siegrist 2012.....	81
Figure 5-2: Flow chart of the new ozone reactor at the wastewater treatment plant Neugut (source: WWTP Neugut).....	83
Figure 5-3: Oxygen tank with evaporator, ozone generator .....	84
Figure 5-4: System flow charts for the BAU and O <sub>3</sub> scenarios.....	85
Figure 5-5: Overall wastewater treatment plant performance: freshwater and marine eutrophication results for no wastewater treatment, BAU and O <sub>3</sub> scenarios.....	89
Figure 5-6: Overall wastewater treatment plant performance: freshwater and marine eutrophication results for no wastewater treatment, BAU and O <sub>3</sub> scenarios Overall wastewater treatment plant performance.....	90
Figure 5-7: Overall wastewater treatment plant performance: freshwater and marine eutrophication results for no wastewater treatment, BAU and O <sub>3</sub> scenarios Impact on cumulative energy demand, fossil and nuclear of BAU and O <sub>3</sub> scenario .....	91
Figure 5-8: Impact on climate change of BAU and O <sub>3</sub> scenario .....	91

---

Figure 5-9: Impact on climate change of the BAU and O <sub>3</sub> scenarios compared to an O <sub>3</sub> scenario with the wastewater treatment plant located in Germany .....	92
Figure 5-10: Contribution to climate change of the ecoinvent v2.2 process Wastewater treatment plant, class 2/CH/I U .....	92
Figure 5-11: Contribution to human toxicity, cancer and non-cancer effect as well as ecotoxicity of BAU and O <sub>3</sub> scenarios for the 11 monitored DEMEAU substances .....	93
Figure 5-12: Contribution to human toxicity, cancer and non-cancer effect as well as ecotoxicity of BAU and O <sub>3</sub> scenarios.....	94
Figure 5-13: Characterization factors of monitored substances vs. substances covered in USEtox for human toxicity, cancer and non-cancer effect as well as ecotoxicity .....	95
Figure 5-14: Results of the extrapolation of the emerging contaminant entire load contribution to human toxicity, cancer and non-effect as well as ecotoxicity of BAU and O <sub>3</sub> scenarios.....	97
Figure 5-15: CAPEX for business-as-usual treatment and ozonation in Neugut .....	98
Figure 5-16: OPEX per m <sup>3</sup> treated water for business-as-usual treatment and ozonation in Neugut .....	99
Figure 5-17: NPV of business-as-usual treatment and ozonation in Neugut over time .....	100
Figure 5-18: NPV per m <sup>3</sup> treated wastewater for business-as-usual treatment and ozonation in Neugut under varying system lifetimes.....	100
Figure 6-1: Bioassay analysis .....	103
Figure D-1: Contribution to particulate matter and terrestrial acidification of BAU and O <sub>3</sub> scenarios.....	136

## List of Tables

Table 3-1: Operational data of the different scenarios for Scheveningen.....	11
Table 3-2: Investment and operational costs for the different scenarios for Scheveningen.....	12
Table 3-3: Water quality parameters of different scenarios in Scheveningen.....	13
Table 3-4: NPV per m <sup>3</sup> water intake of drinking water treatment scenarios at Scheveningen per m <sup>3</sup> water intake under varying system lifetimes.....	21
Table 3-5: Summary of LCA and LCC results for Dunea case study.....	23
Table 3-6: Operational data of the different systems analysed in LCA.....	29
Table 3-7: Water quality data of the different scenarios in SVH.....	30
Table 3-8: Summary of LCA and LCC results for SVH case study (S1: Pond infiltration, S2: Pond infiltration + sand washing, S3: Pond infiltration + organic layer, S4: riverbed scarification, S5: scarification in channel, S6: surface water treatment + well injection).....	43
Table 4-1: Summary of life cycle inventory of BAU WWTP operation (AIB 2012); COD, TN and TP emissions into water of BAU WWTP (Lüthy 2014); and emerging contaminants and their removal by PAC followed UF or sand filtration (available data from Swiss wastewater from Sterkele and Gujer 2009 and Margot et al. 2013) for PAC doses between 10 and 20 mg/L. Detailed life cycle inventory data are provided in Annex-C.....	48
Table 4-2: Impacts of production of 1 kg of PAC according to Bayer et al. 2005, adjusted by the PAC SAE Super producer Cabot Norit Nederland B.V. (Muller 2014, pers. comm.) and Thommen-Furler AG (Wysser 2014, pers. comm.).....	49
Table 4-3: Key parameters to estimate the entire emerging contaminant load toxicity.....	53
Table 4-4: Summary of LCA (net impact) and LCC results for Birsfelden case study.....	63
Table 4-5: Life cycle inventory for different scenarios without and with ANCS system.....	70
Table 4-6: Material demand for 210 UF membrane modules.....	71
Table 4-7: Materials used from ecoinvent v2.2 for modelling chemicals and electricity in operation phase.....	71
Table 4-8: Cost inventory for different scenarios of ANCS.....	72
Table 4-9: Summary of LCA and LCC results for WAG case study.....	79
Table 5-1: Life cycle inventory of the WWTP Neugut as in 2013, ozonation process as of 2014 (source: WWTP Neugut) and emerging contaminant concentration (source: Eawag).....	86
Table 5-2: Key modelling assumptions.....	88
Table 5-3: Key parameters to estimate the entire emerging contaminant load toxicity.....	96
Table 5-4: NPV per m <sup>3</sup> treated wastewater for business-as-usual treatment and ozonation in Neugut under inflation and discount rates.....	101
Table 5-5: Summary of LCC results for Neugut case study.....	102
Table 6-1: Monitoring schedule of Waternet for broad chemical screening of water quality.....	105
Table 6-2: Simplified cost assessment of traditional monitoring strategy and bioassay screening at Waternet (target effect: 32 substances causing endocrine disrupting effects).....	106
Table A-1: Infrastructure inventory data.....	116

---

Table A-2: LCA inventory data.....	117
Table B-1: LCA inventory data.....	118
Table B-2: Background datasets for LCA.....	118
Table B-3: LCC inventory data .....	119
Table C-1: LCA inventory data of the current WWTP Birs (per m <sup>3</sup> water treated).....	120
Table C-2: LCA inventory data of the current WWTP Birs extended by the hypothetical full-scale hybrid ceramic membrane system (per m <sup>3</sup> water treated) .....	123
Table C-3: LCC inventory data: capital expenditure (CAPEX).....	130
Table C-4: LCC inventory data: Operational expenditure (OPEX).....	131
Table D-1: LCA inventory data of the Neugut WWTP without ozonation.....	133
Table D-2: LCA inventory data of the Neugut WWTP extended by ozonation.....	134
Table D-3: LCC inventory data: capital expenditure (CAPEX).....	136
Table D-4: LCC inventory data: operational expenditure (OPEX) .....	138
Table D-5: LCC input data .....	139

## List of abbreviations and units

ACA	Catalan Water Agency
ANCS	Automatic Neural Net Control Systems
AOPs	Advanced Oxidation Processes
AR	Artificial Groundwater Recharge
ASR	Aquifer Storage and Recovery
ASTR	Aquifer Storage Transfer and Recovery
BW-UF	Backwash Water treatment by UF membranes
CAPEX	Capital Expenditure
CEB	Chemical Enhanced Backwashing
CED	Cumulative Energy Demand
CF	Characterisation Factor
DWTP	Drinking Water Treatment Plant
DOC	Dissolved Organic Carbon
ETP	Ecotoxicity Potential
FEP	Freshwater Eutrophication Potential
FeSO <sub>4</sub>	ferrous sulphate
GAC	Granular Activated Carbon
GWP	Global Warming Potential
HCMF	Hybrid Ceramic Membrane Filtration
HTP	Human Toxicity Potential
LCA	Life Cycle Assessment
LCC	Life Cycle Costing
LP	Low Pressure
LOQ	Limit Of Quantification
MAR	Managed Aquifer Recharge
MEP	Marine Eutrophication Potential
MF	Microfiltration
NPV	Net Present Value
OPEX	Operational Expenditure
PAC	Powdered Activated Carbon
PMF	Particulate Matter Formation
SVH	Sant Vicenç dels Horts

---

TAP	Terrestrial Acidification Potential
UF	Ultrafiltration
USPs	Unique Selling Propositions
WA5	Work Area 5
WSCF	Water Scarcity Footprint
WSI	Water Stress Index
WWTP	Wastewater Treatment Plant

d	day
h	hour
Mio.	Million
yr.	Year

# 1 Introduction

## 1.1 Overview and approach

Within the DEMEAU project, the objective of work area 5 (WA5) is the sustainability assessment and fostering of the market uptake of emerging water technologies in response to rising concerns about organic emerging contaminant contamination in wastewater and drinking water sources. The sustainability assessment is based on environmental, economic and social aspects and involves technologies to inactivate and/or remove emerging contaminants from wastewater and drinking water (WA1: Managed Aquifer Recharge; WA2: Ceramic membrane filtration and automatic neural net control systems; and WA3: Advanced Oxidation) and to detect a wide range of emerging contaminants (WA4: Bioassays) in the effluent of wastewater and drinking water treatment plants. The analyses are based on concrete case studies from each respective work area.

In this document, environmental and economic footprints of emerging technologies for emerging contaminant removal are analyzed by environmental Life Cycle Assessment (LCA) and Life Cycle Costing (LCC) (chapters 3 to 6). Together with technology experts from respective work areas, relevant application areas and emerging contaminant removal efficiencies have been identified for each technology. Based on these analyses, Unique Selling Propositions (USPs) were formulated for each technology (chapter 7) to derive sound recommendations for implementation of the studied technologies taking into account (i) their technological readiness for market uptake, (ii) applicability to remove or (in the case of bioassays) detect specific emerging contaminants, and (iii) main environmental and economic improvements/drawbacks of the new technologies. Furthermore, key challenges in terms of environmental and economic impacts are summarized to highlight environmental and economic optimization areas for future research.

## 1.2 Investigated technologies

### 1.2.1 Managed Aquifer Recharge (MAR)

Managed Aquifer Recharge (MAR) uses natural soil and aquifer processes to treat, store and/or distribute water until potential subsequent recovery and (re-)use to satisfy different sectoral water demands. The maintenance of groundwater levels through MAR can also provide environmental benefits such as aversion of salt water intrusion or avoiding the drying of groundwater dependent ecosystems (e.g. wetlands). Natural soil-aquifer processes include biodegradation of organic matter, chemical processes (e.g. precipitation, oxidation) and physical processes (e.g. filtration, adsorption) which are due to the complex interplay on one hand less predictable than other treatment methods but on the other hand also have a high buffer potential. DEMEAU explores current MAR systems and develops design, operational and risk management recommendations involving stakeholders such as utilities and authorities. Apart from establishing recommendations for current MAR systems, several innovative MAR designs are studied in their life-cycle impacts at different sites:

- **CS1.1 - Pilot-scale AOP as MAR pre-treatment:** The pre-treatment of influent water by Advanced Oxidation Processes (AOP) such as ozonation followed by hydrogen peroxide ( $O_3/H_2O_2$ ) or in addition with UV ( $O_3/H_2O_2/UV$ ) before infiltration were investigated at the drinking water treatment plant (DWTP) of Dunea in the Netherlands.
- **CS1.2 - Pilot-scale additional organic reactive layer:** An additional organic reactive layer to degrade organic emerging contaminants by biological processes was tested in a MAR scheme with pond infiltration in Sant Vicenç dels Horts in Spain and was compared to other technological alternatives for groundwater recharge.

### 1.2.2 Hybrid Ceramic Membrane Filtration (HCMF) and Automatic Neural Net Control Systems (ANCS)

Current state-of-the-art membranes are usually fabricated from polymers. While ceramic membranes are currently more expensive than polymeric membranes, their higher mechanical strength, longer lifetime and backwash efficiency may provide significant improvements in terms of costs and environmental impact considering the entire lifecycle of the product. Automatic neural net control, which can help to optimize performance and minimize chemical and energy demand, is a tool to decrease operational and investment costs for ceramic membrane filtration, which are still main barriers for its implementation. The following case studies were assessed by LCA and LCC:

- **CS2.1 - Pilot-scale Hybrid Ceramic Membrane Filtration (HCMF) for secondary WWTP effluent:** Pilot tests of powdered activated carbon (PAC) adsorption followed by ceramic ultrafiltration membrane systems were carried out at the WWTP Birs in Birsfelden, Switzerland, to polish secondary effluent.
- **CS2.2 - Pilot-scale ANCS to optimize membrane operation:** The potential application of an ANCS system for optimisation of membrane operation in terms of energy and chemicals demand is analysed for the drinking water treatment plant at WAG (Roetgen/Germany) at a UF membrane plant for backwash water treatment.

### 1.2.3 Advanced Oxidation Processes

While oxidative processes have a long history to disinfect the effluent of WWTPs and drinking water, several advanced oxidation processes now exist to provide further treatment which includes the inactivation and/or removal of emerging contaminants. Ozonation with subsequent biological filtration can significantly reduce emerging contaminants in the effluent, but has a high energy consumption and worker safety precautions have to be taken. Advanced Oxidation Processes (AOPs) have been mainly used for industrial wastewater production and only at lab scale for municipal wastewater. Innovative aspects of advanced oxidation in DEMEAU include the following case studies which are analysed with LCA and LCC:

- **CS3.1 - Full-scale ozonation for emerging contaminant removal in tertiary wastewater treatment:** The first full scale ozonation at WWTP Neugut in Switzerland for advanced emerging contaminant removal is analysed based on first operational data from full-scale operation.
- **CS1.1 - Pilot-scale AOP combined with MAR for drinking water treatment:** See section 1.2.1.

### 1.2.4 In-vitro bioassays

In-vitro bioassays are effect-based tools that can detect wide ranges of pollutants based on their genotoxicity, mutagenicity and their interference with the endocrine system in mammals. DEMEAU will identify (primarily *in vitro*) bioassays which are sensitive for the effects of a wide range of emerging contaminants and select appropriate bioassays in terms of cost-efficiency. Innovative aspects of bioassays considered in DEMEAU LCA and LCC include their potential to substitute chemical analysis in regular water quality monitoring:

- **CS4.1 - In vitro bioassays as cost-effective integration into chemical-analytical monitoring.** This case study estimates the savings potential of bioassays as screening tool in regular monitoring of source and product water at Waternet in the Netherlands.



## 2 Methods

This chapter provides a brief description of the general methodology for LCA and LCC which was used in DEMEAU. Further details and a step-by-step description of the entire sustainability assessment can be found in DEMEAU deliverable D51.2 (Remy et al. 2015).

### 2.1 Life Cycle Assessment (LCA)

Life Cycle Assessment (LCA) was used to quantify potential environmental impacts and benefits of technologies studied in DEMEAU based on process data of case studies and to compare these technologies to existing reference technologies, if applicable. The quantification was based on environmental indicators which on one hand reflect induced impacts of a given technology by process requirements such as energy and chemicals demand, carbon and water footprint, toxicity, etc., and on the other hand avoided impacts through the removal of emerging contaminants such as reduction of aquatic ecotoxicity and reduction of the risk of human contamination. Induced impacts derive from inputs during installation of a technology (e.g. building materials, type and source of energy required, etc.) and its operation (e.g. chemical input, electricity consumption, etc.) and disposal. Avoided impacts derive from the process performance of a technology and refer to the inactivation and/or removal efficiencies for emerging contaminants and the avoidance of hazardous by-products entering ecosystems or drinking water supply networks. An Excel data collection template has been used for LCAs in order to inform about data needs at case study level and assure a transparent approach.

#### 2.1.1 USEtox™ model for emerging contaminants

Currently, the modelling of impacts of emerging contaminants on the environment and public health within the LCA framework is still limited in terms of substance coverage. In order to compare impacts of drinking water and wastewater treatment plant emissions with the overall impact of a given technology as well as evaluate the benefits and impacts of implementing emerging pollutants treatment technologies, so called 'characterisation factors' (CFs) for emissions of toxic substances have to be used. Within DEMEAU WA5, these characterisation factors will be developed and integrated in the consensual USEtox™ model evaluating toxic impact.

### 2.2 Life Cycle Costing (LCC)

Life Cycle Costing (LCC) assesses all financial costs related to a product or service over the entire life cycle, from production over use until disposal – especially for products that have long life times and/or high maintenance, use or disposal costs which applies to many water technologies. In combination with LCA, LCC can serve to address the economic dimension of sustainability and is an instrument to support decision making. Input data include general requirements (e.g. service life for setup phase, operating phase and removal phase, discounting rates) and cost drivers (e.g. personnel cost, material, services, assets, financing, taxes and dues). Similar to LCA, an Excel data collection template were used. An LCC assessment helps to find favorable cost relationships taking into account the time of financial flows over service life years. The template included all costs related to individual life cycle stages (setup, operating, removal) and main outputs are cash values of life cycle costs, annual amounts of annuity, break-even analysis per investment and decision support for 'best investment'.

### 2.3 Selection of case studies

Case studies for LCA and LCC analysis were selected among project partners in the DEMEAU consortium and their willingness to supply input data (process data, operational and capital costs) for this purpose. Finally, six case studies of four different application areas (managed aquifer recharge, advanced oxidation, hybrid membranes, and bioassays) were selected and assessed in LCA and LCC.

### 3 Managed Aquifer Recharge (MAR)

#### 3.1 Technology description and relevant application areas

MAR is an umbrella term for different processes in which water is intentionally introduced into an aquifer (Dillon et al. 2009). The main objectives are:

- to replenish groundwater resources and store excess water for times of less water availability,
- to introduce an additional barrier for purification of water from different sources,
- to establish a hydraulic barrier (e.g. against sea-water intrusion).

Common MAR techniques in Europe include (see Figure 3-1):

- **Enhanced infiltration** which relies on gravitational infiltration and percolation and includes surface spreading methods such as infiltration ponds and basins, point or line recharge for instance through borehole infiltration and in-channel modifications
- In **induced bank filtration** surface water infiltration is induced by pumping from a nearby well where the river or lake bank fulfils water treatment functions
- **Well injection** is applied where the aquifer is covered by strata with a low permeability
- **Enhanced groundwater storage** includes sub-surface dams and rainwater harvesting.

Since the 19<sup>th</sup> century, bank and dune filtration have been applied as a first barrier within the drinking water treatment chain in England, Germany, France, and the Netherlands. The most common and widely used methods for artificial groundwater recharge (AR) are infiltration ponds (Asano et al. 2007). These simple surface spreading basins provide added benefits of treatment in the vadose zone of the soil and subsequently in the aquifer. An alternative for recharge are infiltration wells if geological or ecological conditions or limited space prohibit the use of infiltration ponds.

In most applications, MAR is intended to act as a buffer in terms of water availability (quantity) and water quality. In general, the level of knowledge of natural treatment systems, notably in aquifers, is not as high as in engineered systems, because the biogeochemical environment in aquifers that modify water quality will vary in space and time. The heterogeneity of the system strengthens its buffer potential on the one hand, but makes it more difficult to describe and control the performance on the other hand.

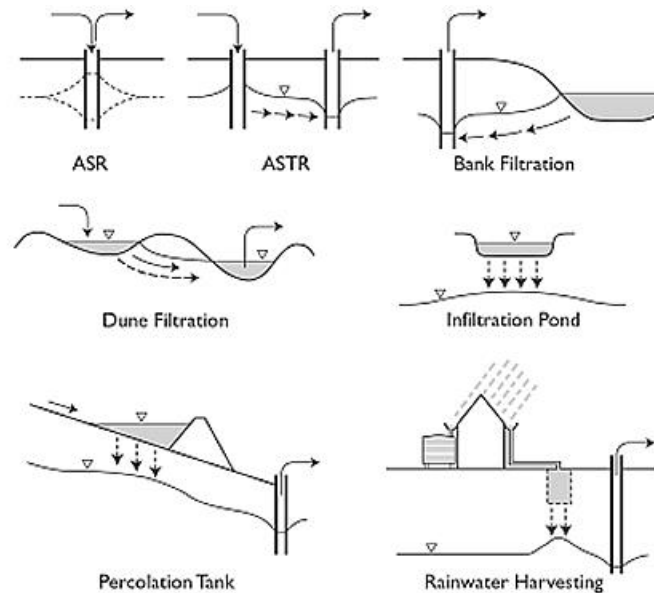

Figure 3-1: Most common MAR techniques (Gale and Dillon 2005) ASR: Aquifer Storage and Recovery; ASTR: Aquifer Storage Transfer and Recovery

The following site criteria have been identified as most relevant influencing the removal and/or degradation of emerging contaminants from source water in MAR schemes (Miret et al. 2013):

- MAR type
- Aquifer type
- Redox conditions
- Organic carbon content in the water
- Residence time
- Concentration of emerging contaminants
- Temperature.

The DEMEAU deliverable D12.1 ('Decision trees for MAR impact evaluation', Miret et al. 2013) provides more detailed information on this topic. The most important processes for MAR applications are the physical straining of particulate and particle-bound substances, lessening the effort for subsequent water treatment e.g. by removing pathogens, and the mixing of surface and groundwater with the creation of a groundwater stock. Adsorption to the aquifer matrix contributes to the elimination of organic substances and heavy metals. Although this does not completely remove the substances in most cases, peak loads are retarded and maximum concentrations reduced. Biological degradation in the subsurface contributes to the partial elimination of dissolved organic carbon and organic trace substances, occurring at varying extent depending on the redox potential in the aquifer. Key parameters affecting the capacity of MAR systems to remove emerging pollutants are MAR and aquifer type, redox conditions, organic carbon content in the water, residence time, concentration of emerging pollutants in the source water and temperature. These are further described in DEMEAU deliverable D12.1: 'Decision trees for MAR impact evaluation' (Miret et al. 2013). Depending on source water quality, pre-treatment of the infiltration water e.g. by coagulation and filtration is required to prevent clogging of the infiltration facilities and guarantee sustainable operation of the recharge system. Post-treatment of the recharged water after recovery, e.g. via activated carbon or ozonation, can be required if specific pollutants (e.g. pesticides or other trace organic substances) have to be further eliminated prior to water distribution.

### 3.2 Case studies conducted in DEMEAU

Within DEMEAU, several existing MAR sites were assessed in their key parameters for design, operation, and performance regarding water quality and quantity to elaborate design criteria and a classification system. Thus, design and operation of existing and future MAR sites can be optimized based on long-term experience of water utilities. Selected MAR sites for the sustainability assessment are listed below:

- **CS1.1 - Pilot-scale AOP as MAR pre-treatment:** The pre-treatment of influent water by Advanced Oxidation Processes such as ozonation followed by hydrogen peroxide ( $O_3/H_2O_2$ ) or in addition with UV ( $O_3/H_2O_2/UV$ ) before infiltration were investigated at the drinking water treatment plant (DWTP) of Dunea in the Netherlands.
- **CS1.2 - Pilot-scale additional organic reactive layer:** An additional organic reactive layer to degrade organic emerging contaminants by biological processes was tested in a MAR scheme with pond infiltration in Sant Vicenç dels Horts in Spain and was compared to other technological alternatives for groundwater recharge.

### 3.3 CS1.1: Pilot-scale AOP as MAR pre-treatment

#### 3.3.1 Case study description

In 1954, Dunea started the infiltration of surface water as an alternative source for rain water to restore and maintain the freshwater lens under the dune area, which has been used for drinking water production in the Den Haag area. The surface water is transported towards the dune area, infiltrated by infiltration ponds or deep infiltration wells and abstracted by shallow (17 m below sea level) and deep (50 m below sea level) wells. Before the surface water is suitable for infiltration, it needs to be pre-treated to remove suspended solids (especially for deep well infiltration to prevent rapid clogging of the well surface) and, in case of open infiltration, high concentrations of nutrients (e.g. phosphate). The quality standards for infiltration water also require that no contaminants foreign to the infiltration environment accumulate in the subsurface. This includes organic emerging contaminants, which are not sufficiently removed with conventional pre-treatment.

The treatment applied by Dunea is a typical multiple barrier treatment, characterized by an extensive infrastructure and subsequent treatment steps (Figure 3-2). The water is first collected in a dead end side stream of the Meuse River, acting as a process reservoir. At the beginning of this side stream, coagulation, flocculation and sedimentation take place through dosing of ferrous sulphate ( $FeSO_4$ ) in combination with aeration. At the water intake, the water is treated by microsieves (sieve width 35  $\mu m$ ) and transported in a pipeline for 27 km to Bergambacht where the water is filtered by dual media rapid filters and transported by two transport pipelines to the dune area, with a length of 46 and 57 km, respectively. In the dune area, water is infiltrated into the underground in open ponds, while a deep well injection facility can be operated as back-up. After a minimum residence time in the dunes of 20 days (average residence time is 120 days), the water is recovered in abstraction wells and pumped to post-treatment at three different locations (Scheveningen, Katwijk and Monster). Post-treatment consists of softening, dosing of powdered activated carbon (PAC), cascade aeration, rapid sand filtration, and finally slow sand filtration. The water is distributed to the customers without further disinfection.

**Key figures:**

Production capacity	
Scheveningen	51.5 Mio. m <sup>3</sup> /yr.
Katwijk	24.8 Mio. m <sup>3</sup> /yr.
Monster	7.9 Mio. m <sup>3</sup> /yr.
<u>Total</u>	<u>84.2 Mio m<sup>3</sup>/yr.</u>

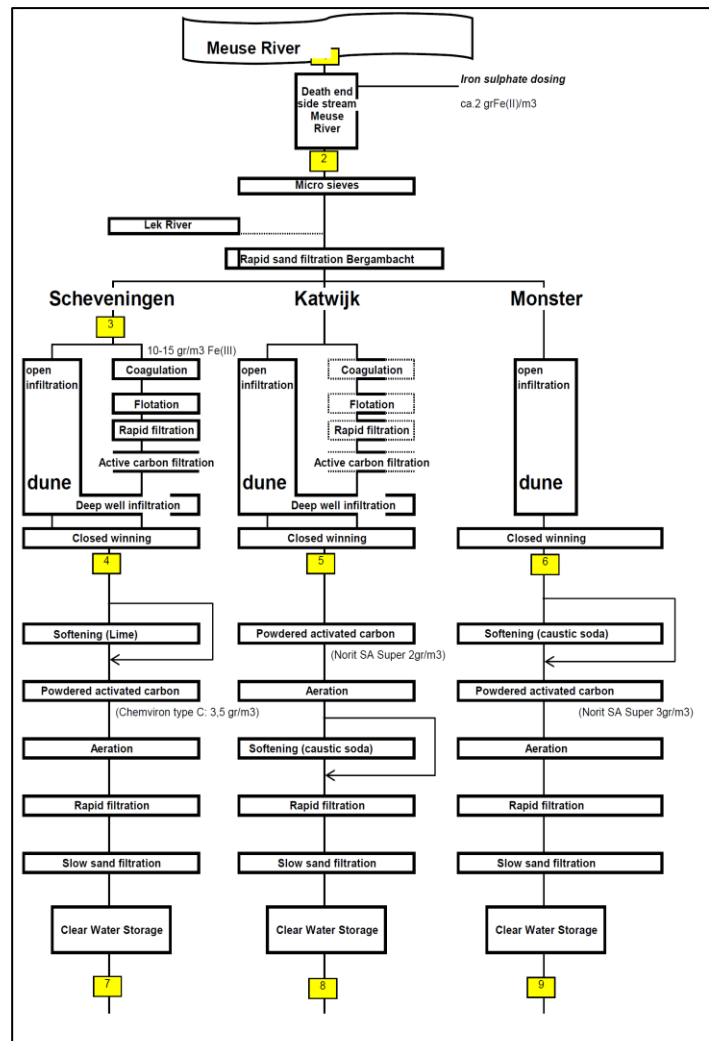

Figure 3-2: Flow chart of existing drinking water treatment scheme at Dunea (© WHO 2009)

In recent years, a variety of organic emerging contaminants (mainly pesticides and pharmaceuticals) has been detected in the low µg/L-range in the source water of river Meuse as a result from upstream activities. Since then, Dunea has performed research to extend the current multiple barrier treatment (e.g. pre-treatment, dune infiltration and recovery, post-treatment) with an advanced oxidation processes (AOP), situated at the sand filtration site in Bergambacht. The degradation of organic emerging contaminants as a result of advanced oxidation using different combinations of hydrogen peroxide, ozone, low pressure (LP) ultraviolet (UV) lamps has been assessed by means of pilot-scale (5 m<sup>3</sup>/h) experiments. The combined AOP (O<sub>3</sub>/H<sub>2</sub>O<sub>2</sub>/UV) was selected due to the best removal efficiency for the target compounds in the source water at reasonable costs. Other advantages of the combined AOP are limited by-product formation, especially bromate, and a future barrier against emerging contaminants encompassing a broad spectrum of properties.

The upgrade of the existing multi-barrier system at Dunea with two different configuration scenarios of AOP was analysed by LCA and LCC.

### 3.3.2 LCA and LCC: Definition of goals and scope

#### 3.3.2.1 Definition of goals

The goal of this LCA was to compare environmental profiles and toxicological benefits associated with the possible extension of the drinking water production system at Dunea by two possible AOP processes, compared to the current system. This LCA can serve as an example of a drinking water process using a MAR stage (dune infiltration) with adequate post-treatment, and it quantifies the additional impact of introducing an AOP process into the existing treatment scheme. The target group of this study consists of treatment plant operators, planners, engineers, and regulators in the field of drinking water production and regulation of MAR.

#### 3.3.2.2 Functional unit

The functional unit for this LCA is defined through the volume of water abstracted from Meuse River for drinking water production, i.e. “per m<sup>3</sup> water intake”. Quality requirements for the final drinking water product arise from the national regulations in Den Haag (“Drinkwaterbesluit”) and are fulfilled by all scenarios. Effective differences in drinking water quality in terms of organic emerging contaminants due to different treatment options (existing system, upgrade with AOP) are reflected in the respective LCA indicators for human toxicity.

#### 3.3.2.3 System boundaries and investigated systems

Due to the very site-specific pre-treatment of the river water at the intake (*in-situ* coagulation in dead end river stream), it was decided to exclude this pre-treatment and the following rapid sand filters at Bergambacht from the LCA. This LCA includes pumping of water from the pre-treatment to the dunes, dune infiltration and recovery, and post-treatment to drinking water (Figure 3-3). Electricity, chemicals, fuels and materials for operation and infrastructure are taken into account, as well as disposal of waste in post-treatment. Storage and distribution of drinking water are not part of this LCA.

In total, three scenarios are analysed in this LCA (Figure 3-4):

- S1 MAR + post-treatment (“status quo”):** this scenario describes existing drinking water treatment at Scheveningen. It includes pumping of raw water to the dune area, recharge and recovery, softening, dosing of powdered activated carbon (PAC), aeration, rapid sand filtration, and slow sand filtration. In addition to operational efforts, infrastructure is also included (pipeline for raw water transport, recovery wells, and treatment facilities). Sludge treatment and disposal (softening pellets, backwash of rapid sand filters) is included in the LCA.
- S2 O<sub>3</sub>/H<sub>2</sub>O<sub>2</sub> + MAR + post-treatment:** in this scenario, the existing treatment scheme is extended with an AOP process at the pre-treatment facility of Bergambacht. Here, filtered raw water is treated with ozonation and addition of H<sub>2</sub>O<sub>2</sub> (“hydrogen peroxide process”) for elimination of organic emerging contaminants. In addition to S1, this scenario includes electricity and materials for operation and construction of the AOP process.
- S3 O<sub>3</sub>/H<sub>2</sub>O<sub>2</sub>/UV + MAR + post-treatment:** this scenario is another option for an AOP process based on the combination of ozonation, dosing of H<sub>2</sub>O<sub>2</sub>, and UV light. This option has higher oxidative power than S2 and forms less by-products (bromate). In addition to S2, this scenario includes electricity and materials for operation and construction of the UV process.

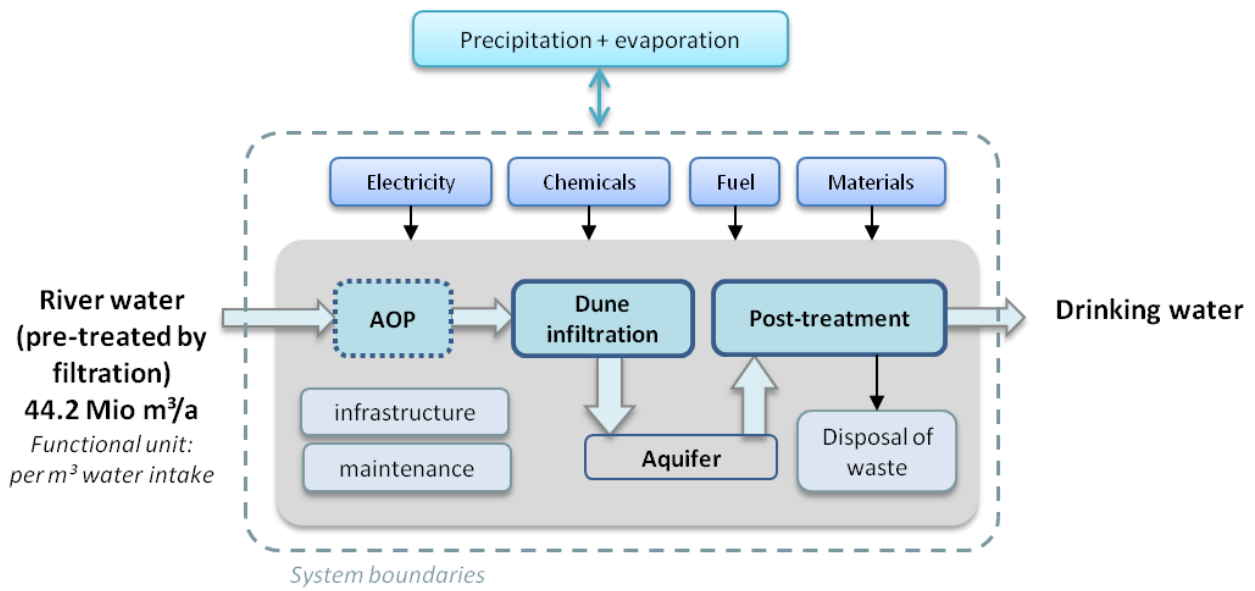

Figure 3-3: System boundaries of LCA/LCC study for drinking water treatment at Scheveningen (Dunea)

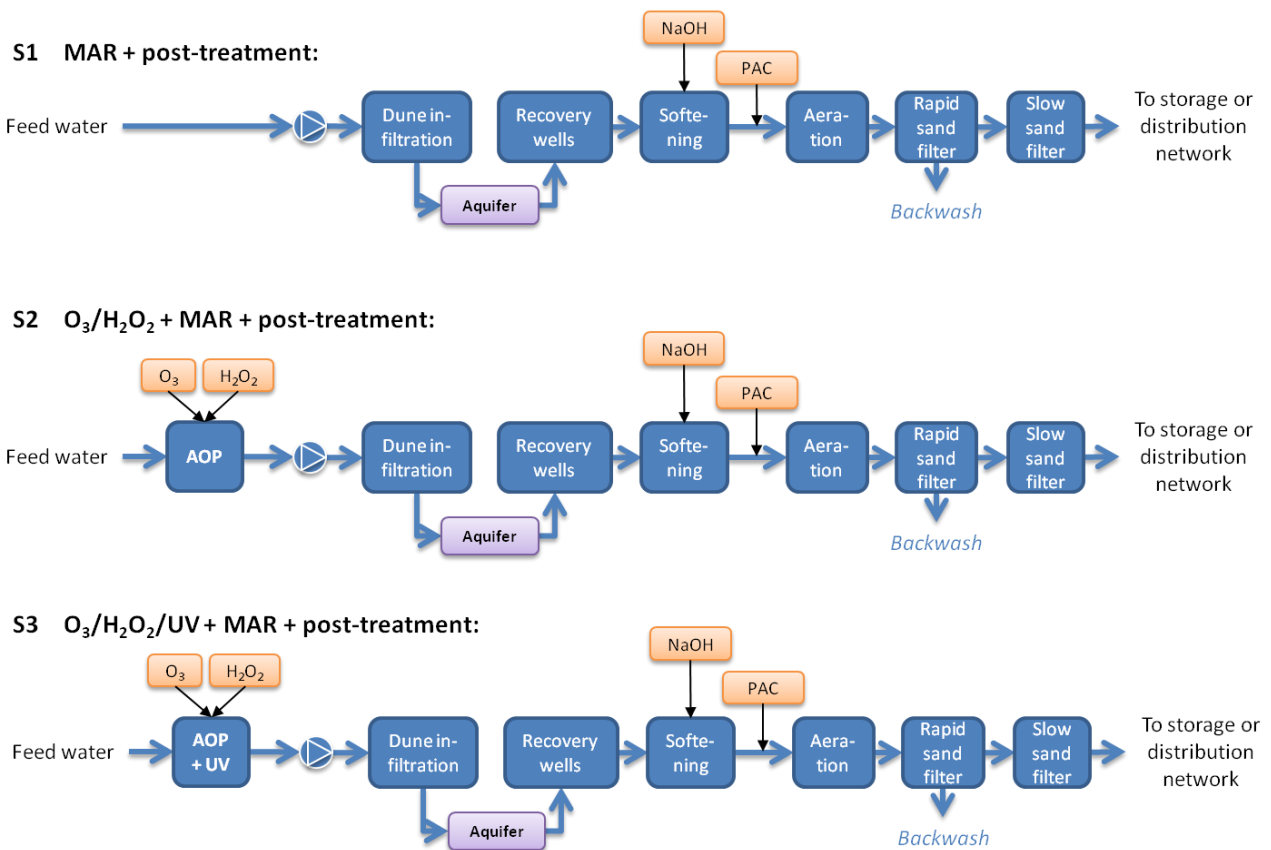

Figure 3-4: Scenarios for LCA and LCC of existing drinking water treatment (S1) and two alternatives with AOP pre-treatment (S2, S3) at Scheveningen



All scenarios include the treatment and disposal of waste from the post-treatment process, in particular the calcium carbonate pellets from softening and the backwash water from the rapid sand filters. The backwash water contains the PAC dosed ahead of the aeration step and is thickened with FeCl<sub>3</sub> before settling and drying in open ponds. Dried sludge is transported and re-used as construction material, whereas calcium pellets are transported to steel industry for material recovery.

### 3.3.2.4 LCA and LCC inventory

Inventory data for LCA and LCC were provided by Dunea as project partner within DEMEAU. Table 3-1 summarizes important LCA data for operation of the water treatment processes in terms of electricity and chemicals demand. While data of the existing system were collected from the full-scale processes, data for AOP options were based on extrapolation of pilot-scale trials at Dunea. Infrastructure data is summarized in Annex-A. For water balance of dune infiltration and recovery, it was assumed that 100% of infiltrated water can be recovered in the long-term average (no water losses or dilution with background groundwater).

Table 3-1: Operational data of the different scenarios for Scheveningen

		MAR + post-treatment (S1)	O <sub>3</sub> /H <sub>2</sub> O <sub>2</sub> + MAR + post-treatment (S2)	O <sub>3</sub> /H <sub>2</sub> O <sub>2</sub> /UV + MAR + post-treatment (S3)
<b>Annual intake volume</b>	<i>Mio m<sup>3</sup>/yr.</i>	44.2	44.2	44.2
<b>Infiltration area</b>	<i>ha</i>	100	100	100
<b>Electricity for pumping to dune infiltration</b>	<i>kWh/m<sup>3</sup></i>	0.2715	0.2715	0.2715
<b>Electricity for recovery wells</b>	<i>kWh/m<sup>3</sup></i>	0.117	0.117	0.117
<b>Electricity for filter backwash</b>	<i>kWh/m<sup>3</sup></i>	0.034	0.034	0.034
<b>Electricity for AOP</b>	<i>kWh/m<sup>3</sup></i>	-	0.106	0.406
<b>NaOH (50%)</b>	<i>mg/L</i>	82.6	82.6	82.6
<b>Powdered activated carbon (PAC)</b>	<i>mg/L</i>	3.5	3.5	3.5
<b>FeCl<sub>3</sub> (40%)</b>	<i>mg/L Fe</i>	1.0	1.0	1.0
<b>Liquid oxygen</b>	<i>mg/L</i>	-	15.6	15.6
<b>H<sub>2</sub>O<sub>2</sub> (30%)</b>	<i>mg/L H<sub>2</sub>O<sub>2</sub></i>	-	6.0	6.0

Disposal of calcium pellets (3'530 t/yr., 100% dry matter) was assumed with 100 km truck transport and no additional environmental impacts in disposal, allocating potential effects to the steel manufacturing process downstream. Filter backwash water (1.6% of intake) with spent PAC is thickened in ponds with FeCl<sub>3</sub> addition (natural dehydration) where backwash water infiltrates again into the MAR system (internal recycling). Dewatered sludge is collected (1'259 m<sup>3</sup>/yr.), transported by truck (100 km) and re-used in construction (neutral disposal, no impacts assumed).

For the AOP process, a dose of 1.5 mg/L of ozone was estimated in the AOP process in combination with dosing of 6 mg/L H<sub>2</sub>O<sub>2</sub>. The UV system uses low-pressure lamps with high output. A subsequent filter with granular activated carbon (GAC) is required to quench the residual H<sub>2</sub>O<sub>2</sub> after the AOP reactor, but the GAC run-time is expected to last 20 years due to the catalytic reaction.

For direct water footprint of the MAR systems, the local evaporation rate of 601 mm/yr. was used to calculate water losses by evaporation due to water storage in pond, taking into account the surface area of the dune infiltration system. Water stress index (WSI) of the local area in Scheveningen was estimated at 0.1001 (Pfister et al. 1999), which represents low water scarcity. However, the adjacent area of Scheveningen towards the south has higher water scarcity (WSI = 0.2981), which is used as “high-scarcity” scenario in WFP calculation. WSI for background processes is assumed with NL average (0.306) for electricity production and European average (0.31) for all other background processes. For indirect water consumption, data from Quantis Water database was used (Quantis 2011).

Investment and operational costs for all scenarios are summarized in Table 3-2. While operational costs for the existing system at Dunea are extracted from recent company data, investment costs for existing treatment train are best estimates from experts, as these processes have been installed many decades ago. The pipeline construction from the raw water filtration to the dunes (46 km) was not included. For the AOP scenarios, realistic cost estimates for full-scale AOP installations have been collected from the experts within Dunea, as these options are also assessed internally for potential installation in the coming years.

Table 3-2: Investment and operational costs for the different scenarios for Scheveningen

		MAR + post-treatment (S1)	O <sub>3</sub> /H <sub>2</sub> O <sub>2</sub> + MAR + post-treatment (S2)	O <sub>3</sub> /H <sub>2</sub> O <sub>2</sub> /UV + MAR + post-treatment (S3)
<b>Investment costs</b>				
<b>Dune infiltration</b>	<i>Mio €</i>	116	116	116
<b>Post-treatment</b>	<i>Mio €</i>	105	105	105
<b>AOP</b>	<i>Mio €</i>	-	22.4	42.0
<b>Operational costs</b>				
<b>Electricity</b>	<i>Mio €/yr.</i>	1.0	1.0	1.0
<b>Chemicals</b>	<i>Mio €/yr.</i>	1.0	1.0	1.0
<b>Operating Supplies</b>	<i>Mio €/yr.</i>	0.1	0.1	0.1
<b>Waste disposal</b>	<i>Mio €/yr.</i>	0.06	0.06	0.06
<b>Other</b>	<i>Mio €/yr.</i>	0.5	0.5	0.5
<b>Electricity AOP</b>	<i>Mio €/yr.</i>	-	0.4	1.5
<b>Chemicals AOP</b>	<i>Mio €/yr.</i>	-	0.3	0.3
<b>Maintenance AOP</b>	<i>Mio €/yr.</i>	-	0.06	0.4

Water quality data for raw water (pre-filtered river water) and drinking water was collected for a selection of organic and inorganic emerging contaminants (Table 3-3) from regular monitoring at Dunea. For organic emerging contaminants, additional effect of AOP treatment was estimated based on results of pilot trials at Dunea (Lekkerkerker-Teunissen 2012). For organic emerging contaminants, it can be seen that only 4 of 8 assessed substances are contained in drinking water in the ng/L range above their limit of quantification (LOQ). From these substances, two contaminants are affected by AOP pre-treatment (iopromide and sulfamethoxazole) in their final concentration in the drinking water.

For the inorganic emerging contaminants, many substances are already below their LOQ in the raw water and also in the drinking water, whereas others are reduced during dune infiltration and post-treatment. Arsenic is an exception here, as the concentration increases slightly during dune infiltration and recovery. This mobilization of geogenic As in the underground passage of water is currently assessed in the light of increasingly strict drinking water quality standards, but the As level in drinking water still conforms with current Dutch drinking water regulations.

Table 3-3: Water quality parameters of different scenarios in Scheveningen

Parameters		Pre-filtered river water	Drinking water after MAR + post-treatment (S1)	Drinking water after O <sub>3</sub> /H <sub>2</sub> O <sub>2</sub> + MAR + post-treatment (S2)	Drinking water after O <sub>3</sub> /H <sub>2</sub> O <sub>2</sub> /UV + MAR + post-treatment (S3)
<b>Organic emerging contaminants</b>					
Bezafibrate (BEZ)	[ng/L]	9	< LOQ	< LOQ	< LOQ
Carbamazepine (CAB)	[ng/L]	70	< LOQ	< LOQ	< LOQ
Diclofenac (DCF)	[ng/L]	20	< LOQ	< LOQ	< LOQ
Iopromide (IOP)	[ng/L]	230	10	7.3	7.3
Metoprolol (MET)	[ng/L]	38	< LOQ	< LOQ	< LOQ
Phenazone (PHZ)	[ng/L]	9	2	2	2
Sulfamethoxazole (SMX)	[ng/L]	42	15	3	3
Trimethoprim (TRI)	[ng/L]	8	2	2	2
<b>Heavy metals</b>					
Arsenic	[ng/L]	250*	1800	1800	1800
Barium	[ng/L]	30'100	14'600	14'600	14'600
Cadmium	[ng/L]	25*	10*	10*	10*
Chromium	[ng/L]	1'000*	500*	500*	500*
Copper	[ng/L]	1'500*	250*	250*	250*
Lead	[ng/L]	500*	250*	250*	250*
Nickel	[ng/L]	3'200	1600	1600	1600
Vanadium	[ng/L]	400	300	300	300

LOQ = Limit of quantification, \* below LOQ, estimated with 0.5 x LOQ

### 3.3.3 Results and discussion

#### 3.3.3.1 LCA impact assessment

Environmental impacts were assessed with a set of 11 indicators, representing specific areas of environmental concern. After an overview of all indicators, selected categories are discussed more in detail to reveal individual contributions of process stages to the total environmental impacts.

#### Total environmental impacts and benefits of all scenarios

The environmental profiles of all scenarios for the set of eleven indicators are shown relative to the baseline (S1 = 100%) in Figure 3-5. All indicators are dominated by background processes such as electricity production, chemicals, and infrastructure, because drinking water treatment is not associated with relevant direct emissions on-site at the plant. Some effects related to human toxicity are also affected by drinking water quality, as drinking water is directly consumed by humans and thus influences this indicator. For ecotoxicity, indirect effects from background processes are mostly compensated by water quality improvements (assuming drinking water contaminants as environmental emission). The water scarcity footprint also has some direct effects of the treatment, as water losses occur during dune infiltration by evaporation from the pond surface.

In general, electricity and chemicals demand for operation of the process dominate most impact categories, such as cumulative energy demand, global warming, acidification, and eutrophication. In these categories, the contribution of infrastructure is rather small (8-20%). Categories of human toxicity (cancer) and ecotoxicity have higher contribution of infrastructure (>74%) and lower operational contribution.

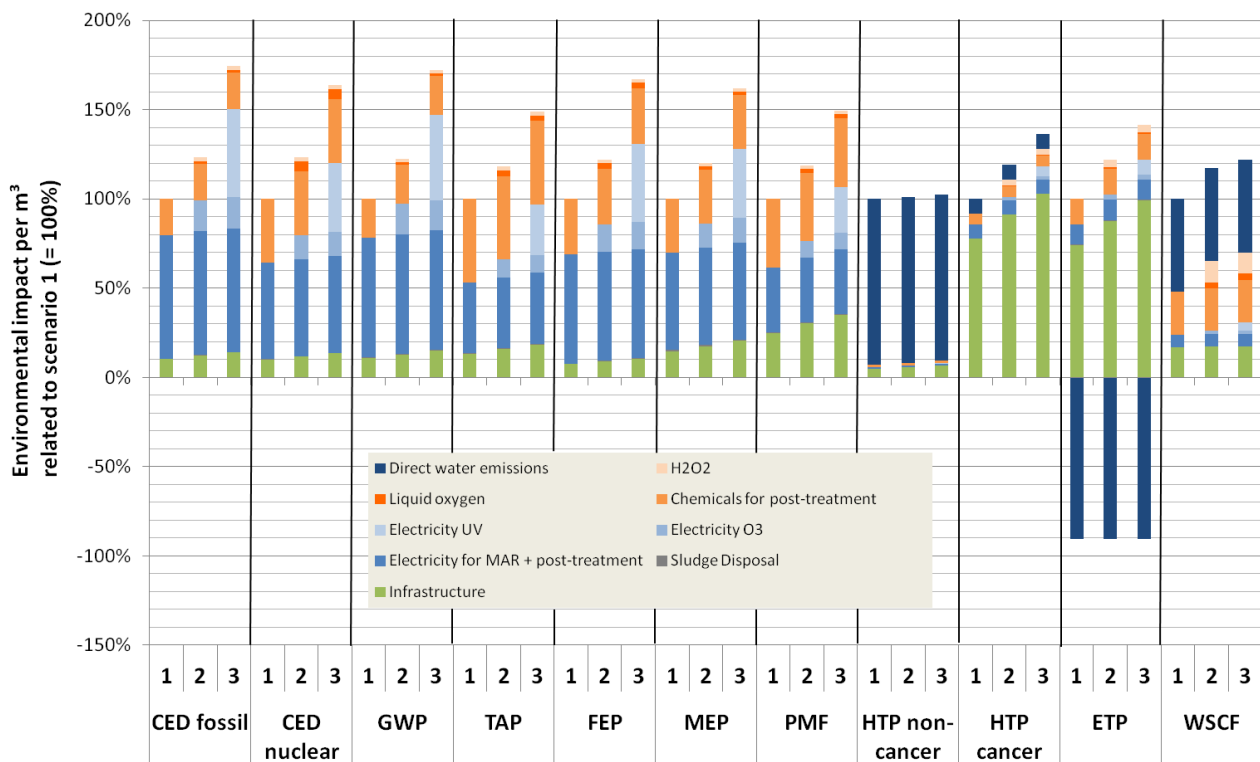
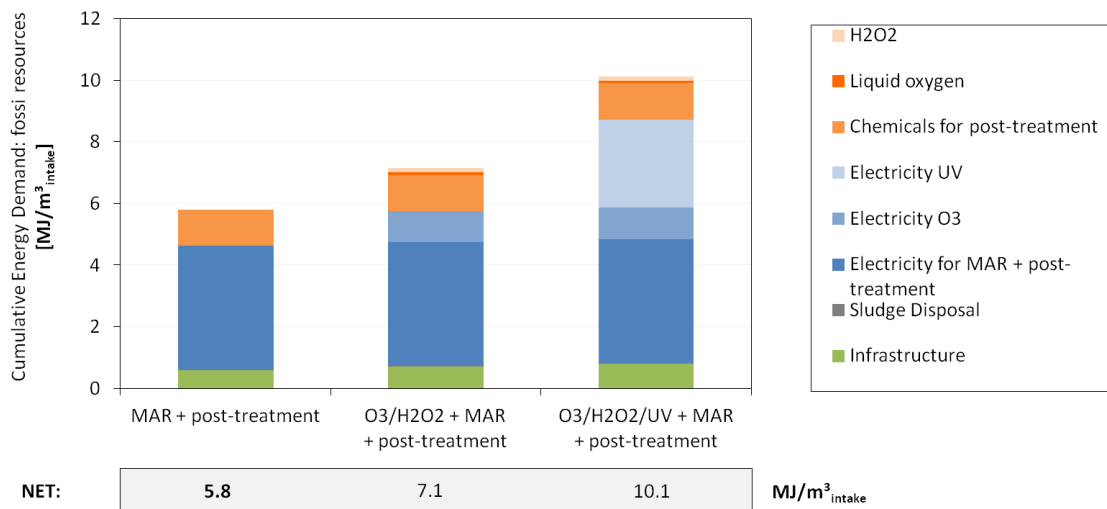

Figure 3-5: Environmental profiles of three scenarios (1: MAR + post-treatment, 2: O<sub>3</sub>/H<sub>2</sub>O<sub>2</sub> + MAR + post-treatment, 3: O<sub>3</sub>/H<sub>2</sub>O<sub>2</sub>/UV + MAR + post-treatment) related to scenario S1 (= 100%) for each respective indicator

Upgrading the existing process (S1) with an AOP process leads to considerable increase in all indicators, mostly due to additional demand in electricity, but also infrastructure. Whereas the implementation of a hydrogen peroxide process ( $O_3/H_2O_2$ ) in scenario S2 leads to an increase of 17-23% in most impact categories, the further addition of a UV-based process (S3) leads to a total increase of 22-74% compared to the existing system. This significant effect is caused by the high electricity consumption of the combined  $O_3/UV$ -process ( $406 \text{ kWh/m}^3$ ), which almost doubles the total electricity consumption of the existing process ( $423 \text{ Wh/m}^3$ ). Chemicals demand for AOP process ( $H_2O_2$ , liquid oxygen) does not contribute significantly to the overall impacts (2-12%). The additional infrastructure for the AOP process leads to some increase also in the toxicity categories (25%).

**Energy demand (fossil) and global warming potential**

Indirect effects of the drinking water production at Scheveningen in terms of energy demand and corresponding global warming potential are mainly related to the demand of electricity and chemicals for operation. Focussing on cumulative energy demand of fossil resources (Figure 3-6), the current treatment requires  $5.8 \text{ MJ/m}^3$  for treatment, mainly originating from electricity for treatment (69%) and chemicals (20%). With implementation of an AOP process, the energy demand rises to  $7.1 \text{ MJ/m}^3$  (+23%) with the hydrogen peroxide process (S2) and  $10.1 \text{ MJ/m}^3$  (+74%) with additional UV (S3). Again, the considerable additional energy demand of the AOP process becomes evident, increasing resource consumption of drinking water production significantly.



**Figure 3-6: Cumulative energy demand (fossil) of drinking water treatment scenarios in Scheveningen**

This effect is also visible in the indicator for global warming potential, where the existing treatment leads to emissions of  $0.43 \text{ kg CO}_2\text{-eq/m}^3$  due to electricity and chemicals production. Adding an AOP process increases greenhouse gas (GHG) emissions to  $0.52 \text{ kg CO}_2\text{-eq/m}^3$  (+23%) for the hydrogen peroxide process and to  $0.74 \text{ kg CO}_2\text{-eq/m}^3$  (+64%) for hydrogen peroxide and UV. For the total drinking water production process in Scheveningen, this increase in GHG emissions amounts to  $4240 \text{ t CO}_2\text{-eq/yr.}$  for hydrogen peroxide and  $13700 \text{ t CO}_2\text{-eq/yr.}$  for the hydrogen peroxide/UV.

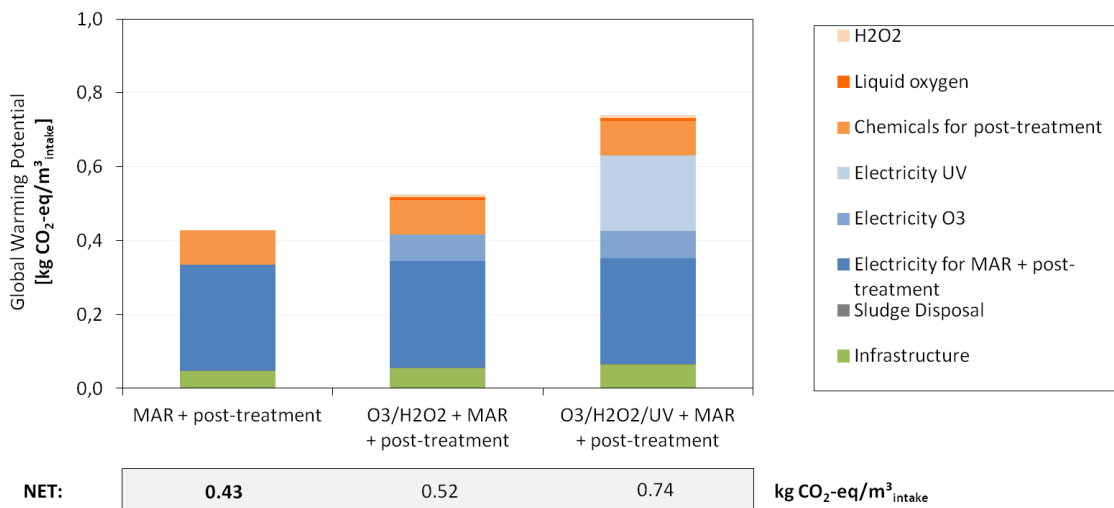

Figure 3-7: Global warming potential (100 years) of drinking water treatment scenarios in Scheveeningen

### Human toxicity

Impacts of drinking water production on human health via potentially toxic substances are two-fold: direct effects originate from the consumption of drinking water and potential contaminants, whereas indirect effects are caused by emissions occurring in background processes such as the production of electricity/chemicals/infrastructure. For direct effects, new and existing LCIA characterization factors for toxicity for emerging contaminants (Remy et al. 2015) and heavy metals have to be recalculated to reflect the direct intake of drinking water by humans. Usually, LCIA factors assess the emission of substances into freshwater, from where they are transferred in the exposure model via a certain intake fraction (in the range of <0.1%) to humans. For direct drinking water consumption, this intake fraction is corrected in this study to 1%, assuming a direct consumption of 1% of produced drinking water (e.g. a maximum of 1 L from 100 L water demand per person and day). For indirect emissions, existing LCIA factors are taken without modification.

The individual contribution of all effects to the overall impact of human toxicity (non-cancer) is shown in Figure 3-8. For the existing system (S1), indirect effects account for 39\*E-9 comparative toxic units (CTU<sub>h</sub>) or only 7% of total human toxicity potential. Comparing the emerging contaminant concentrations in raw water (= pre-filtered river water) and final drinking water, the existing treatment reduces 8 emerging contaminants and 7 metals (cf. Table 3-3) which is reflected in a reduced potential for human toxicity (-68\*E-9 CTU<sub>h</sub>) for these compounds. However, the geogenic increase of As levels in the sub-surface during dune infiltration is also reflected in this indicator category, accounting for an increase of human toxicity potential of 597\*E-9 CTU<sub>h</sub> in this study. Due to the relatively high characterization factor for human toxicity of As, the increase in As concentration in drinking water dominates the effects on human toxicity (non-cancer) and contributes with 93% to the overall impacts. Summarizing the effect of treatment on drinking water quality, the additional input of As “off-sets” the reduction of the other emerging contaminants in the final drinking water leads to a higher toxicity after treatment.

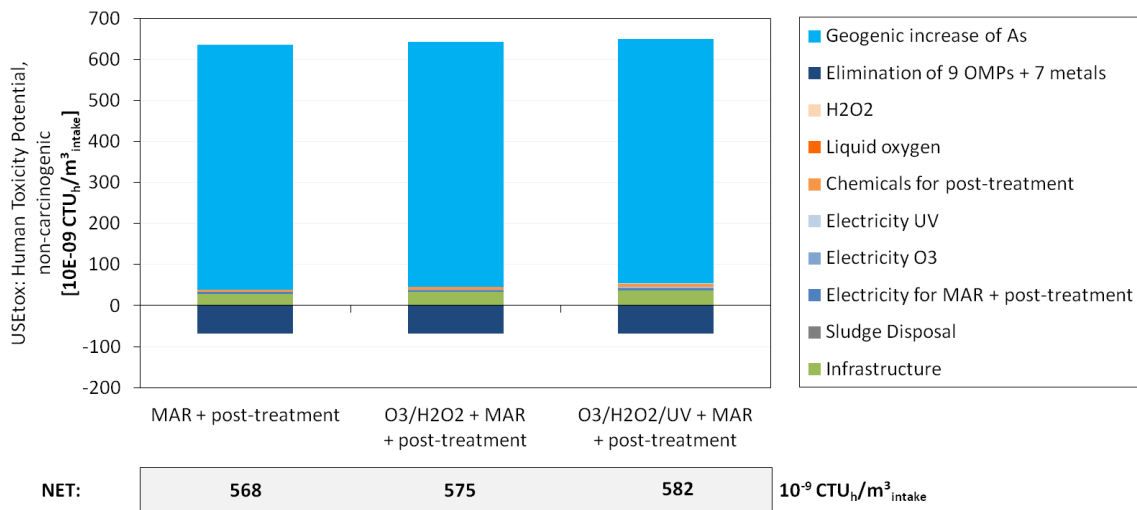

Figure 3-8: Human toxicity potential (non-carcinogenic) of drinking water treatment scenarios in Scheveningen

The addition of an AOP process leads to a further reduction of potentially toxic emerging contaminants in drinking water, but this effect is not adequately reflected in this LCA study. From the eight emerging contaminants that are evaluated for human toxicity, four compounds are already below LOQ in the conventional process (cf. Table 3-3), and only concentrations of iopromide and sulfamethoxazole in drinking water are affected in the low ng/L-range by introducing an AOP process. Comparing the calculated toxicity potential of emerging contaminants and heavy metals, it is obvious that metal removal or increase (for As) dominates this impact category (Figure 3-9). Potential health impacts from metal concentration in drinking water are higher than impacts from emerging contaminants by a factor of 10-100.

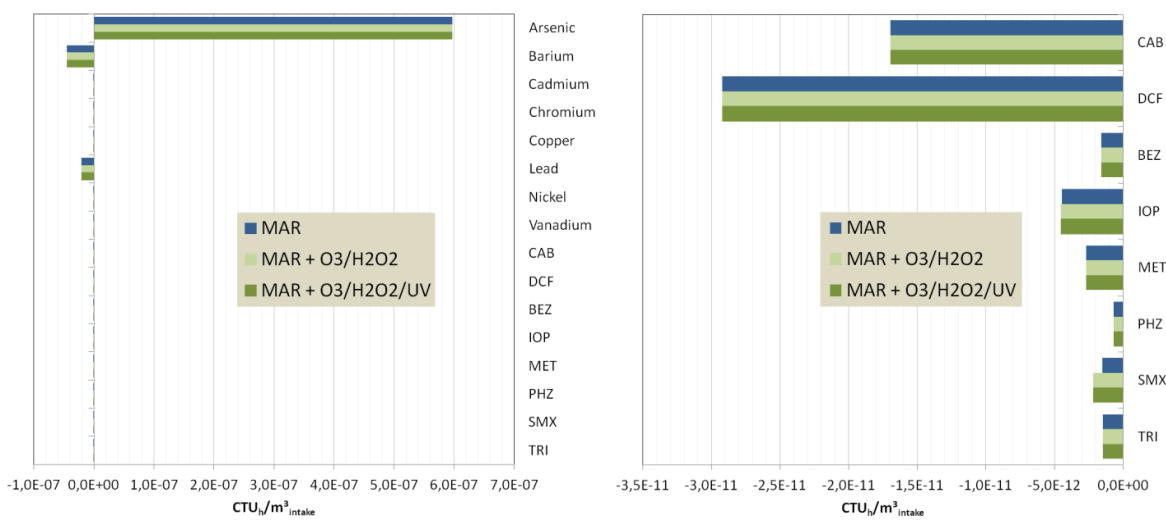

Figure 3-9: Changes in human toxicity (non-cancer) due to drinking water consumption based on 8 heavy metals and 8 emerging contaminants (left) and 8 emerging contaminants only (right) for all three scenarios (note the different scales on x-axis; abbreviations as in Table 3-3)

When discussing the results in this impact category, it has to be kept in mind that LCA quantifies only potential effects of substances and may overestimate metal effects by assuming an infinite residence time in the environment or humans. If more emerging contaminants would be included in the LCA and

impact assessment, the benefits of adding an AOP process for mitigating potential effects of emerging contaminants on human health may become more obvious. Finally, LCA is not a suitable tool to realistically evaluate site-specific potential hazards from drinking water consumption, as LCIA factors rely on a global fate and effect model with simplified assumptions.

### Water scarcity footprint

The scarcity-weighted water footprint of the existing process accounts for 2.6 L-eq/m<sup>3</sup> in the baseline scenario (Figure 3-10). 48% of this water scarcity footprint (WSCF) is due to background processes, while 52% is caused by direct evaporation of water at the dune infiltration system. Compared to the produced water volume (1 m<sup>3</sup>), the WSCF accounts for only 0.26% of relative water losses, which is partly due to the low water scarcity index in the Scheveningen area (WSI = 0.1) and NL (WSI = 0.3).

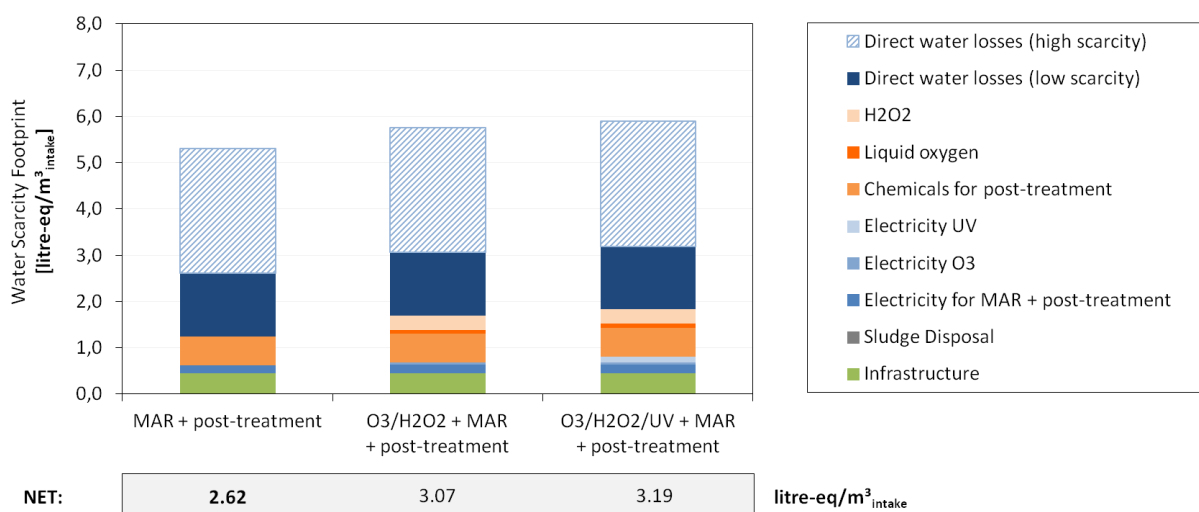

Figure 3-10: Water scarcity footprint of drinking water treatment scenarios in Scheveningen

If higher water scarcity is assumed (e.g. south of Scheveningen, where the WSI is 0.3), direct water losses are assessed higher in the WSCF, leading to a total loss of 5.3 L-eq/m<sup>3</sup> or 0.53%. Addition of an AOP process does not increase WSCF significantly, adding only 17-22% in scenario S2 or S3. Overall, the WSFP of drinking water production at Scheveningen seems reasonably low, because local and regional water scarcity is not assessed as very severe in the water stress index metrics (Pfister et al 2009). However, effective water shortages on a local scale and temporal scarcity are not well reflected in this indicator, which may require further research in this area.

#### 3.3.3.2 LCC assessment

For life cycle costing, capital (CAPEX) and operational costs (OPEX) of the three scenarios (MAR + post-treatment, O<sub>3</sub>/H<sub>2</sub>O<sub>2</sub> + MAR + post-treatment, O<sub>3</sub>/H<sub>2</sub>O<sub>2</sub>/UV + MAR + post-treatment) were collected and will now be presented in reference to the annual volume of water intake [EUR/m<sup>3</sup> intake/yr. or EUR/m<sup>3</sup> intake].

#### Capital costs for infrastructure

The capital expenditure including all construction costs for the three drinking water treatment scenarios at Scheveningen can be split into three major components: MAR system (dune infiltration,



transport of water from intake and pumping of recharged water to surface before before post-treatment); post-treatment; and potential AOP pre-treatment. The first part of the current system, the dune infiltration, costs about 116 Mio. EUR or 2.61 EUR/(m<sup>3</sup><sub>intake</sub>/yr.), which is approximately half of the total MAR CAPEX. The other half is then due for the post-treatment steps (softening, PAC dosing, aeration and sandfiltration, slow sandfiltration). Related to the annual volume of water intake, investment costs for MAR and post-treatment are in the end about 5.0 EUR/(m<sup>3</sup><sub>intake</sub>/yr.) (Figure 3-11).

Adding an advanced process prior to this will increase the initial investment costs per m<sup>3</sup><sub>intake</sub> up to 5.5 EUR/(m<sup>3</sup><sub>intake</sub>/yr.) for drinking water treatment with an O<sub>3</sub>/H<sub>2</sub>O<sub>2</sub>-process or respectively 5.9 EUR/(m<sup>3</sup><sub>intake</sub>/yr.) for drinking water treatment with an O<sub>3</sub>/H<sub>2</sub>O<sub>2</sub>/UV-process.

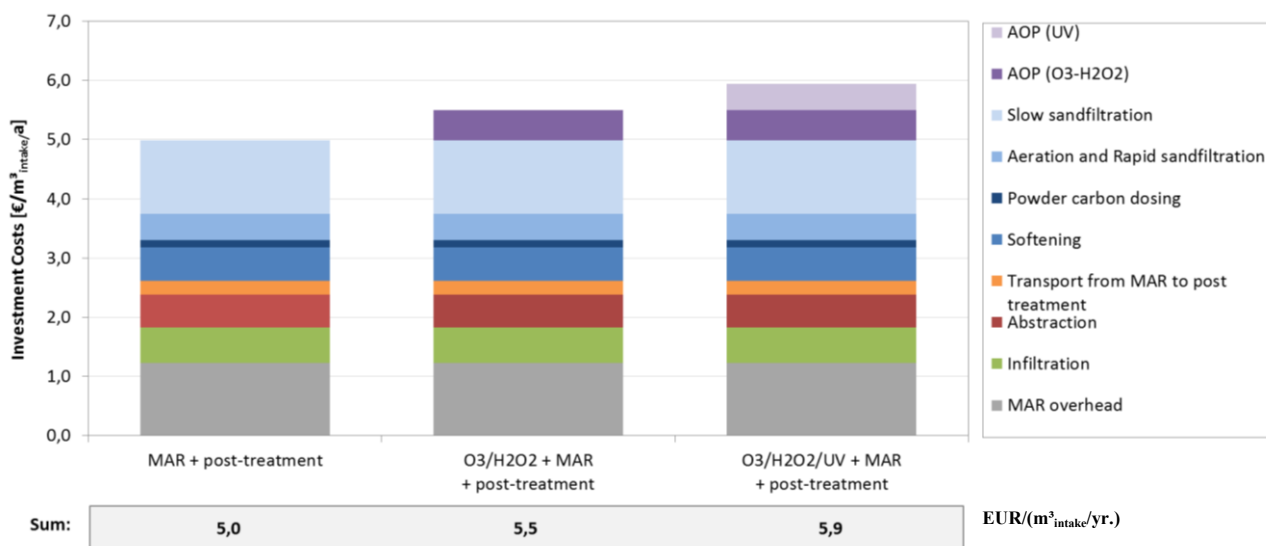

Figure 3-11: CAPEX per system capacity of drinking water treatment scenarios in Scheveningen

### Operational costs

The operational expenditure of the MAR and post-treatment are dominated by chemicals (39%), electricity (36%), and personnel costs (19%). It is important to notice that the water pumping from MAR to post treatment and chemical costs during the aeration and rapid sand filtration stage induce 70% (0.04 EUR/m<sup>3</sup><sub>intake</sub>) of the overall operational costs (0.06 EUR/m<sup>3</sup><sub>intake</sub>) for MAR and post-treatment. For water transport 0.02 EUR/m<sup>3</sup><sub>intake</sub> are needed (84% of electricity costs) and 0.02 EUR/m<sup>3</sup><sub>intake</sub> (93% of chemical costs) for powdered activated carbon dosing. The operation of the other stages (infiltration, abstraction, softening, PAC dosing, sludge treatment and disposal, slow sandfiltration) together only costs the remaining 0.02 EUR/m<sup>3</sup><sub>intake</sub> (0.8 Mio EUR/yr.).

Operating an ozonation stage will increase the specific costs of operation by 0.02 – 0.05 EUR/m<sup>3</sup><sub>intake</sub> (0.7 - 2.2 Mio EUR/yr.) which is an additional share of 26–83% to the initial operating costs of 0.06 €/m<sup>3</sup><sub>intake</sub> (Figure 3-12). The operation of the O<sub>3</sub>/H<sub>2</sub>O<sub>2</sub>/UV AOP system is 315 % more expensive than the operation of the O<sub>3</sub>/H<sub>2</sub>O<sub>2</sub> system caused by a four times higher energy consumption and eight times maintenance costs for the UV/O<sub>3</sub>/H<sub>2</sub>O<sub>2</sub>-process.

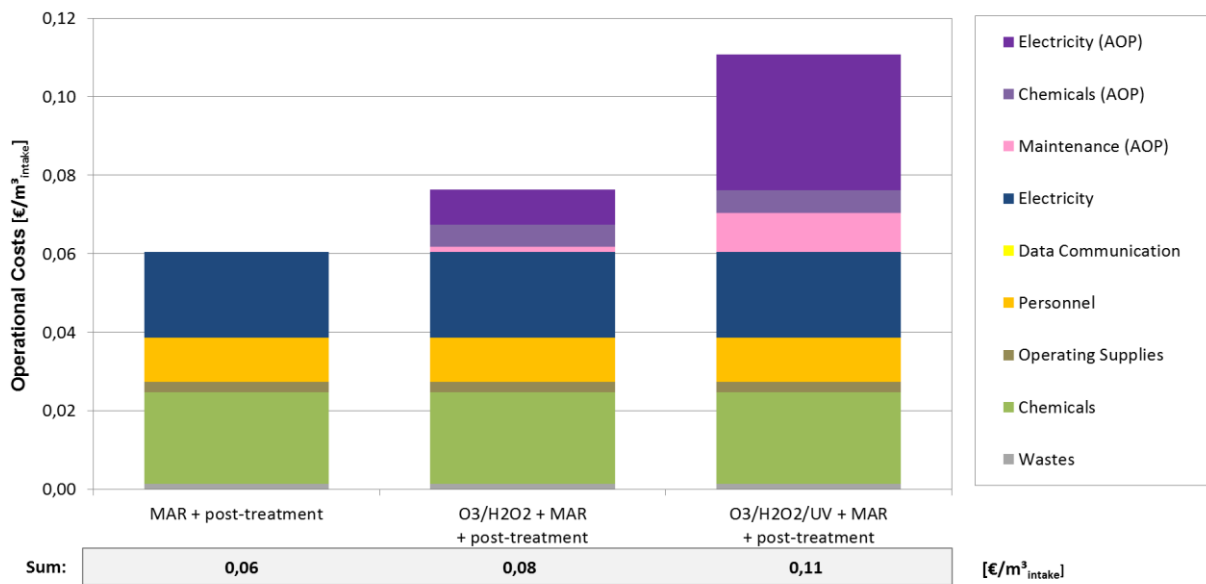

Figure 3-12: OPEX per m<sup>3</sup> water intake of drinking water treatment scenarios at Scheveningen

### Net present value over the life cycle

Calculating the net present value over the estimated system lifetime again visualizes this cost difference between the scenarios. After a course of 30 years the NPV of the basic scenario without AOP is about 264 Mio EUR, which is 0.20 EUR/m<sup>3</sup><sub>intake</sub>. Costs for the drinking water treatment processes with ozonation are 16–37% higher (0.23 EUR/m<sup>3</sup><sub>intake</sub> for O<sub>3</sub>/H<sub>2</sub>O<sub>2</sub>+MAR+post-treatment and 0.27 EUR/m<sup>3</sup><sub>intake</sub> for UV/O<sub>3</sub>/H<sub>2</sub>O<sub>2</sub>+MAR+post-treatment (Figure 3-32).

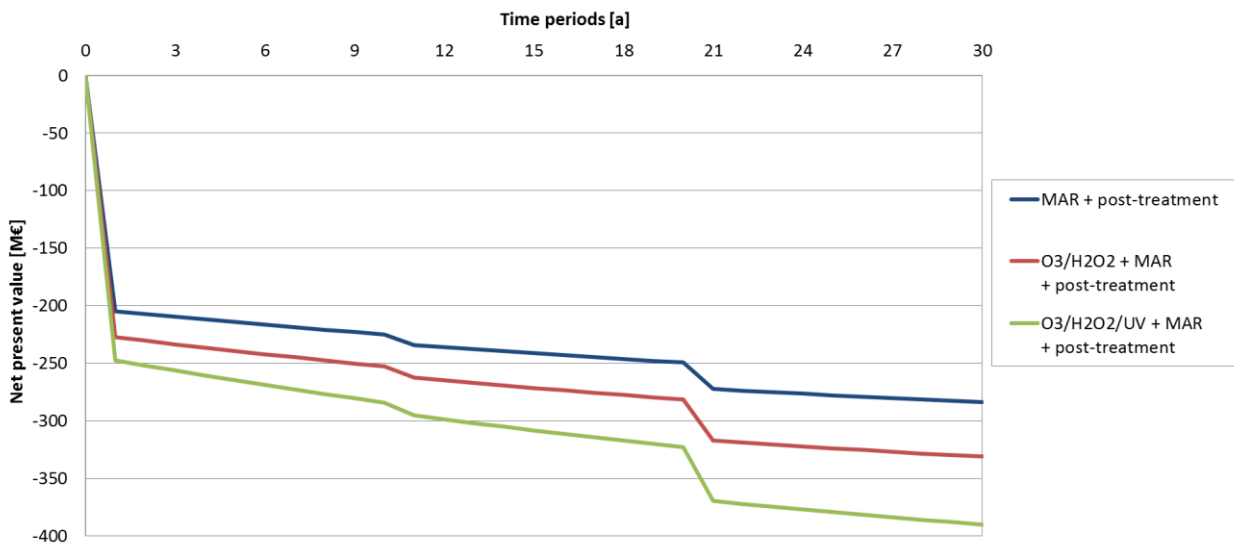

Figure 3-13: Net present value (NPV) of drinking water treatment scenarios at Scheveningen over time

### Sensitivity analysis

Sensitivity analyses of the results prove that the results presented above are robust against variations in the system’s lifetime (Figure 3-1) and variations of inflation and discounting rates (Table 3-4).

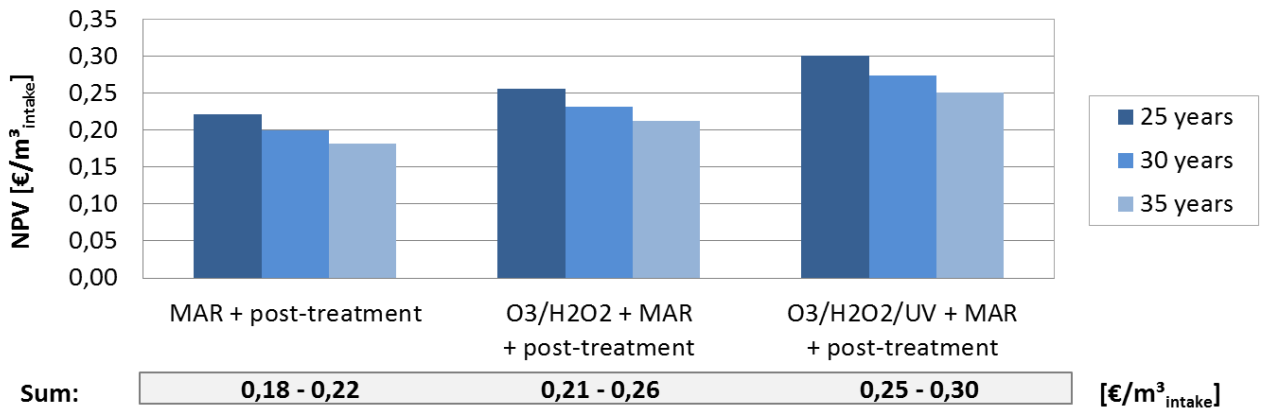

Figure 3-14: NPV per m³ water intake of drinking water treatment scenarios at Scheveningen under varying system lifetimes

Sensitivity checks regarding the influence of the system’s lifetime show that the cost relation between the different scenarios is almost equal independently of the lifetime assumed (25 years / 30 years / 35 years). The general effect of a decreasing trend in costs is mainly due to MAR overhead. As it is only fixed costs considered in this category, the MAR overhead is distributed over the volume of water intake which increases proportionally to the system’s lifetime assumed. So, the longer the lifetime, the smaller the specific costs in this category.

Modifications of the discounting rate (i = 2% / 3% / 5%) as well as inflation rates on energy, operating supplies and personnel costs lead to similar conclusions. As the impact of MAR infrastructure is very high compared to the costs of the AOP systems, the cost difference between the status quo scenario “MAR + post-treatment” and the scenarios with AOP slightly decreases with a higher discounting rates assumed. Due to the fact that the UV-system causes disproportionately high costs for operation and maintenance in relation to the other scenarios considered, the costs for this scenario are stronger affected by inflation than the others.

Table 3-4: NPV per m³ water intake of drinking water treatment scenarios at Scheveningen per m³ water intake under varying system lifetimes

	MAR + post-treatment	O <sub>3</sub> /H <sub>2</sub> O <sub>2</sub> + MAR + post-treatment	O <sub>3</sub> /H <sub>2</sub> O <sub>2</sub> /UV + MAR + post-treatment	MAR + post-treatment	O <sub>3</sub> /H <sub>2</sub> O <sub>2</sub> + MAR + post-treatment	O <sub>3</sub> /H <sub>2</sub> O <sub>2</sub> /UV + MAR + post-treatment
time horizon [30 a]	[€]	[€]	[€]	€/m³ intake	€/m³ intake	€/m³ intake
i=2%, r=0%	272'913'283	319'408'408	380'161'963	0,21	0,24	0,29
i=3%, r=0%	264'451'107	307'548'213	362'494'731	0,20	0,23	0,27
i=5%, r=0%	249'283'186	287'045'472	333'863'315	0,19	0,22	0,25
i=3%, r=2%	279'876'831	327'106'049	391'170'496	0,21	0,25	0,30
i=3%, r=3%	289'900'394	339'779'370	409'524'588	0,22	0,26	0,31
i=3%, r=5%	316'356'959	373'229'806	457'969'063	0,24	0,28	0,35

with i = discounting rate and r = inflation rate (on energy, operating supplies and personnel costs, and maintenance)

### 3.3.3.3 Summary of LCA/LCC results

A summary of LCA and LCC results is provided in Table 3-5 below.

**Improved drinking water quality, but underestimated by LCA:** Reported improvements in drinking water quality by dune infiltration, post-treatment and possible AOP pre-treatment relate to a reduction in emerging contaminant concentration and selected heavy metals (cf. Table 3-3) here. However, the latter aspect is only partially represented in this study, as only nine selected emerging contaminants are assessed and raw water contains only eight of those emerging contaminants in the lower ng/L range. Other emerging contaminants potentially contained in the source water from the Meuse River such as other pesticides and hormones are not accounted for in this LCA, because adequate characterization factors for their effect are currently lacking. Hence, the positive effect of dune infiltration and AOP on drinking water quality and potential benefits for human health is most probably underestimated in this LCA. On-going research will enhance the capacity of LCAs to better capture these emerging contaminants (also see DEMEAU report on the methodology: Remy et al. 2015). Concerning the geogenic transfer of As into the water during dune infiltration, Dunea is addressing this issue pro-actively with anticipating potentially lower drinking water standards in the future and planning for measures to mitigate relevant As concentration.

**Water transport has highest environmental and cost impacts in the current system:** Regarding impacts of construction and operation, LCA results show that dune infiltration with post-treatment requires  $5.8 \text{ MJ/m}^3$  and has a carbon footprint of  $0.43 \text{ kg CO}_2\text{-eq/m}^3$ . From these impacts, only a smaller proportion can be directly associated with the dune infiltration system itself and the required post-treatment, as most electricity is required for transport of water from the intake to the dune area (64% of total electricity demand). LCC states the impression of dune infiltration as a low energy and low chemicals demand process as only 9.4 % of the annual operational costs are caused by the infiltration and abstraction stage of the process. Nevertheless the initial investment, required for these parts of the system, is nearly equal the total investment for post treatment. As described above the electricity demand for transportation is clearly dominating the operational costs for dune filtration. For an energy- (and cost-)efficient drinking water production with low carbon footprint, transport of water should be reduced to a minimum by locating dune infiltration and post-treatment close to the water intake, but also to the final customers (water distribution is not included in this LCA).

**AOP processes - especially with UV - increase energy carbon footprint and costs due to high energy demand:** The addition of an AOP increases efforts for drinking water production significantly, adding up on energy demand (+23-74%) and respective carbon footprint (+23-64%). While the hydrogen peroxide process needs relatively low electricity and some chemicals, the implementation of a high-energy UV stage contributes to energy demand and carbon footprint due to a substantial increase in electricity demand (+97% of existing system). Considering that water treatment takes only a smaller share of the current electricity demand (36%) compared to water transport (64%), the effect of implementing an AOP on the total energy balance for water treatment is even more pronounced. Results of the life cycle costing support this impression: While dune filtration initially causes a NPV per  $\text{m}^3$  water intake of  $0.20 \text{ €/m}^3_{\text{intake}}$ , costs increase with ozonation up to 16–37%. A well thought-out design of the AOP process is therefore recommended to prove the absolute necessity of an UV stage (e.g. for reducing the formation of unwanted by-products such as bromate in the AOP) and optimize the additional energy demand for this step to a minimum. Related work has already been done within the DEMEAU project in improving the design of UV reactors and thus decreasing their specific energy demand.

Table 3-5: Summary of LCA and LCC results for Dunea case study

	MAR + post-treatment	O <sub>3</sub> /H <sub>2</sub> O <sub>2</sub> + MAR + post-treatment	O <sub>3</sub> /H <sub>2</sub> O <sub>2</sub> /UV + MAR + post-treatment
<b>Impacts on drinking water quality<sup>1</sup></b>			
Changes in human toxicity potential (non-cancer) [10 <sup>-9</sup> CTU <sub>h</sub> /m <sup>3</sup> ] <sup>2</sup>	-68.3	-68.3	-68.3
<b>Environmental impacts of construction and operation</b>			
Carbon footprint [g CO <sub>2</sub> -eq/m <sup>3</sup> ]	429	525	739
Energy demand (fossil) [MJ/m <sup>3</sup> ]	5.8	7.1	10.1
<b>Life Cycle Costs</b>			
Investment cost [€/ (m <sup>3</sup> <sub>intake</sub> /yr.)]	5.0	5.5	5.9
Operational cost [€/m <sup>3</sup> <sub>intake</sub> ]	0.06	0.08	0.11
Total life cycle cost [€/m <sup>3</sup> <sub>intake</sub> ] (i=3% and r=0%)	0.20	0.23	0.27

<sup>1</sup> only direct effects via consumption of drinking water, geogenic As excluded

<sup>2</sup> calculated with USEtox® characterization factors for 8 emerging contaminants (developed in DEMEAU WA5) and 7 heavy metals

### 3.3.4 Conclusions and Unique Selling Propositions

From the LCA and LCC assessment in this case study, the following unique selling propositions are found for MAR systems using dune infiltration for drinking water production combined with an AOP:

**USP1: Dune infiltration – a form of managed aquifer recharge - is a multi-functional barrier to contaminants with low energy and chemical needs**

Dune infiltration at Dunea serves as a barrier for multiple contaminants (chemical and microbial) and helps maintaining the freshwater lens under the dunes to assure sufficient water supply. Dune infiltration can thus help buffering variations in quantity and quality of the feed water, so that a continuous supply with good drinking water can be provided. Such a natural system thus fulfils many functions which would be very difficult and expensive to be replaced by technological systems. Geogenic alterations of water quality should be closely monitored to prevent potentially negative effects on consumers.

**USP2: AOP pre-treatment for dune infiltration based on ozone and hydrogen peroxide can mitigate potential risks from emerging contaminants taking also advantage of the biologically active zone in the dune aquifer to further degrade possible transformation products of the oxidation**

Upgrading the dune filtration system with an AOP upfront is a feasible process to eliminate potentially hazardous organic contaminants emerging in the source water. The subsequent underground passage removes oxidized substances and biologically available organic carbon, so that a stable drinking water can be produced. Careful optimisation of energy demand (especially for UV system) and minimisation of by-product formation has to be targeted, as AOPs can add significantly to existing energy demand and carbon footprint of drinking water production.

### 3.4 CS1.2: Pilot-scale additional organic reactive layer

#### 3.4.1 Case study description

The recharge system of Sant Vicenç dels Horts (SVH) is located in the vicinity of Barcelona in the Llobregat area, which is one of the pioneer zones in Spain in terms of MAR. In this area, several types of MAR have been historically implemented to improve the quality and the quantity of the groundwater: e.g. scarification of river beds, well injection, and infiltration in ponds (Hernandez Garcia et al. 2011). The system at SVH was built in 2007 and started operation in 2008/09, managed by the Catalan Water Agency (ACA). The pond system is designed to receive water from the Llobregat River or reused treated wastewater from the WWTP Baix Llobregat for artificial infiltration into the aquifer.

The system includes a decantation pond (4'000 m<sup>3</sup>) and an infiltration pond (5'600 m<sup>3</sup>) for pre-treatment of the infiltrating water. The infiltration rate reaches 1 m<sup>3</sup>/(m<sup>2</sup>\*d) on an infiltration area of 5'600 m<sup>2</sup> (see Figure 3-15). It is operated seasonally in periods when river water quality and quantity are sufficient for infiltration (140-170 d/yr.).

**Key figures:**

Infiltration surface:	5'600 m <sup>2</sup>
Design flow:	250 m <sup>3</sup> /h
Infiltration rate:	1 m <sup>3</sup> /(m <sup>2</sup> *d)
Operational flow:	200-500 m <sup>3</sup> /h
Recharged volume:	0.8-1.2 Mio m <sup>3</sup> /yr.



Figure 3-15: Aerial picture of groundwater recharge system at Sant Vicenç dels Horts

Experience shows that the processes which take place between the recharge water and the soil enhance the quality of the groundwater resources, e.g. denitrification for nitrogen removal or removal of organic matter which are both boosted by the microbial activity in the un-saturated zone. However, these processes require sufficient residence time and the presence of easily degradable organic carbon to facilitate the growth of micro-organisms. In this case, the river water has low content of dissolved organic carbon (DOC = 4 mg/L), providing non-optimum conditions for microbial growth.

To overcome this limitation in microbial activity and improve the capacity of the system to remove organic compounds and especially emerging contaminants, a reactive organic layer (60 cm of compost, mixed with local soil and adsorptive material such as clay and iron oxides) has been installed at the bottom of the infiltration basin in SVH (see Figure 3-16). This layer should promote the release of easily degradable organic carbon to enhance microbial activity and increase sorption processes to remove emerging contaminants from recharge water. This system has been installed during the EU project ENSAT (2010-2012, <http://www.life-ensat.eu>), and the related monitoring campaign showed an enhanced removal of selected organic emerging contaminants (carbamazepine-epoxy, gemfibrozil) and improved denitrification.

The relevant application area for pond systems with an organic layer are seen for groundwater recharge with enhanced emerging contaminant removal for aquifer replenishment in quality and quantity, to finally enhance available resources for production of drinking water or irrigation purposes.

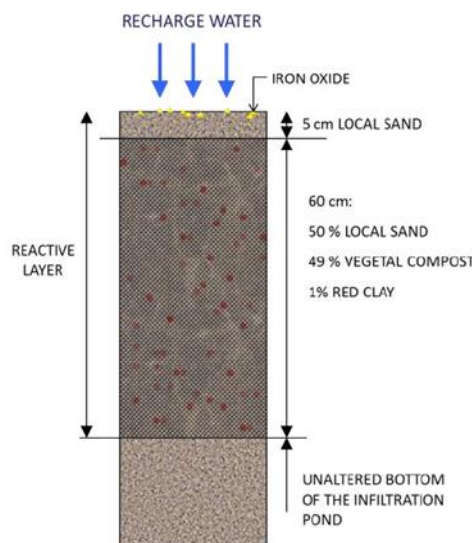

Figure 3-16: Proposed design for the reactive layer at MAR system at SVH

### 3.4.2 LCA and LCC: Definitions of goals and scope

#### 3.4.2.1 Definition of goals

The goals of LCA and LCC studies for the SVH system within DEMEAU are twofold: 1) compare different configurations of MAR in their environmental and economic impacts 2) reveal the unique selling point of pond systems in comparison to well injection for groundwater replenishment. The first goal is related to the interest of local stakeholders in comparing different management strategies for infiltration in their environmental and economic profiles under local conditions. The second goal is

more strategically oriented to the overall goals of DEMEAU by promoting innovative technologies such as MAR pond systems for water management, focusing on the issue of emerging pollutants.

### 3.4.2.2 Functional unit

The functional unit for the comparison is defined through the volume of infiltrated groundwater, i.e. “per m<sup>3</sup> of infiltrated groundwater”. Thus, water losses in the MAR systems due to evaporation can be taken into account. The minimum quality requirements of the infiltrated groundwater are defined by local regulations for groundwater recharge. Effective differences in infiltrated groundwater (e.g. concentrations of N, P, selected organic emerging contaminants) due to different treatment options (soil passage in MAR, pre-treatment before deep well injection) is reflected in the respective LCA indicators of marine and freshwater eutrophication and ecotoxicity.

### 3.4.2.3 System boundaries and investigated systems

The system boundaries include the entire treatment scheme from the source water (= river water) to the infiltrated groundwater (Figure 3-17). All processes and infrastructure of the different MAR systems are taken into account. The recovery of infiltrated water (e.g. for drinking water production, agricultural irrigation etc.) is excluded from the assessment. All investigated systems use the same feed water quality and infiltrate a specified amount into the groundwater aquifer.

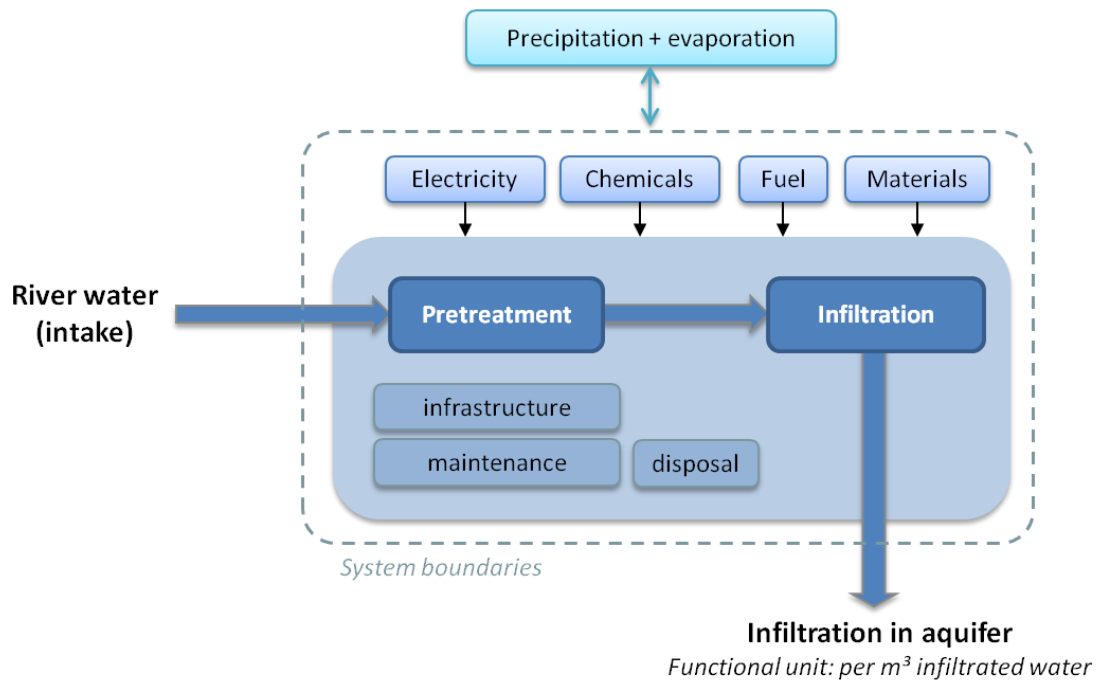

Figure 3-17: System boundaries of LCA/LCC study for MAR systems at SVH

In total, six different scenarios are analysed in this case study (Figure 3-18):

- S1 Pond infiltration (“status quo”):** this scenario describes the MAR system in its initial state at SVH. It includes the construction of the intake pipe and two ponds and the regular maintenance (topsoil removal for clogging prevention, and dumping on-site of the removed material). River water is delivered to the ponds by gravity through the inlet pipe (no pumping). Data is based on the actual construction data and performance of the system at SVH.
- S2 Pond infiltration with sand washing:** this scenario is based on scenario 1, adding a defined sand layer (0.9 m thickness) and dedicated washing process for regular maintenance to prevent clogging



of the upper layer of the pond. The sand layer can be cleaned on-site (extraction via pumping, washing, and refill) and reused in the pond. Data is based on design studies at SVH and other sites.

- S3 Pond infiltration with organic layer:** this scenario is based on scenario 1, adding an organic layer (0.6 m thickness) in the infiltration pond for improved removal of emerging contaminants. The removal data for emerging contaminants is based on results of the ENSAT project and related lab trials in ENSAT and DEMEAU (ENSAT 2012).
- S4 Scarification in riverbed:** this option is traditionally practiced since the 1960s in the area. It involves the scarification of the river bed in-situ by periodically operating specific machinery in the riverbed if river conditions (quantity, quality) are within suitable ranges. Thus, direct infiltration of the river water through the riverbed is promoted, even though the effective amount of infiltrated water is low due to riverbed sediments which quickly block the scarified area. Data is based on previous studies and experience of project partners and local stakeholders.
- S5 Scarification in constructed channel:** this option involves the construction of an artificial infiltration channel next to the riverbed. Starting with a dedicated inlet structure (fixed concrete channel), a small channel (2-3 m width) for infiltration is excavated in parallel to the river to infiltrate the water. Surface clogging is prevented by regular scarification of the surface with machinery. Lifetime of the channel is supposed to be limited due to underground clogging after a few years. The channel is equipped with an overflow outlet structure to the river if feed water cannot be adequately infiltrated in the channel. Data is based on planning of local DEMEAU partners.
- S6 Surface water treatment and well injection:** this scenario represents an alternative option for groundwater replenishment, referring to pre-treatment of river water and subsequent well injection directly into the aquifer. Pre-treatment consists of coagulation, flocculation and sedimentation, rapid sand filtration and disinfection. A comparable process has been operated near SVH in the past (Cornellà site), and the inventory data is adapted and transferred from this system to a hypothetical case at SVH.

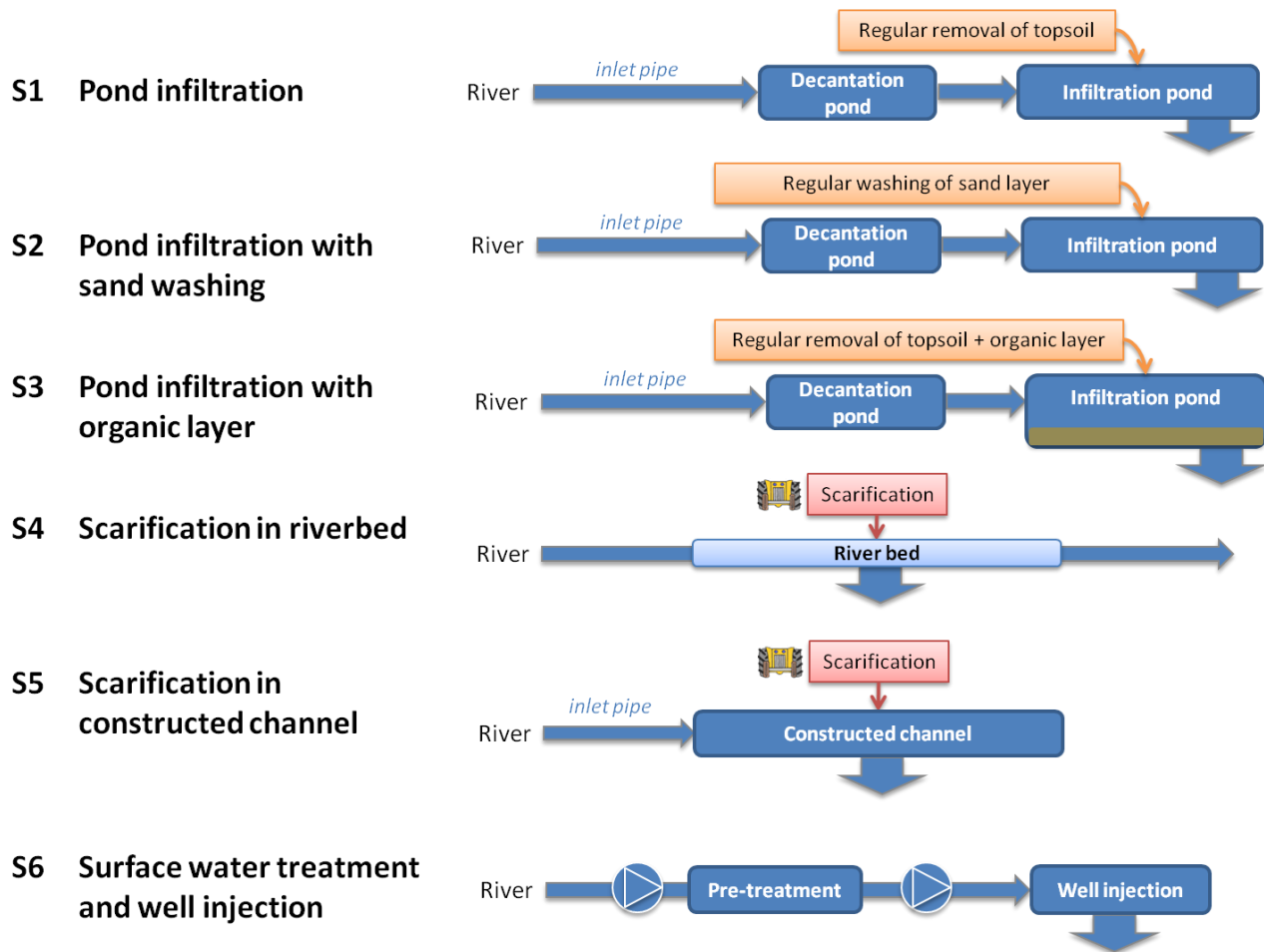

Figure 3-18: Scenarios for LCA and LCC of different MAR systems and reference at SVH

3.4.2.4 LCA and LCC inventory

Basic data on the infiltrated volumes of water is provided from local partners, based on existing facilities or planning data (Table 3-6). Mean annual operation times show that the recharge systems are operated only when suitable conditions in quality and quantity are reached in the river. These conditions have been defined by local authorities to prevent negative impacts of groundwater recharge on both groundwater quality and minimum river flow. Whereas infiltration rates of the pond systems (scenarios 1-3) are determined by inflow measurements at the infiltration ponds (mean infiltration rate of  $0.85 \text{ m}^3/(\text{m}^2 \cdot \text{d})$ ), actual infiltration rate in riverbed scarification is difficult to measure. Conservative estimates of local partners for riverbed infiltration amount to  $0.1 \text{ m}^3/(\text{m}^2 \cdot \text{d})$  based on different measurement techniques. Infiltration rate in channel was estimated based on previous experience with infiltration systems. Min-max ranges of infiltration rates were based on previous experience of DEMEAU partners. Infiltration area relates to the existing or planned activities in the SVH area. For the hypothetical injection system (S6), an annual infiltration volume ( $3.0 \text{ Mio m}^3/\text{yr.}$ ) was assumed to define a system with comparable hydraulic capacity.

For direct water footprint of the systems, the local evaporation rate of  $1'075 \text{ mm/yr.}$  was used to calculate water losses by evaporation due to water storage in pond, taking into account only the days of system operation and the surface area of the ponds. Water stress index (WSI) of the local area in SVH is estimated at 0.996 (Pfister et al. 2009), whereas WSI for background processes was assumed

with Spain average (0.715) for electricity production and European average (0.31) for all other background processes. For indirect water consumption, data from Quantis Water database was used (Quantis 2011).

Inventory data for operation and infrastructure of the systems was provided by local partners CETaqua and ACA/CUADLL. Operational data of the systems include electricity and chemicals demand and operation of machinery (fuel consumption) as listed in Annex-B. Water quality data for river water and infiltrated groundwater is based on monitoring of river quality and dedicated monitoring of the MAR system. Removal rates for organic emerging contaminants were adopted from soil column experiments with local soil material (ENSAT 2012), also including additional effects of the organic layer. For simplification, scarification systems were estimated to be comparable to pond infiltration (without organic layer) in their effect on river water quality.

Table 3-6: Operational data of the different systems analysed in LCA

		Pond system (S1, 2, 3)	Scarification in river bed (S4)	Scarification in channel (S5)	Well injection (S6)
<b>Infiltration area</b>	m <sup>2</sup>	5'600	20'000	23'200	-
<b>Operation time</b>	d/yr.	250	50	250	250
<b>Infiltration rate (min-max)</b>	m <sup>3</sup> /(m <sup>2</sup> *d)	0.85 (0.5-1.2)	0.1	0.64 (0.25-1)	-
<b>Infiltration volume (min-max)</b>	Mio m <sup>3</sup> /yr.	1.2 (0.7-1.7)	0.1	3.7 (1.7-10.4)	3.0

For the baseline scenario, the inventory includes the construction of the inlet pipe (2'000 m, reinforced concrete, DN1500) and ponds (8 m depth). Upstream of the infiltration pond (5'600 m<sup>2</sup>), a sedimentation pond was constructed to eliminate particulate matter (4'000 m<sup>2</sup>). The technical lifetime of the pond system (ponds and pipes) was assumed to 50 years with proper maintenance. The biannual maintenance is the removal of the topsoil layer (15 cm) which is disposed near the site.

Scenario 2 includes a dedicated sand layer (90 cm, 5040 m<sup>3</sup>), annual washing of the removed sand on-site (electricity demand for washing machinery) and refill of the cleaned sand in the pond again.

In scenario 3, the organic layer is replaced after 5 years and disposed in agriculture nearby (20 km truck transport). Compost of organic layer is seen as waste product without impacts, as impacts of composting are allocated to the upstream origin of the waste. Potential impacts of accumulated emerging contaminants in the compost layer on soil quality were neglected in this LCA.

For the scarification in riverbed in scenario 4, only the operation of the scarification machinery was accounted in relation to the frequency of scarification and the scarified area.

For the scarification in the constructed channel in scenario 5, an inlet and outlet concrete channel was constructed (length 50 m, 2 m x 1 m) which connects to the excavated channel (1 m depth, only excavation). Due to expected clogging issues, the lifetime of this channel was assumed to 3 years only, after which a new channel has to be excavated.

The system for surface water treatment and well injection (S6) consists of an inlet pump, followed by coagulation, flocculation and sedimentation (Densadeg system), rapid sand filters and disinfection.

Pre-treated water is then pumped to four injection wells (capacity 3'000 m<sup>3</sup>/d each) and injected into the aquifer. Operational data is adopted from Cornellà pre-treatment system (0.039 kWh/m<sup>3</sup>, 3.6 mg/L Al, 2.8 mg/L NaClO<sub>2</sub>, 1.2 mg/L Cl<sub>2</sub>) and the corresponding well injection system against seawater intrusion (0.034 kWh/m<sup>3</sup>). Construction materials for the injection system were roughly estimated based on previous studies, with lifetime of 30 years for civil works and 40 years for wells.

Construction material concrete is disposed after lifetime (30 km truck transport). Water quality data for the source water (= river Llobregat) was adopted from long-term monitoring. Water quality of infiltrated water was estimated from on-site sampling campaigns (e.g. ENSAT) in attenuation zone and simulation of infiltration in soil column experiments with local material or organic layer (Table 3-7). For the injection system, data of Cornellà site was adopted. Background datasets were extracted fromecoinvent database v2.2 (Table B-2). Scarification machinery was estimated with tillage dataset and recalculated through working time (8 h/d). Cost data for the different scenarios was compiled in cooperation with local partners (Cetaqua) and validated with MAR system operators (CUADLL) (Table B-3). For the injection system, investment costs were adopted from Cornellà system for pre-treatment and well costs. Lifetime of investment was estimated for pipes/ponds/land area (18 years), organic layer (5 years), piezometers (40 years), instrumentation (25 years), scarification channel (3 years), pre-treatment system (civil works: 20 years, machinery: 15 years, electrical: 10 years) and wells (40 years).

Table 3-7: Water quality data of the different scenarios in SVH

Parameters		River water	Infiltrated water of ponds or scarification (S1, S2, S4, S5)	Infiltrated water of pond with organic layer (S3)	Infiltrated water of well injection (S6)
<b>Bulk parameters</b>					
Suspended solids	[mg/L]	42	5	5	5
Total nitrogen (inorganic)	[mg/L]	2	1	1.6	1.6
Total phosphorus	[mg/L]	0.19	0.07	0.07	0.04
<b>Organic emerging contaminants</b>					
1H-Benzotriazole	[ng/L]	<LOQ			
Bezafibrate	[ng/L]	<LOQ			
Carbamazepine	[ng/L]	25	25	22	25
Diclofenac	[ng/L]	<LOQ			
Iopromide	[ng/L]	<LOQ			
Metoprolol	[ng/L]	<LOQ			
Phenazone	[ng/L]	<LOQ			
Sulfamethoxazole	[ng/L]	54	54	4	54
Trimethoprim	[ng/L]	<LOQ			
<b>Microbiological parameters</b>					
E. coli	[CFU/100mL]	10 <sup>2</sup> -10 <sup>4</sup>	1	1	10 <sup>4</sup>

Parameters		River water	Infiltrated water of ponds or scarification (S1, S2, S4, S5)	Infiltrated water of pond with organic layer (S3)	Infiltrated water of well injection (S6)
Enterococci	[CFU/100mL]	10 <sup>2</sup> -10 <sup>3</sup>	0	0	10 <sup>2</sup>
Total coliforms	[CFU/100mL]	10 <sup>3</sup> -10 <sup>6</sup>	0	0	10 <sup>3</sup> -10 <sup>4</sup>
Clostridium perfringens	[CFU/100mL]	10 <sup>3</sup> -10 <sup>4</sup>	0	0	10 <sup>2</sup>

CFU = colony forming units, LOQ = limit of quantification

### 3.4.3 Results and discussion

#### 3.4.3.1 LCA impact assessment

For impact assessment in LCA, a defined set of eleven indicators was used to assess the potential environmental impacts and benefits of the six different scenarios. While eight indicators were chosen from the LCIA model ReCiPe (Goedkoop et al. 2009), two indicators reflecting cumulative energy demand of fossil and nuclear fuels are adopted from VDI 4600 (VDI 2012).

In addition to this defined set of indicators, DEMEAU also evaluated direct and indirect impacts of these technologies on overall water consumption in the life cycle, following the newly developed concept of water scarcity footprint (for definition see Remy et al. 2015). As this indicator is still under development, its calculation can be regarded as a test run to explore the relevance of this indicator for evaluating dedicated processes for water treatment and their overall impact on the water cycle.

#### Total environmental impacts and benefits of all scenarios

The environmental profiles of all scenarios for the set of eleven indicators are shown relative to the scenario with min/max impacts (= 100%) of each respective indicator (Figure 3-19). This reveals that pond systems (S1-3) require a significantly lower effort in treatment than both riverbed scarification (S4) and surface water treatment + well injection (S6) (Figure 3-19). Both scenarios S4 and S6 are characterized by higher impacts in the operational stage, showing up in terms of energy demand in fossil and nuclear fuels and also in related emissions causing a higher global warming potential (GWP), terrestrial acidification potential (TAP), particulate matter formation (PMF), and human toxicity (HTP). In contrast, pond scenarios have a low energy demand and related low indirect emissions from background processes. For water-quality related indicators freshwater eutrophication potential (FEP) and marine eutrophication potential (MEP), all scenarios can reduce the potential environmental impacts by removing some nitrogen and phosphorus from the source water. Water scarcity footprinting shows that pond systems have a higher water scarcity footprint (WSCF) due to on-going evaporation of water during open pond infiltration, contributing to a direct “water loss” on-site.

Taking a closer look at the comparison between the pond scenarios (S1-3), the environmental indicators show that layer management strategies for ponds (S2, S3) can also increase energy demand and related emissions of pond infiltration considerably. While the impacts of the simple pond system (S1) are dominated by infrastructure, the introduction of a sand layer (S2) and its regular washing increase energy demand and related emissions by a factor two to five. In contrast, the introduction of the organic layer for improved removal of emerging contaminants adds only smaller additional impact for infrastructure.

Overall, the total environmental profiles show that pond systems are superior in their environmental profile towards traditional riverbed scarification (S4) and surface water treatment + well injection (S6). However, dedicated clogging management for the pond operation can increase its environmental impact due to higher efforts in operation. In the following chapters, selected indicators for energy demand, related emissions and water quality are analysed in detail to identify major contributions for environmental impacts in relation to the characteristics of the different treatment processes.

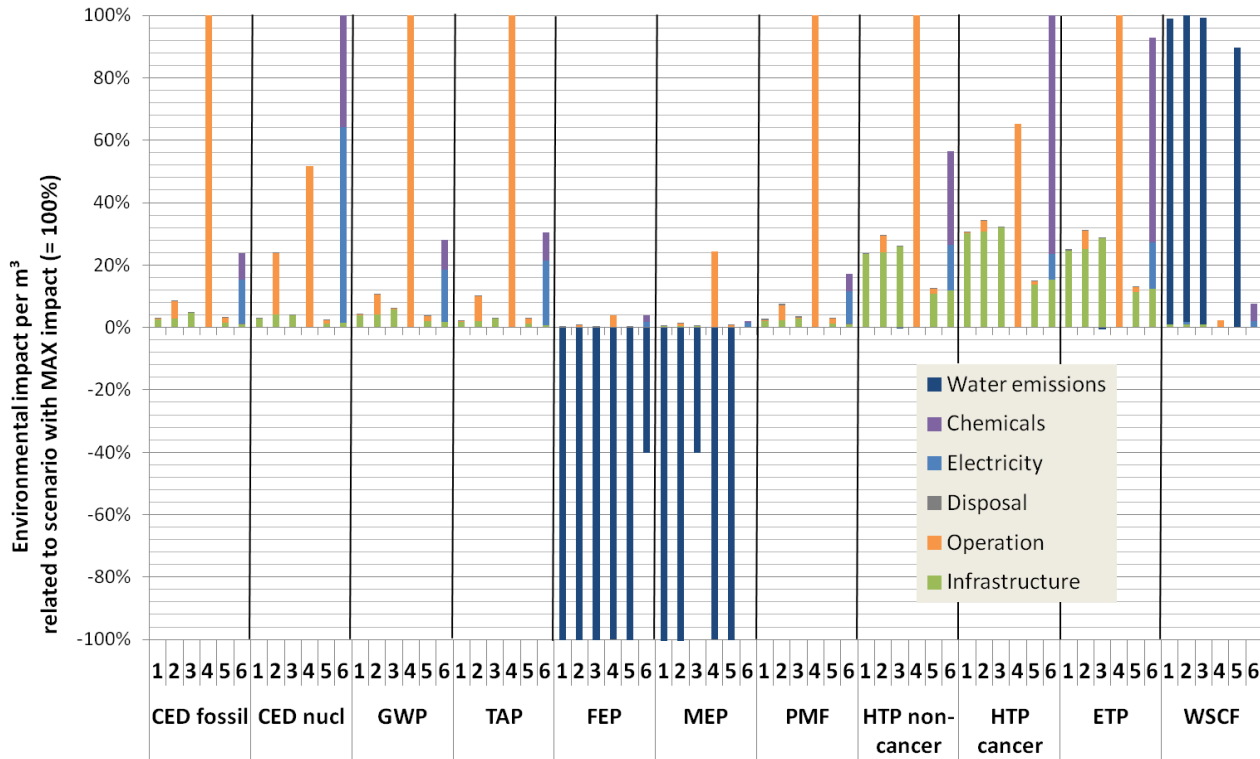

Figure 3-19: Environmental profiles of six scenarios for groundwater recharge at SVH

(1: Pond infiltration, 2: Pond infiltration + sand washing, 3: Pond infiltration + organic layer, 4: riverbed scarification, 5: scarification in channel, 6: surface water treatment + well injection) related to the scenario with MAX or MIN impacts (= 100%) for each respective indicator (CED: cumulative energy demand, GWP: global warming potential, TAP: Terrestrial acidification potential, FEP: Freshwater eutrophication potential, MEP: Marine eutrophication potential, PMF: Particulate matter formation potential, HTP: Human toxicity potential, ETP: Ecotoxicity potential, WSCF: Water scarcity footprint)

**Effect of construction and operation of system (“indirect effects”)**

Indirect effects of groundwater infiltration systems on the environment are caused by materials and machinery for constructing the infrastructure, but also from operational efforts in terms of machinery (e.g. for scarification), electricity, and chemicals demand. These effects take place in the supply chain for production and transport of fuels, materials, chemicals, and infrastructure, but also on-site during fuel combustion in machinery.

Analysing the CED<sub>fossil</sub> of the different scenarios (Figure 3-20), it is obvious that pond infiltration itself is a low-energy process, with only 0.1 MJ/m<sup>3</sup> infiltrated water. This low energy demand is due to its long-lasting infrastructure and simple mode of construction (excavation of pond, concrete pipes), together with almost negligible efforts in operation (no pumping or chemicals required). Adding a dedicated strategy for clogging prevention (sand layer and regular washing) increases the energy demand to 0.3 MJ/m<sup>3</sup>, which is still well below the technical system with treatment and injection (0.8 MJ/m<sup>3</sup>). The construction of the organic layer (S3) does not significantly affect the overall energy

demand. In contrast, riverbed scarification (S4) is characterized by the highest energy demand (3.3 MJ/m<sup>3</sup>), even though this process only involves operation of scarification machinery, without any investment in infrastructure. However, the low infiltration rate realized in this scenario (yielding only 0.1 Mm<sup>3</sup>/yr.) results in a high relative energy demand for groundwater recharge.

The constructed channel (S5) is a low-energy alternative for MAR, with an overall energy demand comparable to the simple pond system. If the channel can be operated with stable infiltration rates by regular scarification, this system can realize an efficient infiltration with low energy demand and is superior to the pond system with sand washing in energy efficiency.

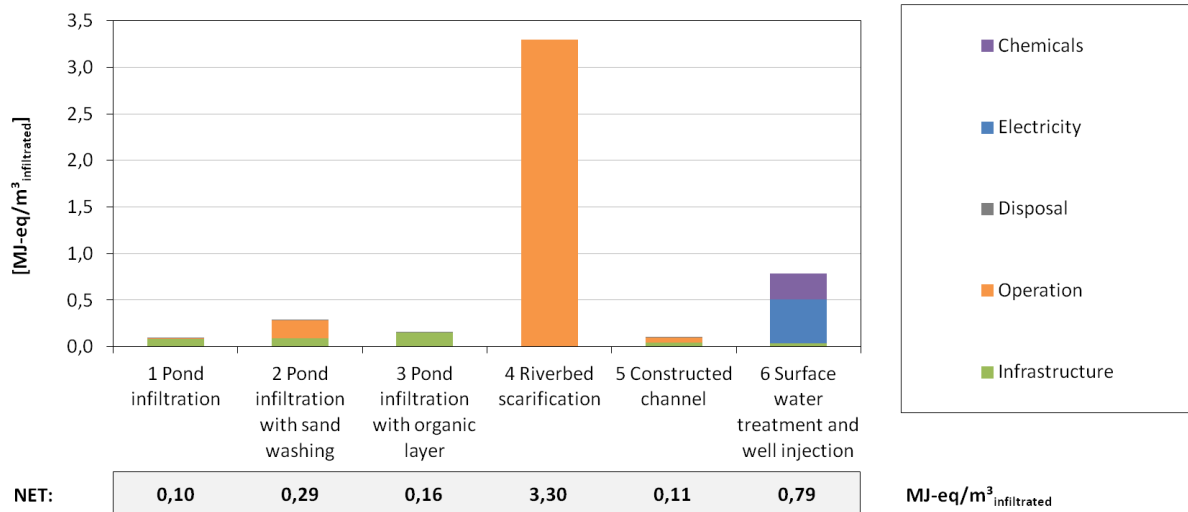

Figure 3-20: Cumulative energy demand (fossil) of groundwater recharge scenarios in SVH

As expected, GWP impacts correlate closely with the demand for fossil fuels, confirming that indirect effects dominate this environmental impact category. Again, the simple pond system (S1) and constructed channel (S5) have the lowest GWP with 9-10 g CO<sub>2</sub>-eq/m<sup>3</sup>, followed by the pond with organic layer (14 g CO<sub>2</sub>-eq/m<sup>3</sup>) or sand washing (25 g CO<sub>2</sub>-eq/m<sup>3</sup>). Due to its high demand for electricity and chemicals, surface water treatment + well injection cause higher GWP (64 g CO<sub>2</sub>-eq/m<sup>3</sup>). With very low infiltration rates, riverbed scarification is characterized by the highest GWP of all scenarios (228 g CO<sub>2</sub>-eq/m<sup>3</sup>).

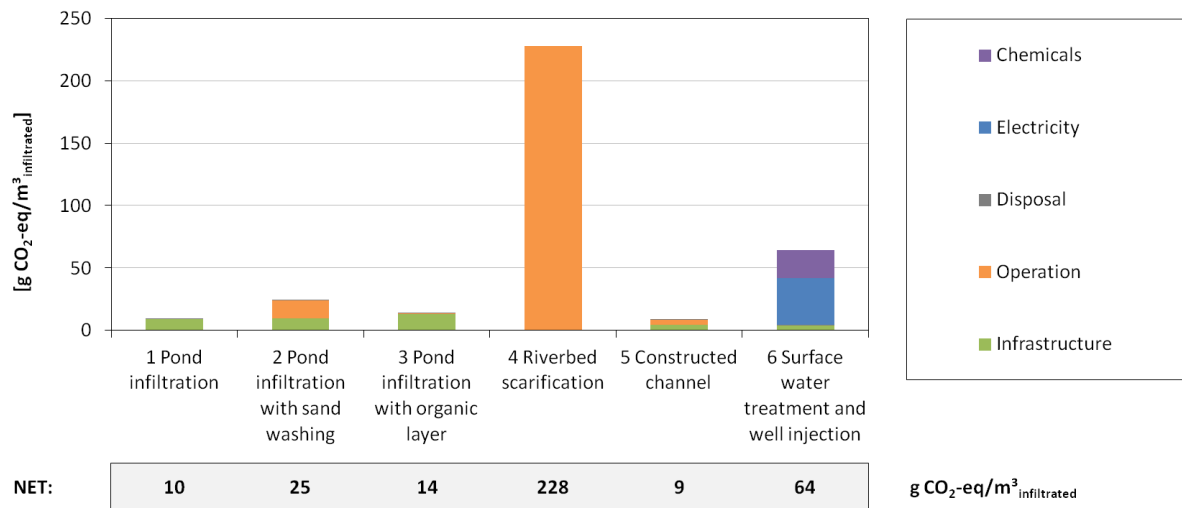

Figure 3-21: Global warming potential (100 years) of groundwater recharge scenarios in SVH

**Effects on water quality (“direct effects”)**

Groundwater recharge systems also have direct effects on the local environment by eliminating both nutrients and emerging contaminants from source water through bio-degradation and sorption processes. Groundwater recharge by infiltration and soil passage removes some particulate phosphorus from river water, reducing overall FEP by 110-115 mg P-eq/m<sup>3</sup> in the SVH system (Figure 3-22). For injection systems, physical pre-treatment via sand filtration is estimated to remove less particulate matter, resulting in a lower benefit in FEP (42 mg P-eq/m<sup>3</sup>). Indirect emissions of P in background processes are negligible for the overall assessment.

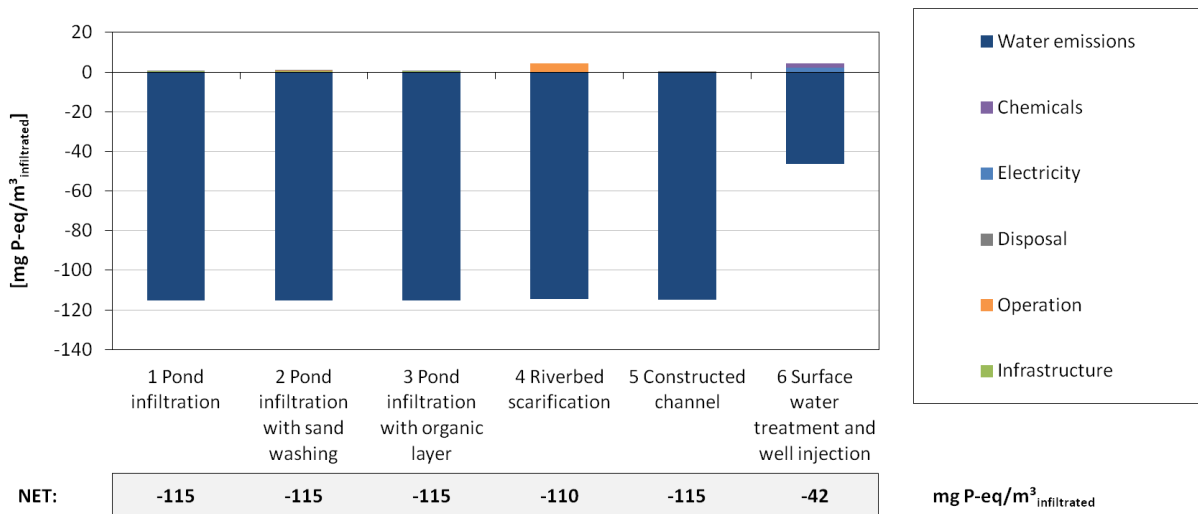

Figure 3-22: Freshwater eutrophication (P) of groundwater recharge scenarios in SVH

Similar effects can be observed for nitrogen causing marine eutrophication. Due to the passage of an unsaturated zone, biological activity of nitrification and denitrification will remove some nitrogen from the source water in scenarios S1-5, reducing MEP by 1.4-3.5 g N-eq/m<sup>3</sup> (Figure 3-23). The introduction of the organic layer leads to rapid oxygen consumption in the top soil layer, thus decreasing the nitrification capacity of the pond system in S3. For the technical treatment system (S6), no nitrification or denitrification is expected. Again, the indirect effects on MEP are relatively low,



even though the operation of machinery can introduce some indirect effects of nitrogen-gas emissions (NO<sub>x</sub>) for scenarios S2 and S4.

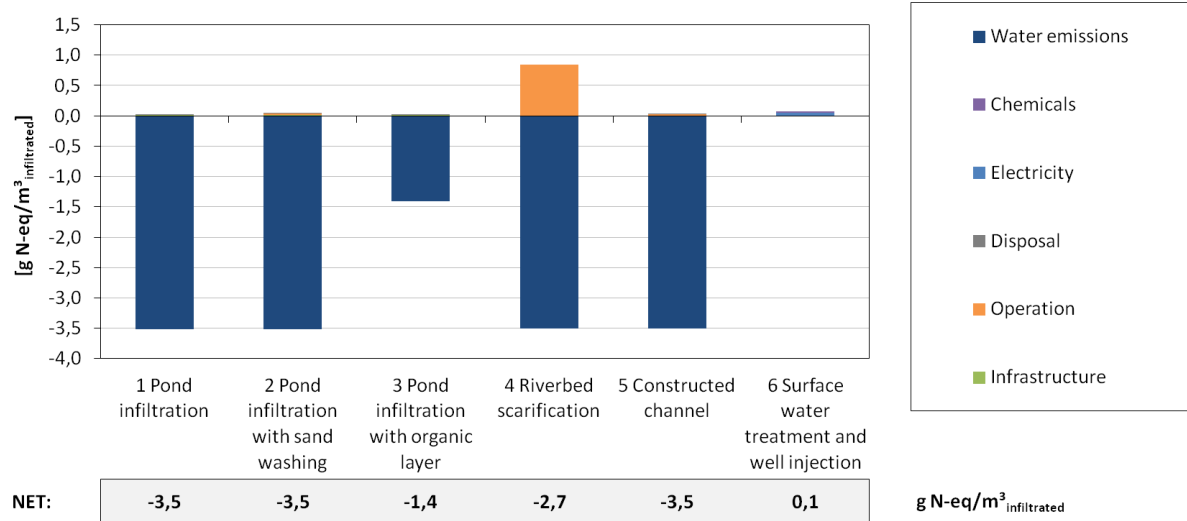

Figure 3-23: Marine eutrophication (N) of groundwater recharge scenarios in SVH

For ecotoxicity assessment, indirect effects from background processes of construction and operation dominate this impact category (Figure 3-24). For infrastructure, supply-chain emissions during concrete production for piping (S1-3, 5) or treatment facilities (S6) have a high impact in this category. For riverbed scarification (S4), operation of the machinery and respective fuel consumption contribute most to this category. Chemicals production of sodium chlorite and PACl are also characterized by relatively high emissions causing potential ecotoxicity in freshwater systems.

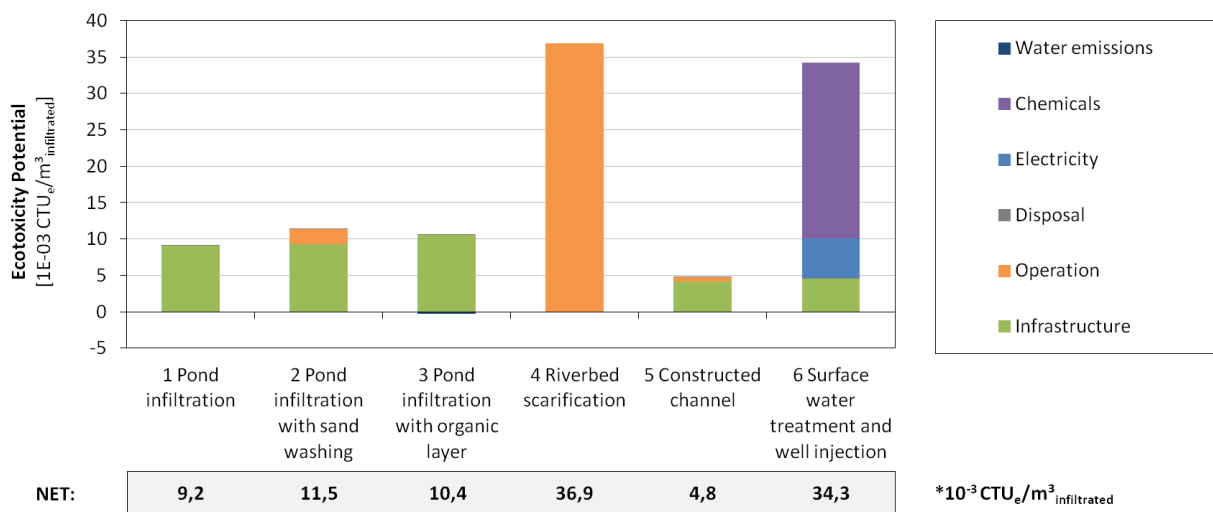

Figure 3-24: Ecotoxicity (freshwater) of groundwater recharge scenarios in SVH

Although direct impacts of emerging contaminant removal are partially included in this assessment (accounting for nine selected emerging contaminants with newly developed characterization factors), removal of emerging contaminants from river water results in a relatively small decrease of the global ecotoxicity potential, because emerging contaminants concentration is very low in the original river water (7 emerging contaminants assessed here are already below limit of quantification, 2 emerging contaminants are < 100 ng/L (Table 3-7)). Hence, the positive effect of emerging contaminants

removal is outweighed in the global analysis by indirect effects on water quality due to production of materials, fuels, electricity and chemicals. Nevertheless, scenario S3 with dedicated organic layer for improved elimination of emerging contaminants has the highest benefit in direct water emissions. In sensitivity analysis, the potential use of tertiary WWTP effluent with higher emerging contaminants concentrations is assessed as potential feed source for this MAR system to investigate the impact of using lower water quality on the ecotoxicity assessment.

For human toxicity (non-cancer), the situation is comparable to ecotoxicity assessment (Figure 3-25). The improvement by emerging contaminants removal of groundwater recharge systems is even more marginal, as characterization factors for emerging contaminants towards negative effects on human health are smaller than ecotoxicity factors. This impact category is dominated by indirect effects in the background processes, so that local benefits of improved water quality are outweighed by “supply-chain” impacts on a global level.

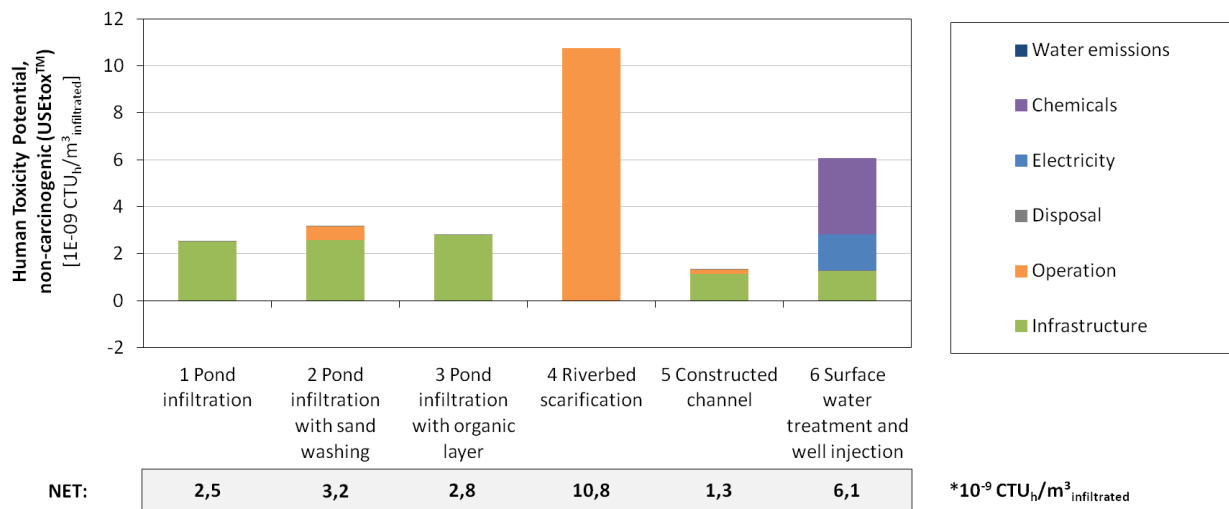

Figure 3-25: Human toxicity (non-cancer) for groundwater recharge scenarios in SVH

Concerning the water scarcity footprint, pond scenarios S1-3 have a higher impact on water resources due to the evaporation of water from the pond surface and the high water scarcity factor in the SVH area (Figure 3-26). Background processes such as electricity production or materials supply have only marginal impacts based on water inventories and lower water stress in assumed production locations (Spanish or European average). However, the impact on water scarcity footprint of pond systems can still be described as low in relation to the total infiltrated volume, with only  $0.006 \text{ m}^3\text{-eq}/\text{m}^3$  on average (= less than 1% losses). Overall, these preliminary results for water scarcity footprint have to be validated in the future with more precise data for water inventories of background processes and localized WSI factors depending on the area of production (e.g. electricity, materials, chemicals).

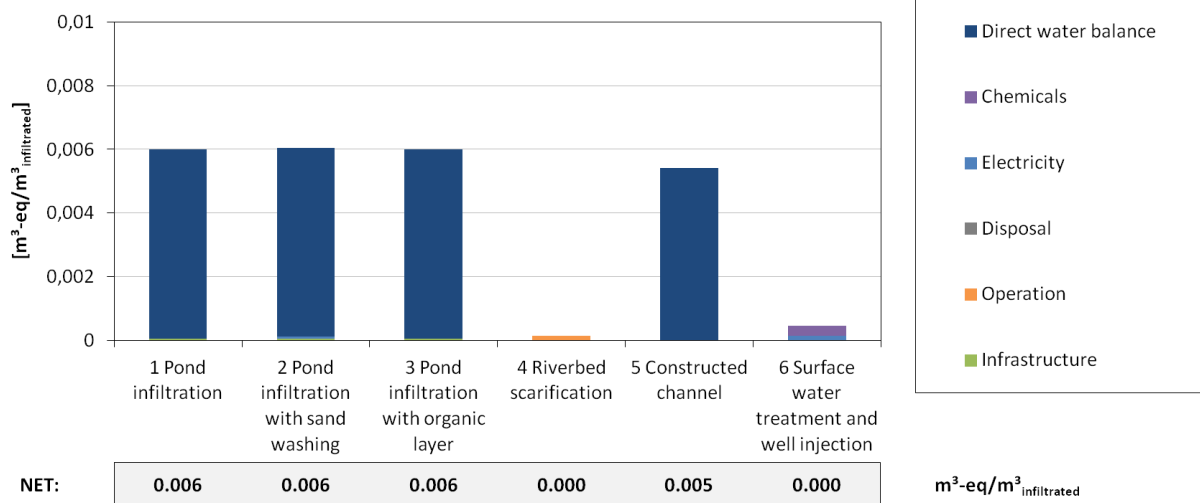

Figure 3-26: Water scarcity footprint of groundwater recharge scenarios in SVH (note that 0.01  $m^3\text{-eq}$  relate to 1% water loss in the systems compared to the produced volume)

**Sensitivity analysis: variation in infiltration rates**

In sensitivity analysis, the influence of changing infiltration rates of pond and channel infiltration systems on the impact category GWP is analysed as proxy for indirect effects. Infiltration rates in pond systems can be heavily affected by clogging (both in topsoil, but also deep clogging of infiltration layer) over time, so that long-term infiltration rates are difficult to maintain on a stable and high level. Hence, this case study includes a scenario with dedicated strategy for clogging prevention (S2 with sand layer and regular washing) as well as a simplified infiltration system in a channel (S5), which may be reconstructed with lower efforts in case of heavy clogging after few years of operation.

Sensitivity analysis using estimated min and max ranges of infiltration rates for scenarios S1-3 and S5 (as defined in Table 3-6) shows that the relative ranking of these scenarios in comparison to S4 and S6 is not affected by changing infiltration rates. However, a linear increase or decrease of GWP can be observed with realized infiltration volume. In the worst case, GWP of pond systems will be increased by 70% if infiltration rates fall to an expected minimum of  $0.25\ m^3/(m^2*d)$ . Low infiltration rates are more likely for scenarios 1 and 3 without clogging prevention, whereas sand washing strategy (S2) should stabilize infiltration rates on the long term. For riverbed scarification (S4), min/max infiltration rates are difficult to define, as real infiltration volumes cannot be quantified reliably. If this process can reach higher infiltration rates than expected ( $\gg 0.1\ m^3/(m^2*d)$ ), its GWP will decrease linearly and eventually become “competitive” with pond systems. For direct well injection, the infiltration rate is expected to maintain at a stable level without major sensitivity towards operational strategies.

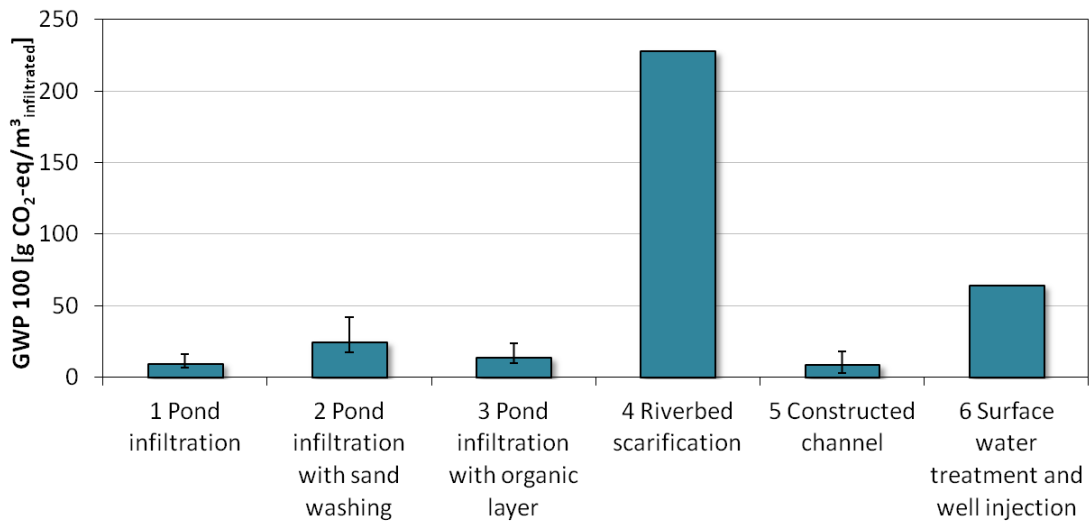

Figure 3-27: Sensitivity of global warming potential with min-max infiltration rates

**Sensitivity analysis: using tertiary WWTP effluent as feed water**

Another potential source for feed water to the MAR systems could be the effluent of the nearby WWTP “El Prat de Llobregat”, treating the wastewater of the Barcelona area. This tertiary effluent has higher concentrations of emerging contaminants and was used for soil column experiments to simulate MAR performance (Schaffer et al 2015). If this water is used as feed water for MAR, the ecotoxicity improvement due to emerging contaminants removal in the MAR systems is more visible in the LCA assessment (Figure 3-28). However, indirect impacts on ecotoxicity on a global scale (due to infrastructure, operation, etc.) still dominate this indicator category, so that the benefits of local water quality improvement come at the sake of higher ecotoxicity scores at the global level. Overall, this LCA does only assess nine selected emerging contaminants in their ecotoxicity effects. Tertiary WWTP effluent contains more than these emerging contaminants, and MAR will presumably remove some of them. An extrapolation method to estimate the total effect of water quality improvement by including unknown emerging contaminants in LCA is presented below in chapter 4.3.3.

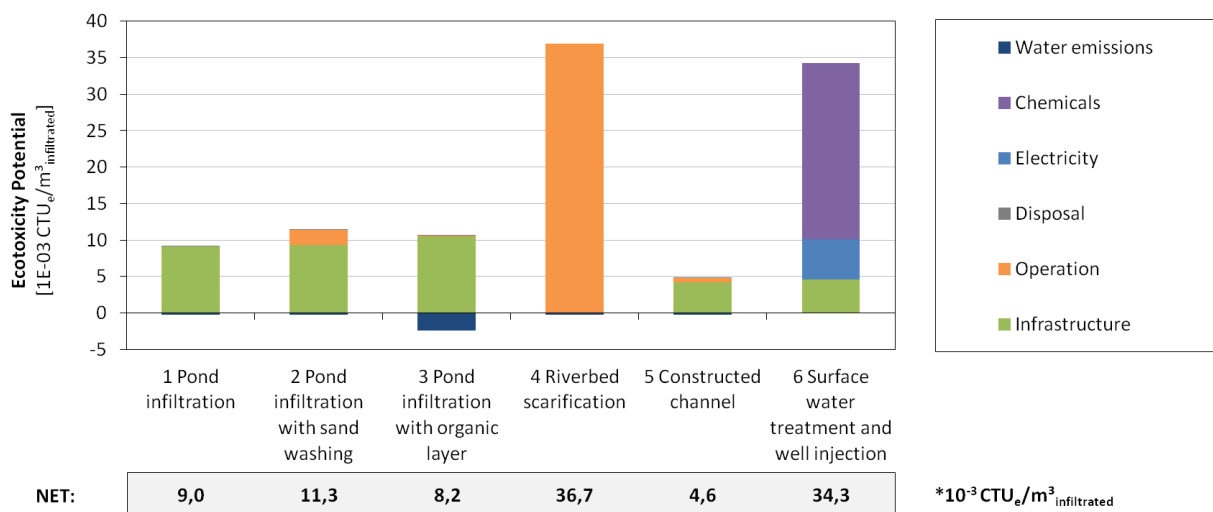

Figure 3-28: Sensitivity of ecotoxicity using tertiary WWTP effluent as feed water for infiltration

### 3.4.3.2 LCC assessment

To account for the costs of infiltrating water by managed aquifer recharge and well injection, capital expenditure (CAPEX) and operational expenditure (OPEX) of the six different MAR systems were collected. Each of the sums (CAPEX, OPEX) was aggregated and will now be presented as an absolute sum or in reference to the (annual) volume of infiltrated groundwater [EUR/m<sup>3</sup><sub>infiltrated</sub> or EUR/(m<sup>3</sup><sub>infiltrated</sub>/yr.)].

#### Capital costs for infrastructure

Capital expenditures (including all construction costs) for the three pond infiltration scenarios are dominated by the expenditure on ponds and pipes whereas the surface water treatment option is characterized by high costs for the pre-treatment facilities and wells. CAPEX for the three typical versions of pond infiltration are about 1.59-1.63 Mio. EUR. In comparison, riverbed scarification (S4) and scarification in a constructed channel (S5) appear to be much cheaper (0.06-0.19 Mio. EUR). But surface water treatment and well injection (S6) cause the highest initial capital expenditure by far (4.82 Mio. EUR).

If the capital expenditure is calculated in relation to the system’s capacity (Figure 3-29), this picture slightly changes. As in S6 the annual volume of infiltrated groundwater is nearly thrice as much as for pond infiltration, the relative costs per m<sup>3</sup> infiltrated water and year for this scenario (1.61 EUR/(m<sup>3</sup><sub>infiltrated</sub>/yr.)) are closer to those of S1-3 (1.34-1.36 EUR/(m<sup>3</sup><sub>infiltrated</sub>/yr.)). Nevertheless, CAPEX for scarification in riverbed (0.55 EUR/(m<sup>3</sup><sub>infiltrated</sub>/yr.)) or a constructed channel (0.05 EUR/(m<sup>3</sup><sub>infiltrated</sub>/yr.)) remain the lowest.

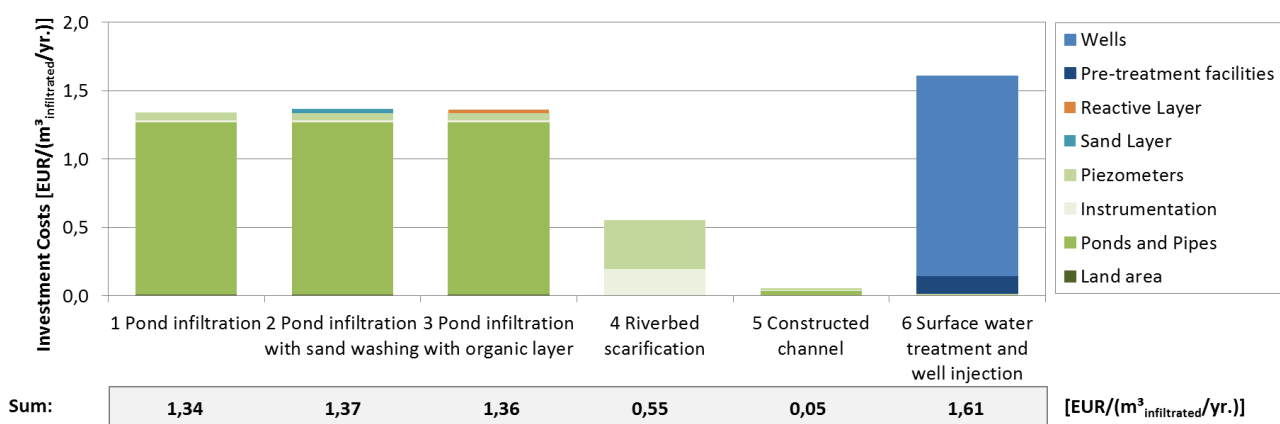

Figure 3-29: CAPEX per system capacity for groundwater recharge scenarios in SVH

#### Operational costs

For MAR systems operational expenditure can be caused by renting of machinery (e. g. for scarification), electricity and chemicals, as well as by personnel, analytics or monitoring and control.

Having an overall view at the operational expenditure of the different MAR scenarios (Figure 3-30), the results per m<sup>3</sup> infiltrated water indicate that the influence of layer management strategies (S2, S3) on the annual OPEX is very low. This states the impression described above that MAR technology is a low-energy process. Introducing a sand layer and its regular washing, for example, only rises the operating costs by 0.9 EUR-Ct/m<sup>3</sup><sub>infiltrated</sub> and the introduction of the organic layer causes additionally 1.5 EUR-Ct/m<sup>3</sup><sub>infiltrated</sub> because of the little increase in the overall energy demand. Costs of the conventional treatment plus well injection are on the same scale (0.06 EUR/m<sup>3</sup><sub>infiltrated</sub>) whereas, in

contrast, riverbed scarification induces nearly ten times higher specific operational costs than the other MAR systems (0.58 EUR/m<sup>3</sup><sub>infiltrated</sub>) due to the very high costs of the scarification process and a comparably very low annual infiltration rate (100'000 m<sup>3</sup>/yr.). As the infiltration rate for S5 is assumed to be about 3,700,000 m<sup>3</sup>, this MAR system appears to have the lowest specific operational costs of all MAR systems considered (0.02 EUR/m<sup>3</sup><sub>infiltrated</sub>).

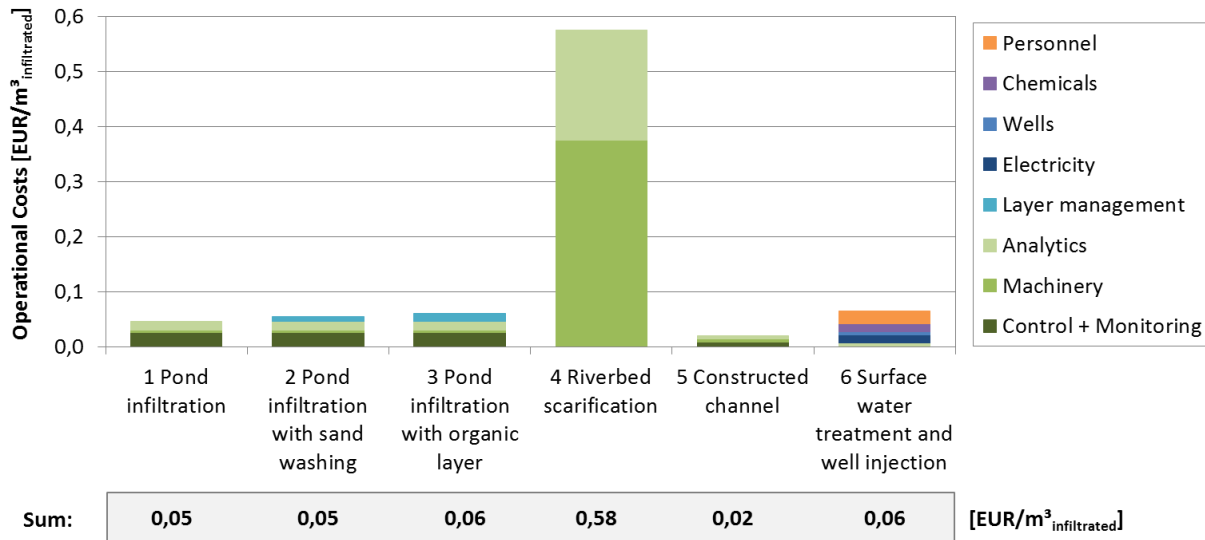

Figure 3-30: OPEX per m<sup>3</sup> infiltrated water for groundwater recharge scenarios in SVH

### Net present value over the life cycle

Overall the net present values over a system’s life cycle of 18 years prove that scarification in riverbed (S4) is the cheapest MAR technique (0.88 Mio. EUR) of the studied scenarios, followed by pond infiltration (S1-3) (2.33-2.45 Mio. EUR) and scarification in a constructed channel (S5) (1.70 Mio. EUR) (Figure 3-31). Due to its high investment, surface water treatment and well injection causes the highest NPV by far (7.86 Mio. EUR) while at the same providing the longest system lifetime. Therefore the amortization of investment can only be reached on a longer time horizon.

But with regard to its low infiltration rate, relative costs per m<sup>3</sup> infiltrated water (Figure 3-32) for riverbed scarification (0.49 EUR/m<sup>3</sup><sub>infiltrated</sub>) are much higher than those necessary for establishing a constructed channel (0.03 EUR/m<sup>3</sup><sub>infiltrated</sub>). If this channel can be operated with stable infiltration rates by regular scarification, this system is superior to all other MAR systems and can be realized for only 3 EUR-Ct/m<sup>3</sup>. Within these considerations, pond infiltration systems, inducing 0.11 EUR/m<sup>3</sup><sub>infiltrated</sub>, can be a competing technology to surface water treatment and well injection (0.15 EUR/m<sup>3</sup><sub>infiltrated</sub>), too.

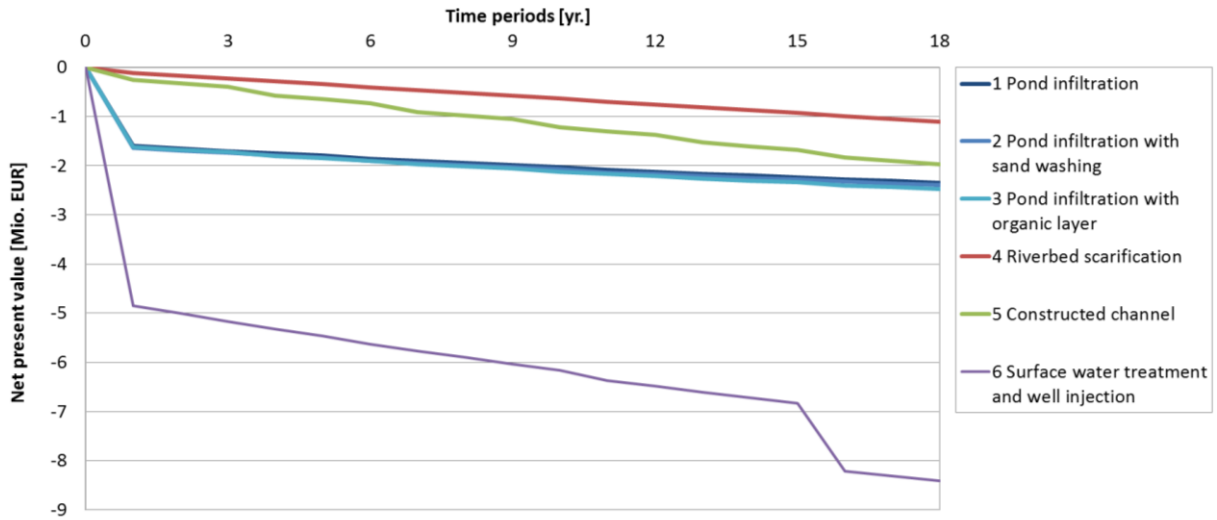

Figure 3-31: Net present value (NPV) of groundwater recharge scenarios in SVH over time

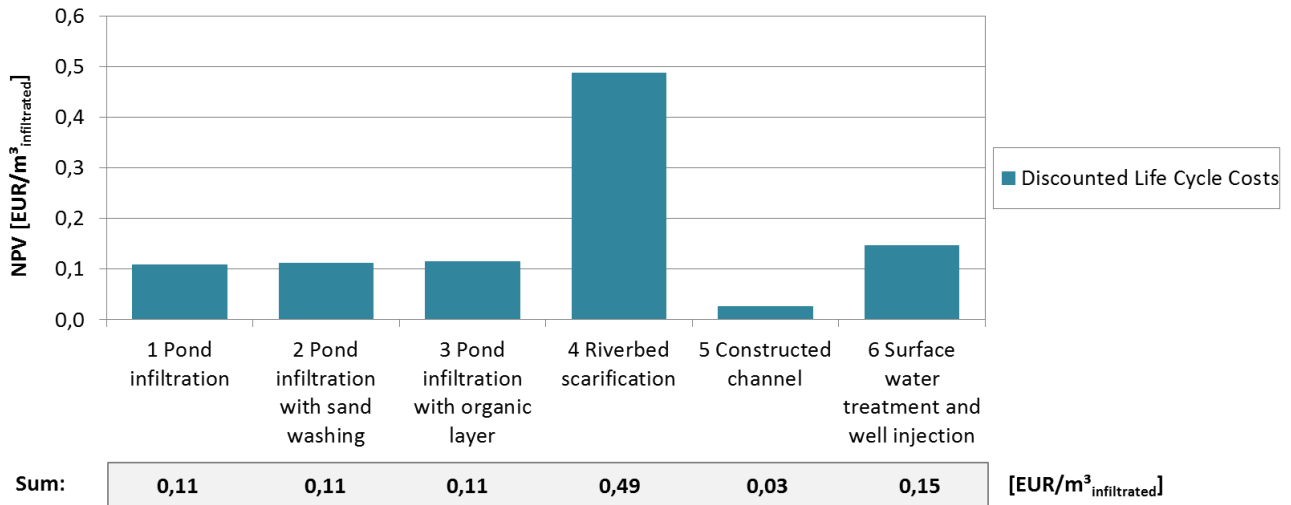

Figure 3-32: Net present value per m³ infiltrated water of groundwater recharge scenarios in SVH

### Sensitivity analysis

As discussed above, the infiltration rates expected with pond infiltration are based on assumptions, therefore sensitivities regarding this parameter have to be checked. In Figure 3-33 the relative NPV/m³ infiltrated is pictured under varying infiltration rates.

The results of this sensitivity analysis prove that pond infiltration systems can be a competing technology to surface water treatment and well injection if the real infiltration rate is somewhere between the mean and the max value of the assumed infiltration rate. But if the amount of infiltrated water per year is lower than expected, the 'conventional treatment system' becomes cheaper (0.19 EUR/m³ infiltrated for S1-3 compared to 0.13 EUR/m³ infiltrated for S6). Nevertheless, the very low costs of scarification in a constructed channel cannot be touched by any other system regardless of the infiltration rate assumed.

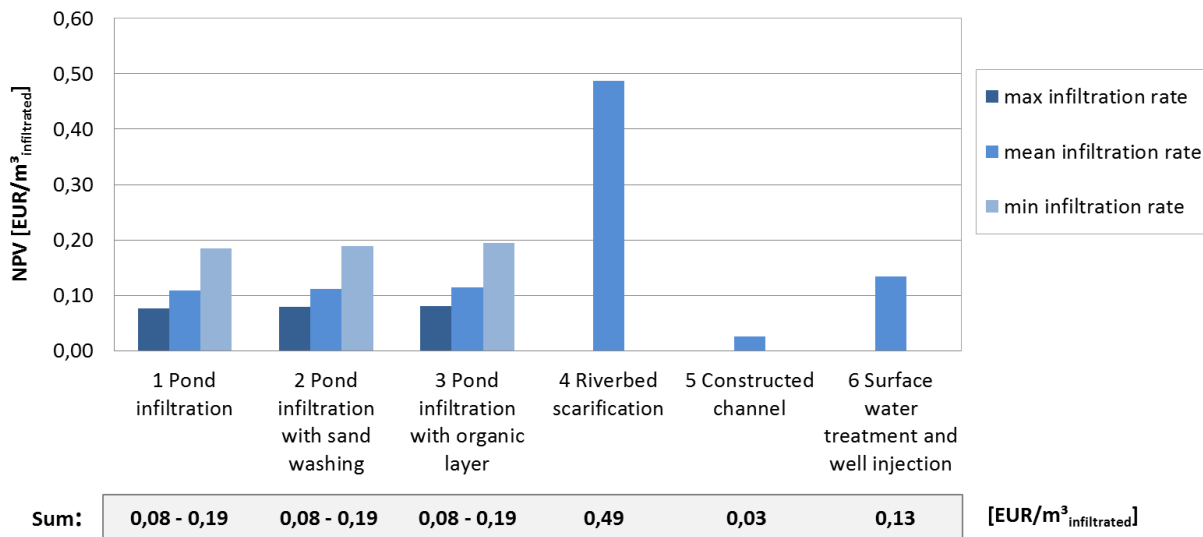

Figure 3-33: Net present value per m<sup>3</sup> infiltrated water of groundwater recharge scenarios in SVH under varying infiltration rates

Further sensitivity checks regarding the influence of the lifetime of infrastructure, as well as, discounting rates (3% / 5% / 7%) and the impact of inflation show that due to the generally minor impact of operational costs on life cycle costs, the statements about the benefits and costs of the technologies under consideration are not affected. The results for riverbed scarification show some variation from 0.36 EUR/m<sup>3</sup> infiltrated (7% discount, no inflation) to 0.61 EUR/m<sup>3</sup> infiltrated (3% discount, 3% inflation on energy, operating supplies and personnel). For all other scenarios these influences are negligible.

### 3.4.3.3 Summary of LCA/LCC results

A summary of LCA and LCC results is provided below Table 3-8. Improvements in local water quality by MAR treatment are mainly related to a reduction in freshwater eutrophication (lower P emissions) and lower ecotoxicity due to emerging contaminants removal. However, the latter aspect is only partially represented in this study, as only nine selected emerging contaminants are assessed and river water contains only 2 of those emerging contaminants in the ng/L range. Sensitivity analysis with tertiary WWTP effluent as feed reveals a higher impact on ecotoxicity by MAR treatment. On a global level, both ecotoxicity and human toxicity scores are increasing due to indirect emissions in electricity/chemicals/materials production.

Regarding impacts of construction and operation, LCA results show that pond infiltration is a low-energy treatment (0.1-0.3 MJ/m<sup>3</sup>) with low carbon footprint (10-25 g CO<sub>2</sub>-eq/m<sup>3</sup>). Even with regular sand washing strategy or organic layer for improved emerging contaminants removal, ponds are less energy-intensive than traditional riverbed scarification or well injection systems. This effect is also reflected in life-cycle costs, which are lower for pond infiltration than for riverbed scarification or well injection systems. Riverbed scarification has relatively high OPEX, while well injection has higher CAPEX than pond systems. Sand washing strategy (S2) or addition of organic layer (S3) do not increase life cycle costs of pond systems significantly.

### 3.4.4 Conclusions and Unique Selling Propositions

From the LCA and LCC assessment in this case study, the following unique selling propositions of MAR systems with simple pond infiltration for groundwater recharge could be deducted:



**USP1: Low-cost and low-energy groundwater recharge system with enhanced removal of organic emerging contaminants**

Comparable processes based on conventional technology (i.e. coagulation, filtration, and well injection) are more costly and are more energy intensive to build and operate than simple pond systems. Traditional strategies such as riverbed scarification are also requiring more energy and cause higher greenhouse gas emissions, and they are associated with higher life-cycle costs.

**USP2: Low-cost and low-energy upgrade possible with organic layer to improve organic emerging contaminants removal**

Upgrading the pond systems with an organic layer represents a low-cost and low-energy option to improve emerging contaminants removal in the pond systems. However, constant infiltration rates over time have to be guaranteed (e.g. by regular sand washing strategy) to maintain infiltration performance of the systems in a long term.

Table 3-8: Summary of LCA and LCC results for SVH case study  
(S1: Pond infiltration, S2: Pond infiltration + sand washing, S3: Pond infiltration + organic layer, S4: riverbed scarification, S5: scarification in channel, S6: surface water treatment + well injection)

	S1	S2	S3	S4	S5	S6
<b>Improvements in local water quality<sup>1</sup></b>						
Changes in freshwater eutrophication [mg P-eq/m <sup>3</sup> ]	-115	-115	-115	-115	-115	-46
Changes in ecotoxicity (freshwater) [10 <sup>-3</sup> CTU <sub>e</sub> /m <sup>3</sup> ] <sup>2</sup>	0	0	-0.24	0	0	0
Sensitivity: Changes in ecotoxicity (freshwater) with tertiary WWTP effluent as feed [10 <sup>-3</sup> CTU <sub>e</sub> /m <sup>3</sup> ] <sup>2</sup>	-0.2	-0.2	-2.4	-0.2	-0.2	-0.2
<b>Environmental impacts of construction and operation</b>						
Carbon footprint [g CO <sub>2</sub> -eq/m <sup>3</sup> ]	10	25	14	228	9	64
Energy demand (fossil) [MJ/m <sup>3</sup> ]	0.10	0.29	0.19	3.30	0.11	0.79
<b>Life Cycle Costs</b>						
Investment cost [EUR/(m <sup>3</sup> <sub>infiltrated</sub> /yr.)]	1.34	1.37	1.36	0.55	0.05	1.61
Operational cost [EUR/m <sup>3</sup> <sub>infiltrated</sub> ]	0.05	0.05	0.06	0.58	0.02	0.06
Total discounted life cycle cost over 30 years [EUR/m <sup>3</sup> <sub>infiltrated</sub> ]	0.11	0.11	0.11	0.49	0.03	0.15

<sup>1</sup> Only local direct emissions accounted, with river water as feed water

<sup>2</sup> calculated with USEtox® characterization factors developed in DEMEAU WA5

## 4 Hybrid Ceramic Membrane Filtration (HCMF) and Automatic Neural Net Control Systems (ANCS)

### 4.1 Technology description and relevant application areas

#### 4.1.1 Hybrid ceramic membrane filtration

In hybrid membrane processes, powdered activated carbon (PAC) adsorption can be combined with membrane filtration to remove emerging contaminants from drinking water or wastewater. Such hybrid filtration systems have been shown to provide a very effective broadband elimination of these contaminants. In a pilot plant combining PAC adsorption with subsequent ultrafiltration (PAC/UF) or sand filtration at a wastewater treatment plant in Switzerland, more than 80% of over 70 potentially problematic emerging contaminants could be removed at a PAC dose between 10 and 20 mg L<sup>-1</sup> (Margot et al. 2013). The removal of emerging contaminants is primarily due to the adsorption of these contaminants to PAC and subsequent separation of PAC from the water (Margot et al. 2013). Sedimentation and sand filtration are more common PAC separation steps, however membrane filtration has the advantages of complete PAC and bacteria retention, high virus removal and low space requirements (Löwenberg et al. 2014).

Membrane filtration is today mostly provided by polymeric membranes. Ceramic membranes would provide several advantages such as higher mechanical strength and durability, higher chemical resistance, higher permeability and longer life spans. However, in water treatment processes, their higher investment costs have so far limited their application (Park et al. 2015).

Ceramic membrane systems can achieve a stable operation and performance under high filtration flux rates, high feed water recovery rates and less chemical cleaning needs when compared to polymeric membranes. The strength of the ceramic membranes allows high backwash pressure to provide a very good backwash efficiency and makes them furthermore resistant to chemical pre-treatment of the water with oxidants (Lehman and Liu 2009). This would also enhance opportunities to combine oxidative treatment with hybrid membrane filtration. In addition, the appropriate quality of filtrate can be stably obtained without the risk of membrane breakage during a long lifetime (estimated over 10 years according to manufacturer information).

#### 4.1.2 Automatic Neural Net Control System (ANCS)

The concept for the automatic neural net control system (ANCS) was developed and demonstrated in the EU-Life project "Purifast". ANCS is able to adjust flux, filtration time and/or chemical cleaning frequency of a membrane filtration plant flexible to the requirements of the feed quality in order to achieve optimal performance and minimal chemical or energy demand. ANCS can be used either to optimize an existing plant or to cut down investment cost for new plants as these can be designed more ambitiously. However, to decrease investment costs by optimization of process performance is of great interest especially for ceramic membrane plants as their ability to compete strongly depends upon their costs.

ANCS takes into account the history of membrane fouling and the online measured water quality parameters (e.g. turbidity, UV254, temperature) and calculates the future development of membrane fouling in dependency of the operational settings flux, filtration time and chemical cleaning frequency. In "Purifast" ANCS has been applied in a small plant for the treatment of textile wastewater. Despite its high potential ANCS is not yet applied to large-scale water treatment processes. The main objective of

WP23 will thus be to adapt ANCS to the needs of such a large scale process and to demonstrate its benefits.

## 4.2 Case studies conducted in DEMEAU

Several case studies on HCMF processes were conducted in the DEMEAU project for wastewater and drinking water treatment, i.e.:

- **Hybrid ceramic membrane systems (HCMF)** for a wastewater treatment plant in Basel, Switzerland, using a modified pilot-scale membrane reactor used for secondary effluent. Work area 5 analyzed this pilot plant using LCA and LCC and results are presented below in section 4.3.
- **Ceramac® concept for drinking water treatment.** The new Ceramac® concept was implemented at full-scale at the drinking water treatment plant PWN in the Netherlands. The concept is based on an increased number of ceramic membranes in a pressure vessel, thus aiming to reduce footprint, piping and instrumentation and investment costs.

For ANCS, the following case study was conducted in the DEMEAU project for drinking water treatment:

- **ANCS** to control an ultrafiltration process at drinking water treatment plant WAG in Roetgen, Germany. Work area 5 analyzed this pilot plant using LCA and LCC and results are presented below in section 4.4.

## 4.3 CS 2.1: Hybrid ceramic membrane filtration (HCMF) in wastewater treatment

### 4.3.1 Case study description

A pilot-scale hybrid membrane process was tested by DEMEAU work area 2 in a municipal WWTP in Switzerland to remove emerging contaminants from its effluent. Based on previous research and installations using PAC/UF (powdered activated carbon/ultrafiltration) processes with polymeric membranes (Löwenberg et al. 2014), new ceramic UF membranes were tested at pilot-scale. In collaboration with work area 2 and based on their results Work area 5 estimated environmental and economic benefits and impacts for a full-scale design using LCA and LCC methods.

#### 4.3.1.1 Current wastewater treatment plant

The WWTP Birs in Birsfelden, Switzerland, was built in 1977 and treats wastewater from both municipalities and adjacent industries before the effluent is discharged to the Rhine River. With a capacity of ca. 150'000 PE (population equivalents), it is among the ten largest municipal treatment plants in Switzerland. The current design is based on multi-stage mechanical treatment, biological treatment in sequencing batch reactors (SBR) and phosphorus removal by simultaneous precipitation. Sludge is thickened before anaerobic digestion, and produced biogas is combusted on-site in a CHP plant. While electricity is sold to the grid, off-gas heat is used on-site for heating of digestors and buildings. Digested sludge is dewatered and incinerated.

#### 4.3.1.2 Emerging contaminant removal system

The hybrid membrane process was operated at pilot-scale as final treatment of the WWTP effluent. LCA and LCC were modelled for an anticipated full-scale design for this WWTP elaborated in collaboration with work area 2, and numbers presented here are based on this full-scale design (Figure 4-1). This section describes the theoretical full-scale design as a potential future scenario to upgrade the existing WWTP with either (i) hybrid ceramic membrane filtration (HCMF) or (ii) hybrid

polymeric membrane filtration (HPMF). The design is not related with any concrete future plans of the WWTP or the intention of the operator and was developed during a master project (Oberschelp 2014).

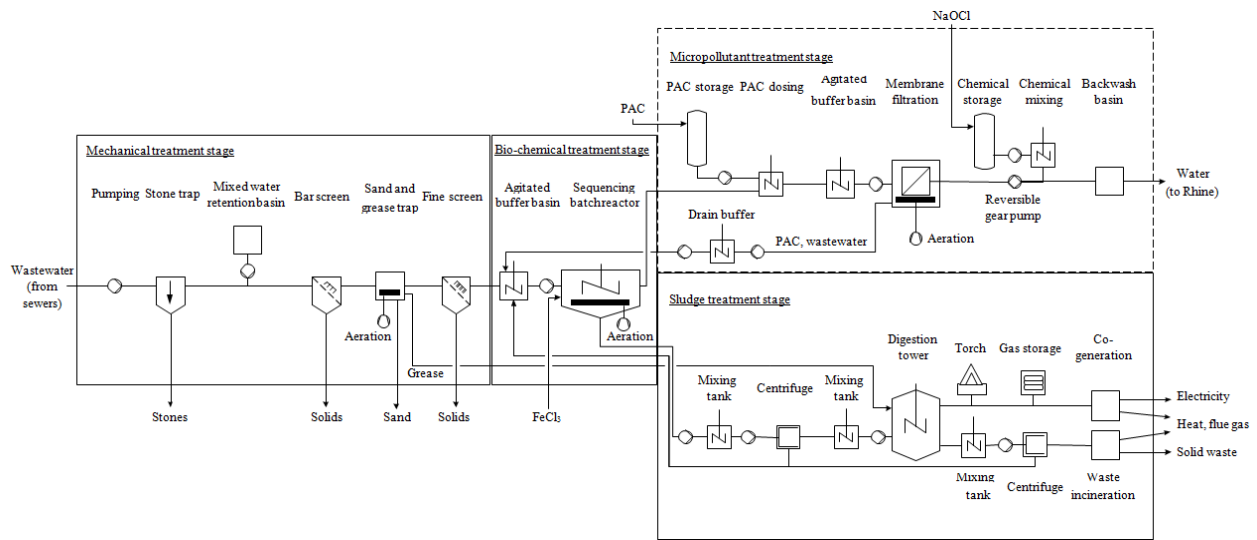

**Figure 4-1:** Process flowchart for the complete wastewater treatment plant at Birsfelden. It includes the three steps mechanical, bio-chemical and sludge treatment from the current plant and the extension scenario by a emerging contaminant removal stage (dashed box)

Based on pilot-scale tests, PAC would be dosed at around 15 mg/L to the effluent from the SBR tank and thoroughly mixed by an agitator in the theoretical full-scale implementation. After mixing, the effluent is stored in two agitated buffer basins to establish a continuous flow to the filter basin. The basin containing the submerged membrane modules would be slightly larger in the case of ceramic membranes (2'650 m<sup>3</sup>) than in the case of polymeric membranes (2'600 m<sup>3</sup>). Ceramic membranes used have a pore size of 0.2 μm (ItN Nanovation AG), while adequate polymeric membranes would have a pore size of 0.04 μm. Membranes are operated in outside-in mode, applying a suction pressure of 0.1-0.6 bar. The applied PAC and other particles including bacteria and viruses are separated from the permeate and PAC concentration at equilibrium reaches ca. 285 mg/L in the reactor. The contact time of the PAC is 1.4 h on average. The formation of a PAC layer on the membrane surface can be prevented by the injection of compressed air (0.3 m<sup>3</sup>/[m<sup>2</sup>\*h] for the full-scale scenario) below the membranes. At the same time the air would cause a turbulent flow regime to ensure proper mixing. The retained PAC and 5% of the water would be recycled back to the inlet of the SBR reactor, so that PAC adsorption capacity can be further utilized in the mainstream. Finally, PAC would be removed with excess sludge and go to incineration after passing digestion and dewatering. Backwash of the membranes would be done regularly. In addition, chemically enhanced backwash (CEB) would be done on a regular basis with sodium hypochlorite (NaOCl). Based on a pilot-scale operation a CEB twice per week 1.9 g/L OCl<sup>-</sup> for ceramic membranes seems realistic at full-scale.

### 4.3.2 LCA and LCC: Definition of goals and scope

#### 4.3.2.1 Definition of goals

The goal of the LCA was to compare environmental impacts of enhanced emerging contaminant removal by a hybrid ceramic membrane system to a comparable system with polymeric membranes and to the current status of the WWTP as reference. LCC should quantify and compare the additional costs of emerging contaminant removal over the life time of the systems. In the end, both analyses

combined should give a comprehensive assessment of the costs and benefits of ceramic and polymeric membrane filtration systems as additional treatment step for WWTP upgrade.

4.3.2.2 Functional unit

The functional unit is defined as “per 1 m<sup>3</sup> of treated wastewater in the full-scale treatment plant of Birsfelden”. Effluent water quality thresholds of the WWTP are defined by local standards. Improved quality due to enhanced removal of emerging contaminants by the membrane systems have been reflected in the respective water quality indicators.

4.3.2.3 System boundaries and investigated systems

The system boundaries include the construction and operation of the different wastewater treatment schemes. As such, it comprises the construction of plant infrastructure and process equipment and of operational efforts such as electricity and chemicals demand. Concerning the end-of-life phase, the demolition of the WWTP infrastructure is not included (Figure 4-2:). It is known from literature that the final removal phase of wastewater treatment plants is negligible in its environmental impacts in many cases (Vince et al. 2008).

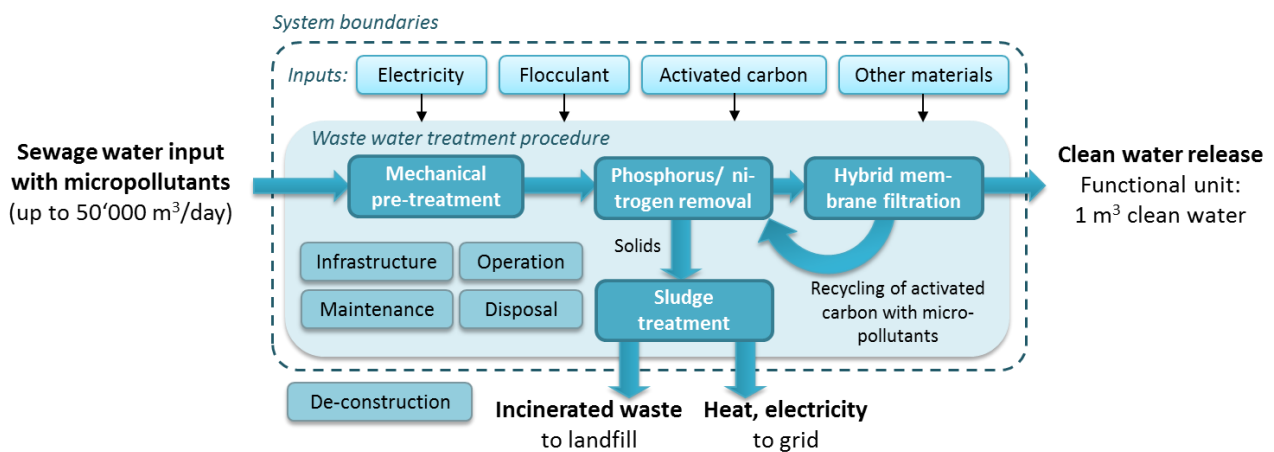

Figure 4-2: System boundaries of the LCA for the WWTP with hybrid membrane systems

We consider the following three scenarios:

- **BAU (business-as-usual):** wastewater treatment at the WWTP Birs based on mechanical treatment, biological treatment in a sequencing batch reactor (SBR) and PO<sub>4</sub> precipitation
- **BAU + HCMF:** Additional full-scale HCMF (hybrid ceramic membrane filtration) based on PAC with ceramic UF
- **BAU + HPMF:** Additional full-scale HPMF (hybrid polymeric membrane filtration) based on PAC with polymeric UF

4.3.2.4 LCA and LCC inventory

Table 4-1 summarizes key information for the BAU WWTP operation (AIB 2012), current water emissions and removal efficiencies of PAC followed by ultrafiltration or sand filtration based on studies in Switzerland (Sterkele and Gujer 2009; Margot et al. 2013). Annex-C provides detailed life cycle inventory information as modelled in the reference, the ceramic membrane and the polymeric membrane scenarios.

Since not all investment costs were available from the WWTP, some costs had to be taken from literature and corrected in order to account for deviations in time and location. A detailed list of the

required process equipment and the infrastructure for the plant extension together with estimated lifetimes is given in Annex-C. Membrane prices were based on vendor quotes. Due to the still low production quantities, prices for ceramic membranes can only be estimated at the current time. In the following investigations costs for ceramic membrane modules are assumed to be about 200 EUR/m<sup>2</sup> and polymeric membrane modules are expected to cost about 60 EUR/m<sup>2</sup>.

**Table 4-1: Summary of life cycle inventory of BAU WWTP operation (AIB 2012); COD, TN and TP emissions into water of BAU WWTP (Lüthy 2014); and emerging contaminants and their removal by PAC followed UF or sand filtration (available data from Swiss wastewater from Sterkele and Gujer 2009 and Margot et al. 2013) for PAC doses between 10 and 20 mg/L. Detailed life cycle inventory data are provided in Annex-C**

Parameters	Unit	Value	Removal efficiency of HCMF or HPMF (%)
<b>BAU WWTP operation</b>			
Total amount of water treated	m <sup>3</sup> /yr.	11'163'000 <sup>1</sup>	
Net electricity consumption from the grid	kWh/yr.	3'740'000 <sup>1</sup>	
Ferric chloride (as 13.8% FeCl <sub>3</sub> )	kg Fe/yr.	212'000 <sup>1</sup>	
Heat production from co-generation and incineration	kWh/yr.	9'912'744 <sup>1</sup>	
Electricity production	kWh/yr.	1'585'146 <sup>1</sup>	
<b>Emissions into water of BAU WWTP</b>			
Chemical Oxygen Demand (COD)	mg/L	6'910 <sup>2</sup>	
Nitrogen (TN)	mg/L	4'987 <sup>2</sup>	
Phosphorus (TP)	mg/L	0.512 <sup>2</sup>	
Antipyrine/ Phenazone	ng/L	252 <sup>3</sup>	62 <sup>3</sup>
Atrazin	ng/L	14 <sup>4</sup>	74 <sup>4</sup>
Bezafibrate	ng/L	595 <sup>4</sup>	79 <sup>4</sup>
Bisphenole A	ng/L	1'028 <sup>4</sup>	83 <sup>4</sup>
Benzotriazole	ng/L	4'300 <sup>5</sup>	99 <sup>5</sup>
Caffeine	ng/L	820 <sup>4</sup>	65 <sup>4</sup>
Carbendazim	ng/L	132 <sup>4</sup>	93 <sup>4</sup>
Carbamazepine	ng/L	461 <sup>4</sup>	93 <sup>4</sup>
Diclofenac	ng/L	4'063 <sup>5</sup>	76 <sup>5</sup>
Diazepam	ng/L	259 <sup>3</sup>	89 <sup>3</sup>
Diuron	ng/L	70 <sup>4</sup>	82 <sup>4</sup>
Estrone	ng/L	71 <sup>4</sup>	92 <sup>4</sup>
Gemfibrozil	ng/L	265 <sup>4</sup>	76 <sup>4</sup>
Ibuprofen	ng/L	952 <sup>4</sup>	83 <sup>4</sup>
Iopromide	ng/L	4'141 <sup>4</sup>	54 <sup>4</sup>
Mecoprop	ng/L	434 <sup>5</sup>	77 <sup>5</sup>
Metoprolol	ng/L	653 <sup>4</sup>	95 <sup>4</sup>
Metronidazole	ng/L	567 <sup>4</sup>	79 <sup>4</sup>
Oxazepam	ng/L	350 <sup>4</sup>	69 <sup>4</sup>
Primidone	ng/L	97 <sup>4</sup>	51 <sup>4</sup>
Propiconazole	ng/L	40 <sup>4</sup>	66 <sup>4</sup>
Sulfamethoxazole	ng/L	217 <sup>5</sup>	54 <sup>5</sup>
Terbutryen	ng/L	19 <sup>4</sup>	80 <sup>4</sup>
Trimethoprim	ng/L	158 <sup>4</sup>	94 <sup>4</sup>

<sup>1</sup> AIB 2012; <sup>2</sup> Lüthy 2014; <sup>3</sup> Sterkele and Gujer 2009, <sup>4</sup>Margot et al. 2013 and <sup>5</sup>Löwenberg pers. comm.

4.3.2.5 Assumptions

Several assumptions were made to fill the gap between required data and collected data:

**Current WWTP:** The generic WWTP process from the ecoinvent v2.2 database ‘Wastewater treatment plant, class 2/CH/I U’ was used with an annual wastewater volume treated: 14'400'000 m<sup>3</sup>/year compared to 11'163'000 m<sup>3</sup>/year at the actual WWTP. Furthermore, a lifetime of 30 years was assumed.

**Membrane system production and disposal:** The production of the membrane systems was mainly based on material balances based on manufacturer data (Annex-C).

- Ceramic membrane system: each membrane rack with 64 m<sup>2</sup> of filtration surface area was assumed to consist of a stainless steel frame including the aeration system and 16 membrane modules (Figure 4-3, left panel). Each membrane module contains 35 ceramic membranes and two injection molded polyurethane (PUR) connector pieces. The membranes are made from grinded and sintered aluminium oxide (Al<sub>2</sub>O<sub>3</sub>) with carboxymethyl cellulose as binder.
- Polymeric membrane system: each membrane rack with 1'580 m<sup>2</sup> polyvinylidene fluoride (PVDF) membranes (Figure 4-3, right panel) was assumed to consist of a stainless steel frame including the aeration system. Since the production of PVDF is currently not available as ecoinvent v2.2 process, the ecoinvent v3.0 process for the production of the chemically similar polymer polyvinyl fluoride (PVF) has been adapted for use (Annex-C). The solvent for PVDF membrane casting is selected to be n-methyl-2-pyrrolidone (NMP) according to literature data (Yeow et al. 2004).

The disposal of the membrane systems at the end of their lifetime is included by the standard Swiss waste treatment assumptions made by ecoinvent 2.2. This has been adjusted to recycle 100% of the steel since it is used for the membrane systems in large quantities and can be disassembled, separated and recycled (Annex-C).

**PAC production:** Production parameters of activated carbon usually are corporate secrets so it is difficult to obtain detailed primary data. Activated carbon production in this work is based on literature data from Bayer et al. (2005) which were validated and corrected by activated carbon producers (Table 4-2).

Table 4-2: Impacts of production of 1 kg of PAC according to Bayer et al. 2005, adjusted by the PAC SAE Super producer Cabot Norit Nederland B.V. (Muller 2014, pers. comm.) and Thommen-Furler AG (Wysser 2014, pers. comm.)

Description	Amount per kg PAC
Hard coal input	4 kg
Electricity input	1.6 kWh
Steam input	12 kg
Natural gas input	0.28 m <sup>3</sup>
CO <sub>2</sub> emission from transportation	0.2-0.3 kg

**Membrane lifetime:** The membrane lifetime is subject of uncertainty since no membranes have been in use under similar operating conditions for extended periods of time. For the ceramic membranes, the producer of the membranes chosen for this study guarantees a lifetime of about nine years (Sawatzki 2014, pers. comm.) while a lifetime of up to 15 years is estimated in literature (Remy 2013). Thus an average lifetime of 12 years is assumed. The polymeric membranes have a guaranteed lifetime of 2

years with potential lifetimes of up to 12 years (Siegenthaler 2014, pers. comm.). Therefore the estimated average lifetime in this work is 7 years.

**WWTP infrastructure lifetime:** Lifetimes of WWTP infrastructure and process equipment are assumed in compliance with similar projects based on literature (Kanton Basel-Landschaft 2003).

**Cost:** Since not all investment costs were available, some had to be taken from literature and corrected in order to account for deviations in time and location. A detailed list of the required process equipment and the infrastructure for the plant extension together with estimated lifetimes is given in Annex-C. Membrane prices were based on vendor quotes. Due to the still low production quantities, prices for ceramic membranes can only be estimated at the current time. In the following investigations costs for ceramic membrane modules are assumed to be about 200 EUR/m<sup>2</sup> and polymeric membrane modules are expected to cost about 60 EUR/m<sup>2</sup>.



**Figure 4-3:** Left panel: Ceramic membrane rack inside a membrane basin consisting of 16 membrane modules and a stainless steel frame (Sawatzki 2014); right panel: change of a ZeeWeed 500D polymeric membrane rack consisting of PVDF membranes and a stainless steel frame (GE 2013)

### 4.3.3 Results and discussion

#### 4.3.3.1 LCA impact assessment

#### Overall environmental impacts and benefits of all scenarios

Figure 4-4 shows the LCA results of the BAU scenario, i.e. the current WWTP without dedicated removal of emerging contaminants, compared to the wastewater treatment with an additional HCMF and HPMF system for all studied indicators. For all indicators, hybrid ceramic membrane systems have a slightly but not significantly better environmental performance compared to hybrid polymeric membrane systems.

Hybrid membrane filtration reduces the impact of freshwater eutrophication (by -34% and -33% respectively for the ceramic and polymeric membrane), human toxicity potential non-cancer (by -46% and -43% respectively for the ceramic and polymeric membrane) and freshwater ecotoxicity (by -34% and -29% respectively for the ceramic and polymeric membrane) compared to the current WWTP. On the other hand, fossil cumulative energy demand (CED) is increased by +20% and +22% respectively for HCMF and HPMF, and the nuclear CED by +87% and +110%. Related to the fossil CED the global warming potential increases by +205% and +216% respectively for HCMF and HPMF. There are also some net increases in terrestrial acidification potential (by +24% and +28% respectively for the ceramic and polymeric membrane), marine eutrophication potential (by +3% and +8% respectively for the ceramic and polymeric membrane), particulate matter formation (by +35%



and +43% respectively for the ceramic and polymeric membrane) and human toxicity potential cancer (by +58% and +72% respectively for the ceramic and polymeric membrane). The most relevant indicators are described in more detail below.

These benefits and additional impacts reflect required trade-offs between emerging contaminant removal by PAC and membrane technologies and additional material and energy requirements for these technologies and associated impacts.

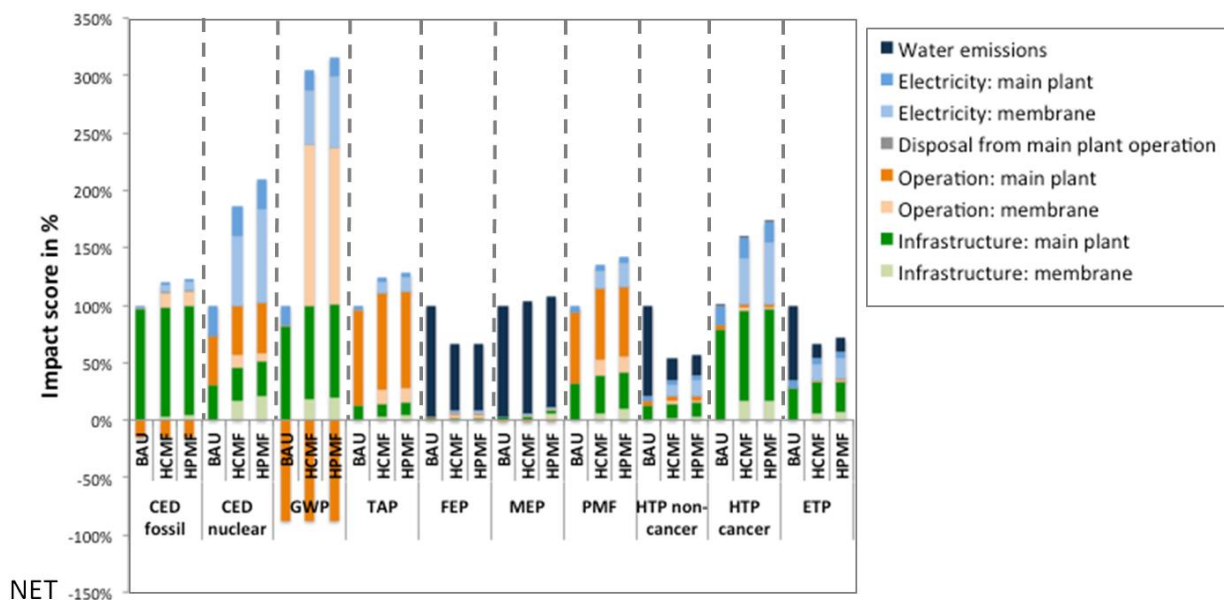

CED fossil: Cumulative Energy Demand fossil, CED nuclear: Cumulative Energy Demand nuclear, GWP: Global Warming Potential, TAP: Terrestrial Acidification Potential, FEP: Freshwater Eutrophication Potential, MEP: Marine Eutrophication Potential, PMF: Particulate Matter Formation, HTP non-cancer: Human Toxicity Potential non-cancer, HTP cancer: Human Toxicity Potential cancer, ETP: Ecotoxicity Potential

Figure 4-4: Overall relative LCA impact assessment of the BAU, HCMF and HPMF scenarios for the different indicators

**(Eco)toxicity results without extrapolation**

In this initial assessment, the freshwater ecotoxicity and human toxicity (cancer and non-cancer) of direct emissions into a receiving water body are calculated based on 25 substances covered in the USEtox database and/or with characterization factors (CFs) developed within the DEMEAU project (Figure 4-5). The process of CFs development for the DEMEAU project have been described by Remy et al. 2015. The additional removal of emerging contaminants by PAC adsorption in combination with hybrid polymeric or ceramic membrane processes leads to a net benefit in terms of ecotoxicity and human toxicity non-cancer (Figure 4-5A&C). Compared to the current WWTP, the addition of a hybrid membrane process reduces impacts on freshwater ecotoxicity by -34% (ceramic) or -29% (polymeric) and impacts on human toxicity non-cancer by -46% (ceramic) or -43% (polymeric). These benefits are the net values of locally reduced discharges of emerging contaminants into the receiving water body (water emissions in Figure 4-5) against some added global impacts from membrane operation and additional infrastructure of +14% and +19% for freshwater ecotoxicity, and +12% and +14% for human toxicity non-cancer for the hybrid ceramic and hybrid polymeric membrane processes, respectively. When comparing these net benefits for the total wastewater treated at the WWTP during one year (11'163'000 m<sup>3</sup>) to the (eco)toxicological impacts produced by an 'average' European person during one year, these represent the impacts of more the 100 persons in terms of reduced freshwater ecotoxicity and of more than nine persons in terms of human toxicity non cancer. The hybrid ceramic and polymeric membrane processes produce a net impact of +58% (overall 1.52E-8 CTUh/m<sup>3</sup>) and +72% (overall 1.66E-8 CTUh/m<sup>3</sup>) compared to the BAU scenario,

respectively, for human toxicity cancer (Figure 4-5B). The human health, cancer effect results are dominated by heavy metals emissions, i.e. chromium(VI), from additional electricity production for membrane operation (+ 3.75E-9 and +5.10E-9 CTUh/m<sup>3</sup> treated for HCMF and HPMF, respectively) and reinforcing steel production for additional infrastructure for membrane systems (+ 1.61E-9 and +1.66E-9 CTUh/m<sup>3</sup> treated for HCMF and HPMF, respectively) such as chromium steel for membrane racks. For electricity production, some Cr(VI) leaches from the distribution network infrastructure impregnated with chromium salt coating. For reinforcing steel production, Cr(VI) is mainly the leaching from disposal of slag from unalloyed electric steel production to residual material landfill. Metal toxicity, as modelled in the USEtox model, rely on characterization factors specified as ‘interim’, due to the relatively high uncertainty associated with estimates of fate, exposure and effects for this substance group. In contrast to organic compounds, for which the substance-to-substance variations in transport properties can be attributable to basic chemical properties such as solubility ratios, variations in transport properties for inorganic substances depend in complex ways on a range of media properties that are not considered in the USEtox model (Huijbregts et al. 2010). Furthermore, there is also an uncertainty related to the metal emissions inventory. Indeed, for example in the disposal of slag from unalloyed electric steel production, how much chromium(VI) is emitted? This estimation is based on emissions models over 60’000 years in ecoinvent v2.2.

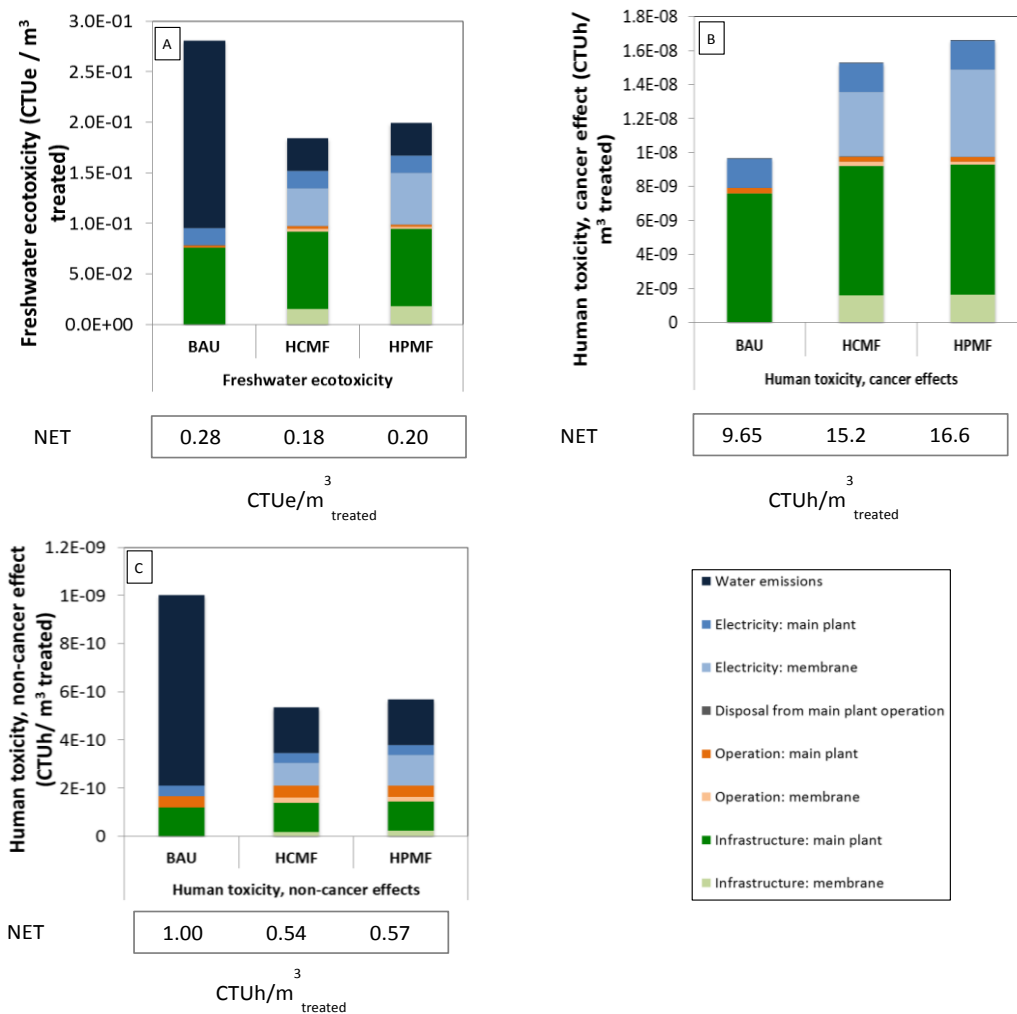

Figure 4-5: Freshwater ecotoxicity (A); human toxicity, cancer effect (B); and human toxicity, non-cancer effect (C) of WWTP Birs effluents: BAU, BAU+HCMF and BAU+HPMF scenarios (note: CTU values are not directly comparable with the other endpoint impact categories)

**(Eco)toxicity results with extrapolation**

Given that the previous results are representative of only 25 monitored substances, we extrapolated the (eco)toxicity score to the currently known emerging contaminant load present in municipal wastewater. Table 4-3 shows the key extrapolation parameters. The extrapolation was based on the average total mass of emerging contaminants detected in studies conducted on Swiss wastewater (Margot et al. 2013) as well as on operational data from the wastewater treatment plant Sindelfingen (Schwentner 2011). PAC removal rates were derived by Margot et al. (2013) based on measurements from wastewater in Lausanne, Switzerland.

**Table 4-3: Key parameters to estimate the entire emerging contaminant load toxicity**

Parameter	Assumption
Emerging contaminant load 9.62E-05 kg.m <sup>-3</sup>	Total emerging contaminant load was estimated as an average of the load reported in Schwentner (2011) (1.16E-04 kg.m <sup>-3</sup> ), Margot et al. (2013) (8.18E-05 kg.m <sup>-3</sup> ) and Goetz et al. (2010) (9.05E-05 kg.m <sup>-3</sup> )
Toxicity uncertainty 3 scenarios: 1 <sup>st</sup> quartile, median and 3 <sup>rd</sup> quartile of USEtox organic substances toxicity	Given the lack of knowledge on the average toxicity of the entire emerging contaminant load, we generated a toxicity characterization factor for 3 scenarios: the 1 <sup>st</sup> quartile, median and 3 <sup>rd</sup> quartile of the toxicity of the 3074 organic substances covered in USEtox
Substance removal 76% removal rate	We assume 76% of substances' load is removed over the membrane treatment (average over 26 monitored substances in Margot et al. 2013, Sterkele et Gujer 2009 and Löwenberg 2014)

Figure 4-6 provides (eco)toxicity results for the reference and the two hybrid membrane process scenarios with a low (1<sup>st</sup> quartile of USEtox organic substances), average (median of USEtox organic substances) and high toxicity (3<sup>rd</sup> quartile of USEtox organic substances) of the total emerging contaminants load estimation. The ecotoxicity impact results show that the emerging contaminant emissions represent a significant contribution to the ecotoxicity impact from an average to high toxicity, i.e. from the median to 3<sup>rd</sup> quartile of organic substances in USEtox. Based on our initial assumption, the PAC and membrane filtration reduces the impact of emerging contaminants in parallel with the removal rate by 76%. The overall ecotoxicity score (encompassing both direct and indirect emissions) is reduced by -19% and -12% for ceramic and polymeric membranes compared to the scenario without membrane filtration for the median toxicity scenario and by -69% and -68% for the 3<sup>rd</sup> quartile organic substances scenario. This leads to the conclusion that WWTP membrane filtration can foremost reduce ecotoxicity, i.e. serve as protecting rivers and lakes from negative impact of WWTP effluent. The human health, cancer effect results show that the emerging contaminant emissions from wastewater represent a low contribution to the impact on human health, cancer effect, for all toxicity ranges. The impact score is dominated by background toxicity resulting in an increase of +54% for the ceramic membrane system and +68% for the polymeric membrane system, compared to the BAU WWTP for median toxicity. As stated above, the toxic impact of Swiss electricity production through cancer effect is mainly due to Cr(VI) leaching from the distribution network infrastructure impregnated with chromium salt coating (around 70% of the total human health, cancer effect impact of Swiss electricity). The difference between the two systems is caused by the production of NMP for use as polymer solvent while the rest is mainly due to the emissions in energy generation. The human health, non-cancer effect results show a similar trend as for ecotoxicity: the emerging contaminant emissions reduction represent a significant improvement for the impact on human health, non-cancer effect from an average to high toxicity, i.e. from the median to 3<sup>rd</sup> quartile of organic substances in USEtox. The overall ecotoxicity score (encompassing both direct and indirect emissions) is reduced by 28% and 23% for ceramic and polymeric membranes compared to the scenario without membrane filtration for the median toxicity scenario and by 68% and 67% for

the 3<sup>rd</sup> quartile organic substances scenario. In summary, when extrapolating the toxic impact to the entire emerging contaminant load, the emerging contaminant emissions represent a significant contribution to the human health (non-cancer) and freshwater ecotoxicity impact in case the toxicity of the emerging contaminant load is average to high, i.e. between the median and the 3<sup>rd</sup> quartile of organic substances CFs in USEtox.

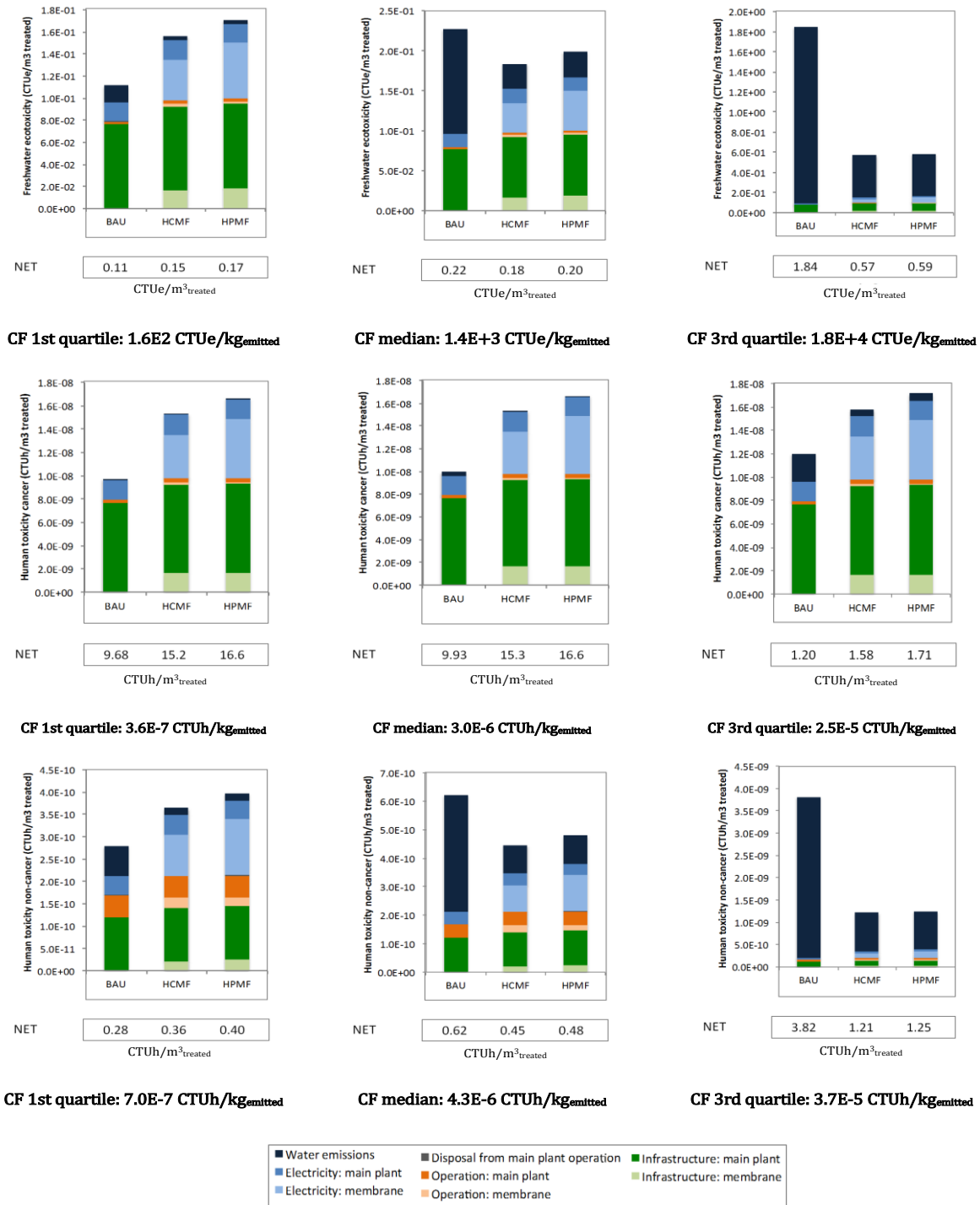

Figure 4-6: Extrapolation of the emerging contaminant entire load contribution to eco- and human toxicity effect of the current Birsfelden and the 2 membrane scenarios (note different y-axis in 3rd quartile)

## Climate change

Figure 4-7A presents the overall climate change results and Figure 4-7B presents further details on current and membrane operation.

In the BAU scenario of the current WWTP, the main climate change impacts stem from the main plant operation and current infrastructure (concrete and metal). The current WWTP operation appears as a benefit in Figure 4-7A. The produced heat of  $7.9 \times 10^{-3}$  kWh/m<sup>3</sup> and electricity of  $5.1 \times 10^{-3}$  kWh/m<sup>3</sup> at the combined heat and power plant and in sludge incineration (0.285 kWh/m<sup>3</sup>) overcompensate the climate change impact of operating the existing wastewater treatment plant. Among other inputs, the operation requires an electricity input of 0.335 kWh/m<sup>3</sup> and the off-site incineration a heat input of 0.249 kWh/m<sup>3</sup> (with data from AIB (2012) and ProRhenon (2014, pers. comm.), Annex A). The operation of WWTPs also produces direct emissions to the air (also see Annex A), including about 0.3 kg CO<sub>2</sub>/m<sup>3</sup> from sludge digestion, co-generation and off-site sludge incineration (Leckner et al. 2004; Lüthi 2014 pers. comm.) and  $2.9 \times 10^{-3}$  SO<sub>2</sub>/m<sup>3</sup> from sludge incineration (Leckner et al. 2004). Figure 4-7B provides a more detailed differentiation of the different components.

The additional hybrid ceramic and polymeric process increases the global warming potential by a factor of about 2 if considering only the impacts side. The global warming potential of the current WWTP is approximately balanced (0.02 kg/m<sup>3</sup>) due to energy recovery from sludge and comparably low carbon footprint of the Swiss electric energy mix. The additional global warming potential of the hybrid membrane process is mainly due to CO<sub>2</sub> emissions to air from PAC activation. The production of PAC requires a high energy input for steam activation of carbon at about 700-900 °C and 4 kg coal per kg of activated carbon output is consumed, the activated carbon being used as adsorbent for emerging contaminants dosed at 15 mg/L. Of the membrane operation (100%, 0.30-0.32 kg CO<sub>2eq.</sub>/m<sup>3</sup>), PAC steam activation produces ca. 52-54% (0.165 kg CO<sub>2eq.</sub>/m<sup>3</sup>), followed by electricity for membrane aeration with 16-22% (0.048-0.072 kg CO<sub>2eq.</sub>/m<sup>3</sup>), additional electricity, heat, coal and emissions of 13-16% (0.049-0.042 kg CO<sub>2eq.</sub>/m<sup>3</sup>) and steam for PAC production with 13-14% (0.042 kg CO<sub>2eq.</sub>/m<sup>3</sup>). Overall, the PAC itself dosed at 15 mg/L effluent produces ca. 0.21 kg CO<sub>2eq.</sub>/m<sup>3</sup> treated effluent (ca. 17 kg CO<sub>2eq.</sub>/kg PAC). However, there is a high uncertainty because of insufficiently available data on the PAC production process. As a sensitivity analysis, producing 15 mg/L of charcoal with theecoinvent v2.2 process "charcoal, at plant, GLO" would generate ca. 0.15 kg CO<sub>2eq.</sub>/m<sup>3</sup>, which would reduce the impact of activated carbon production by around -25% compared to our default PAC production model.

There is a larger electricity demand of the polymeric membrane system than for the ceramic one mainly caused by the differences in electricity consumption for aeration of 3.6 MJ/m<sup>3</sup> for ceramic membranes and 5.4 MJ/m<sup>3</sup> for the polymeric membranes. This difference is caused by the increased membrane area demand of the polymeric membrane process due to lower transmembrane fluxes. Assuming the same area-specific aeration rate for both membrane types based on pilot trials, a higher total air injection is necessary for the polymeric system.

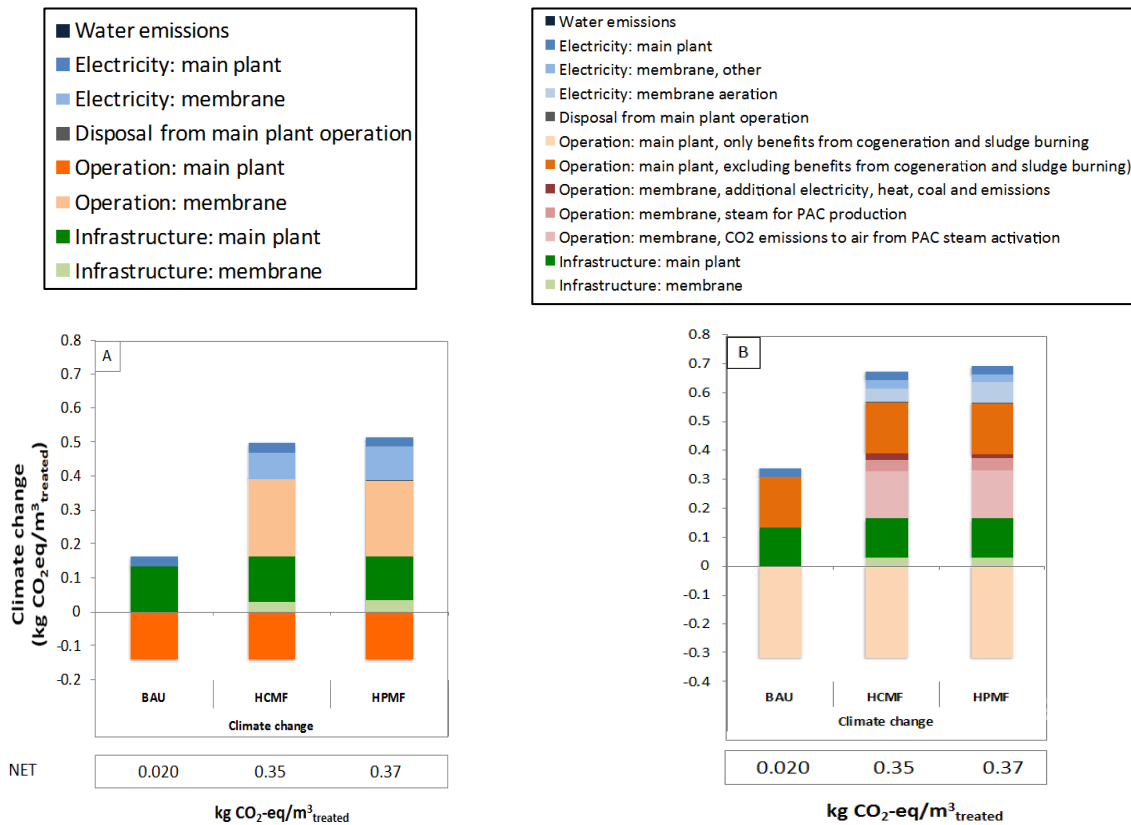

Figure 4-7: Climate change impacts of BAU WWTP, BAU WWTP with HCMF and BAU WWTP with HPMF scenarios with a global level of detail (panel a); and detail of current operation and membrane operation (panel b)

### Sensitivity analysis on membrane aeration for pressurized membranes

When extending the pilot tests to a full-scale system, the membrane operation could be optimized by several measures. Given that membrane operation has important energy requirements, we analysed the influence of using pressurized membranes on the climate change indicator. By using pressurized membranes for PAC separation, aeration demand could be completely avoided in a modified scenario. In the modified scenario using pressurized membranes for PAC separation, the contribution of the membrane operation on climate change compared to the original scenario could be reduced by 16% for the ceramic membrane and 22% for the polymeric membrane and the overall impact decreases by 7% for the ceramic membrane and 10% for the polymeric membrane.

### Cumulative energy demand (CED)

Figure 4-8A&B show the cumulative energy demand fossil and nuclear indicators for the three scenarios. The fossil cumulative energy demand (CED) for the BAU reference scenario is dominated by the main plant infrastructure, due to the low share of the Swiss electricity mix produced with fossil energy. The membrane operation then adds +20% and +22% respectively for the ceramic and for the polymeric membrane compared to the reference scenario. This increase is mainly related to the membrane operation and the coal used for activated carbon production.

The nuclear CED indicator is related to electricity production and 87% and 110% higher for the ceramic and polymeric membrane compared to the BAU scenario. This indicator is mainly related to

nuclear electricity production and is thus dominated by the electricity production, main plant operation and main plant infrastructure.

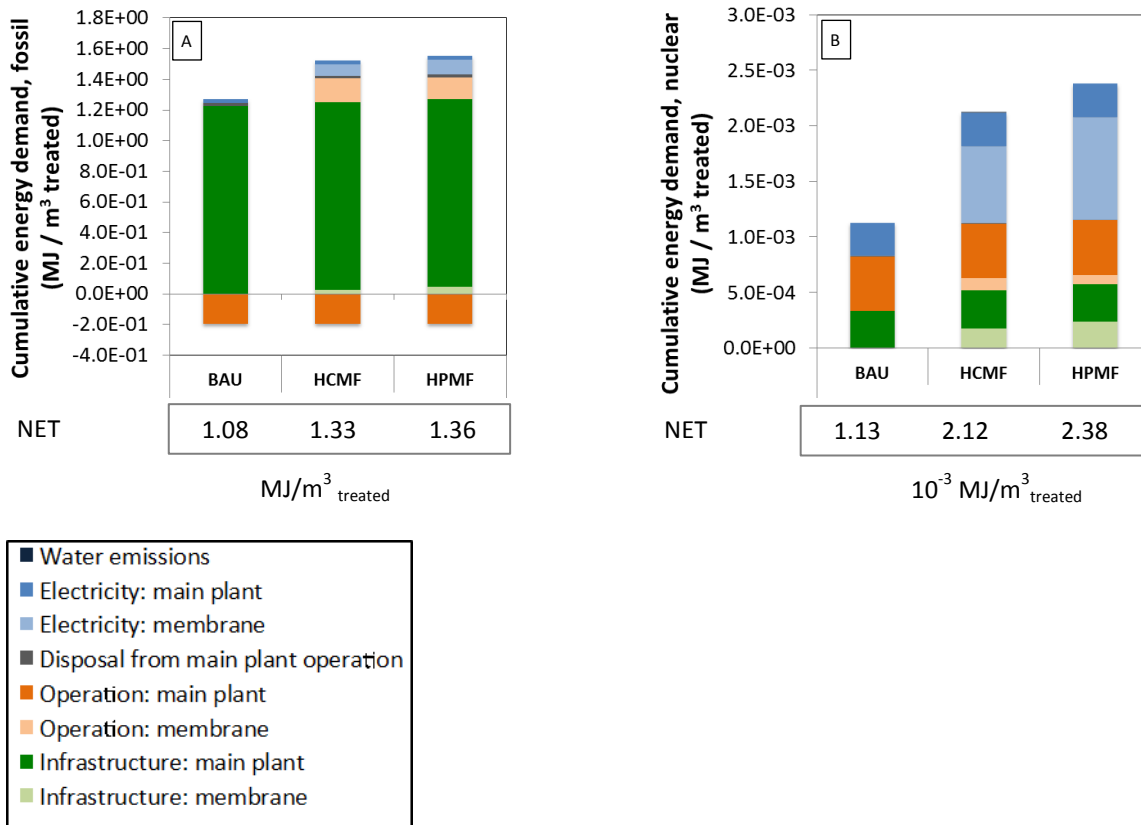

Figure 4-8: Cumulative energy demand fossil (A) and nuclear (B)

4.3.3.2 LCC assessment

To account for the costs of advanced wastewater treatment against emerging contaminants with hybrid ceramic and polymeric membrane filtration, capital expenditure (CAPEX) and operational expenditure (OPEX) of the two different membrane systems for a full-scale extension of the current treatment plant at Birsfelden were collected. CAPEX and OPEX were aggregated in order to compare the two systems on the basis of annual volume of wastewater treated EUR/(m<sup>3</sup><sub>treated</sub>/yr.) and (EUR/m<sup>3</sup><sub>treated</sub>, respectively).

**Capital costs for infrastructure**

According to local authorities, the total investment costs of the WWTP Birs were about 50 Mio. CHF (app. 41 Mio. EUR, calculated with mean exchange rate of 2013) in 2007 (Kanton Basel-Landschaft 2014). Additional investment costs for the extension of the WWTP by hybrid membrane filtration would consist of three major components: (1) buildings and streets; (2) technical equipment (basins, tanks, PAC dosing system, piping, blowers, pumps, mixers, membranes, and process control system); and (3) planning.

The estimated additional investment costs for a full-scale hybrid ceramic membrane filtration system of 19.5 Mio. EUR are +44% higher compared to the hybrid polymeric membrane filtration system (13.5 Mio. EUR) which results in 1.74 EUR/(m<sup>3</sup><sub>treated</sub>/yr.) for the ceramic and 1.21 EUR/(m<sup>3</sup><sub>treated</sub>/yr.)

for the polymeric membrane system, respectively (Figure 4-9). The largest fraction of these costs is due to the membrane price which is the only considerable difference between the membrane systems. As the costs for installation are assumed to be equal for both membrane types price differences are exclusively caused by membrane prices and disposal costs. The ceramic membrane costs of 12.1 Mio. EUR make up 63% of the total additional investment costs while the polymeric membranes share of 6.2 Mio. EUR is only 46%, which explains the high capital cost difference between both systems. Despite a 37.5% smaller filtration area demand of the ceramic membrane system, the higher assumed ceramic membrane costs of 200 EUR per m<sup>2</sup> instead of 60 EUR per m<sup>2</sup> for the polymeric membranes cause significantly higher total capital costs.

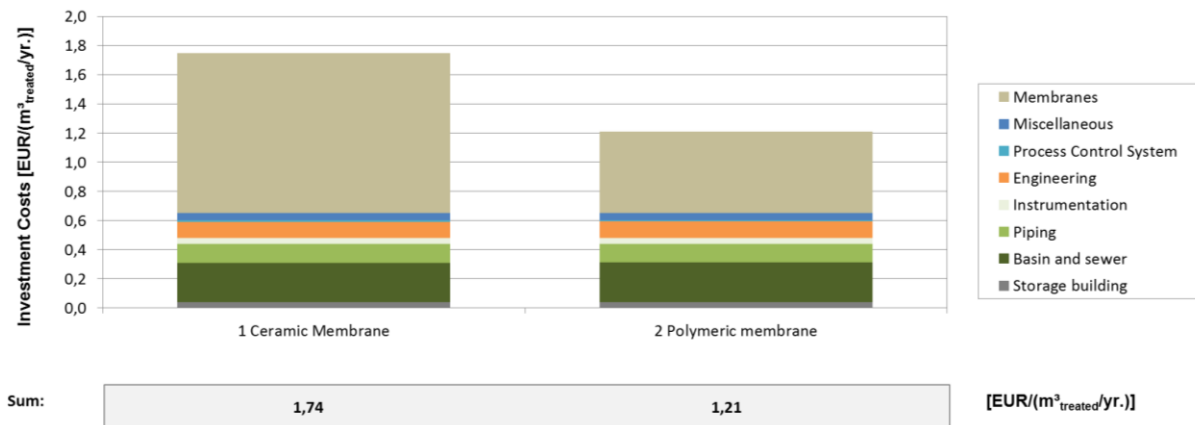

Figure 4-9: Specific investment costs per m<sup>3</sup> treatment capacity/yr. for full-scale extension of the current WWTP by emerging pollutant removal with hybrid ceramic and polymeric membrane filtration systems

Basins and new piping and channel requirements of around 250 m including concrete, excavation and gravel for foundations have the second highest impact on investment costs for both ceramic and polymeric system, but the difference in investment costs for these installations is negligible. Furthermore, these requirements represent one specific engineering scenario estimated for the case study WWTP and may significantly differ depending on the eventual full-scale design and also at other WWTPs. The difference in layout between the systems due to membrane arrangement does not change basin volumes and investment costs significantly. Other costs of the treatment facility are also identical because of unchanged material flows, residence times and the instrumentation. Since the project complexity remains the same as well, the costs for planning are not affected either.

### Operational costs

In contrast, the operating costs for the hybrid ceramic membrane filtration system (Figure 4-10) are about -14% lower than for the polymeric membrane system, resulting in a total of about -0.15 Mio EUR less operational costs per year. The difference is mainly caused by the reduced energy demand needed for the ceramic membrane process because the electricity consumption is the category that causes the second largest annual costs. For the ceramic membranes, they make up 49% (0.44 Mio EUR/yr.) of the operating costs while the electricity demand of the polymeric membranes accounts for 58% (0.61 Mio EUR/yr.) of their annual operating costs. This difference is caused by the additional energy demand of the polymeric membranes to aerate additional membrane area. Since the energy demand of aeration is responsible for up to 85% of the total energy demand, this difference in aeration energy is large enough to off-set the advantage in investment costs of polymeric membranes.

The costs for chemicals are another important factor for the overall operational costs. These are mainly caused by the costs for powdered activated carbon (PAC) at 0.03 EUR/m<sup>3</sup> (0.3 Mio EUR/yr.) while the differences between both membrane systems with regards to membrane cleaning and



regeneration are negligible and the tedious optimization of these recurring procedures has little influence on the overall annual costs. Instead, optimization of activated carbon use and aeration are promising opportunities to realize substantial cost savings.

Waste disposal costs for the activated carbon containing sewage sludge cause 12-13% of the operating costs and wages cause app. 3%. The additional revenues from net heat production and electricity production are below 1%. Contributions of these categories on the overall operating costs are therefore of minor importance.

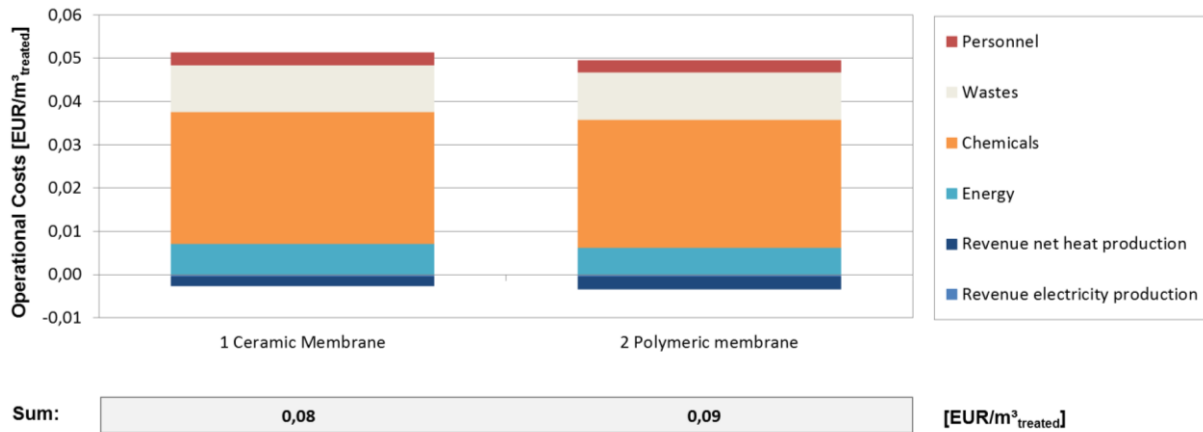

Figure 4-10: Operational costs per m<sup>3</sup> for a full-scale extension of the current treatment plant at Birsfelden by emerging contaminant removal with ceramic and polymeric membrane filtration systems

### Net present value (NPV) over the life cycle

The net present value (NPV) was calculated over the course of 30 years at an assumed discount rate of 3% without considering inflation and assuming that the wastewater treated per year remains constant over that time.

Over the course of 30 years, the net present value (NPV) of costs for ceramic membranes (47.9 Mio. EUR) is about +4% higher than those of polymeric membranes (46.1 Mio. EUR). With reference to the amount of wastewater treated in this time periods, cost for the ceramic membrane process are about 14.3 EUR-Ct/m<sup>3</sup> whereas the polymeric membrane process costs app. 13.8 EUR-Ct/m<sup>3</sup>.

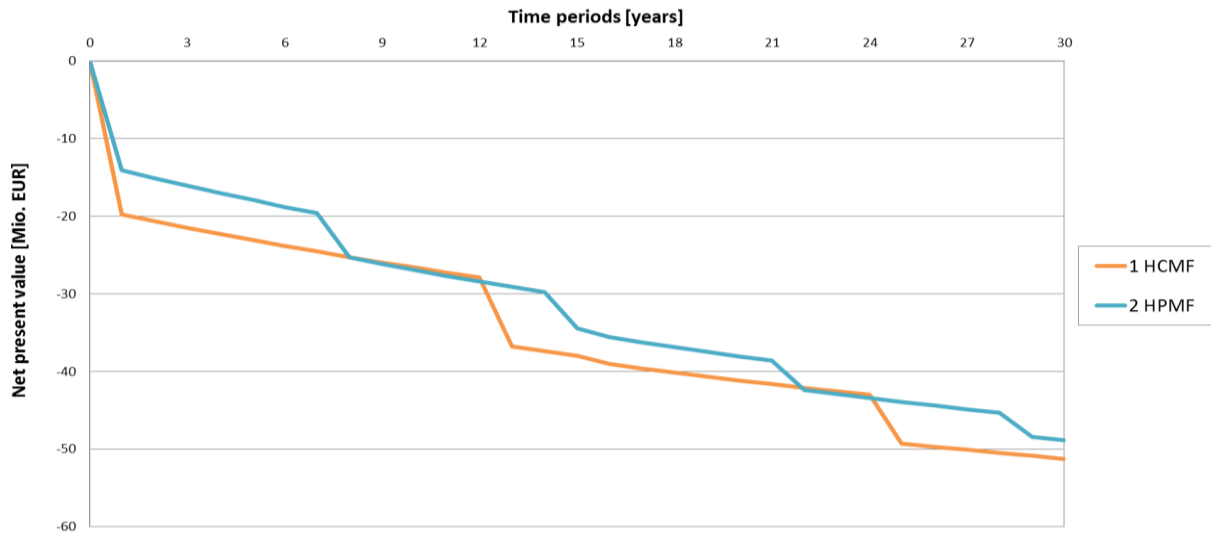

Figure 4-11: Net present value of an extension of the current treatment plant at Birsfelden by emerging contaminant removal with ceramic and polymeric membrane filtration over a time period of 30 years

### Sensitivity analysis

As the Swiss government provides a subsidy for technologies against emerging contaminants in WWTPs to lower the barriers for technology implementation, operator costs for the initial investment can be lowered by 75%. After the first replacement of equipment, full costs have to be paid by the operator causing an increased treatment cost for the polluters by ca. 11% (AIB 2009). This could give a certain advantage to ceramic membrane systems because of their expected longer lifetimes (12 years instead of 7 years) and due to the fact that cost increases for the other process equipment (e. g. pumps after 15 years, or process control systems after 10 years) have a minor impact. Taking into account this subsidy, the cost advantage shifts from polymeric membrane systems (36.3 Mio. EUR) to ceramic membrane systems (33.7 Mio. EUR) with NPV cost savings of 7.2 % for the latter system. Figure 4-12 depicts this effect by showing the NPV over 30 years per m<sup>3</sup> water treated for both membrane systems with and without funding included.

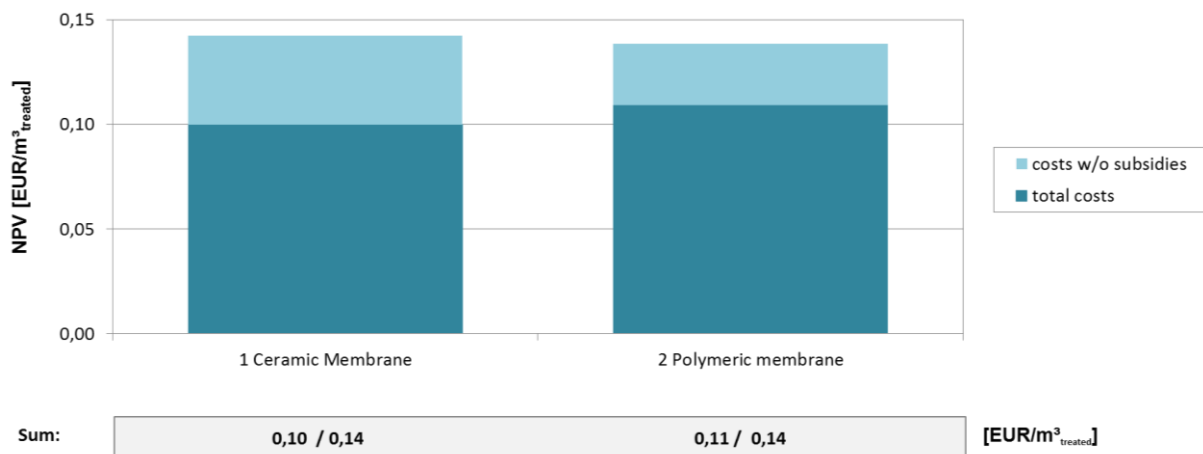

Figure 4-12: Net present value per m<sup>3</sup> treated water for extension of the current treatment plant at Birsfelden by emerging contaminant removal with ceramic and polymeric membrane filtration over a time period 30 years with and without a subsidy of 75% of initial investment costs

Membranes lifetimes are another decisive parameter for calculation NPV. If only the guaranteed lifetime of two years is met with for example the polymeric system, the NPV decreases by 92% (Figure 4-13). Although such massive discrepancies to the assumed lifetime are unlikely to happen, this could be a major problem for the plant operators because the treatment costs would deviate extremely from the calculated costs then. At the same time, a high polymeric membrane lifetime of 12 years can make the polymeric membrane system economically preferable over the ceramic membranes by a 15% NPV increase. As guaranteed, assumed and optimistic lifetimes for ceramic membranes show smaller variations, their impact on the overall NPV of these membrane systems is comparatively lower (-13% to +9%). Thus, the assumption on membrane lifetime is the most important parameter influencing the additional treatment costs and experience shows that membranes tend to have a longer lifetime than anticipated if well maintained (Wintgens 2015, pers. comm.). However, changes in membrane prices have an impact of up to 20% on NPV sensitivity as well.

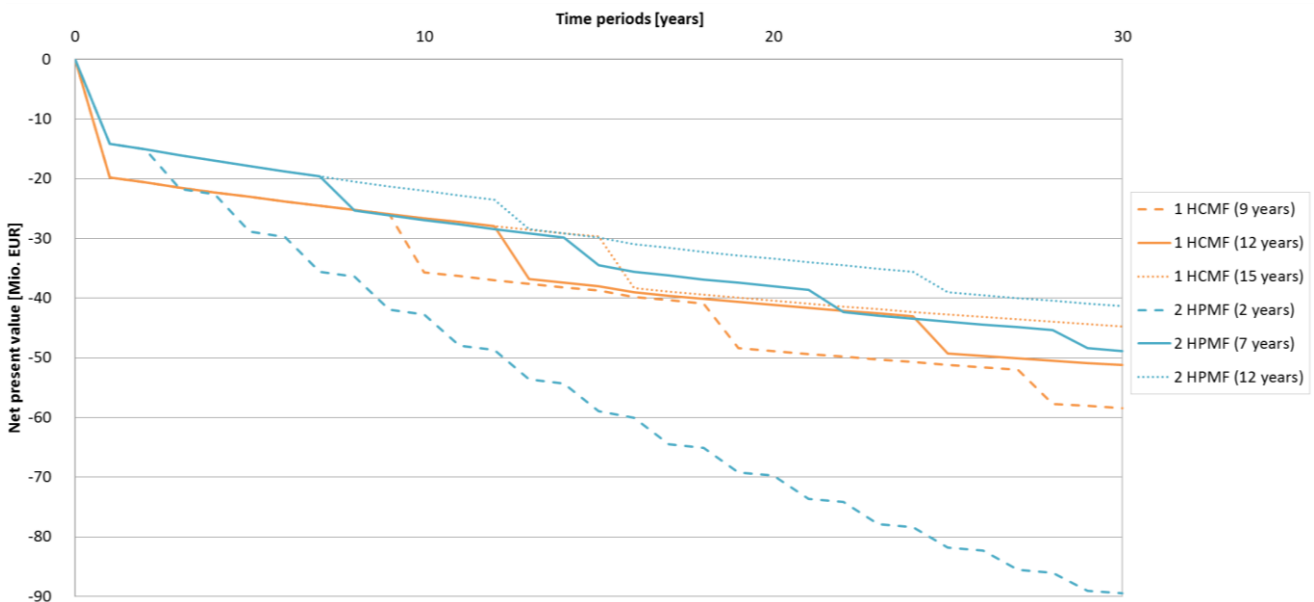

Figure 4-13: Net present value development of a full-scale extension of the current treatment plant at Birsfelden by emerging contaminant removal with ceramic and polymeric membrane filtration systems over a time period 30 years with varying membrane lifetimes (HCMF: 9 / 12 / 15 years; HPMF: 2 / 7 / 12 years)

If the electricity demand for aeration can be completely avoided by using pressurized membranes for PAC separation in a full-scale plant, annual operational costs could be lowered up to 40% for ceramic membranes and 51% for polymeric operation. All in all, this would lead to a major reduction of the NPV/m<sup>3</sup><sub>treated</sub> for both membrane systems. But due to its initially higher energy demand for aeration, polymeric membranes will now be clearly in favor by costing 10.6 EUR-Ct/m<sup>3</sup><sub>treated</sub> compared to 12.1 EUR-Ct/m<sup>3</sup><sub>treated</sub> for the ceramic membrane system.

#### 4.3.4 Conclusions and Unique Selling Propositions

From the LCA and LCC assessment in this case study, the following unique selling propositions of HCMF in wastewater treatment against emerging contaminants could be deducted:

- **USP1: Over the lifecycle of a wastewater treatment plant hybrid membrane filtration with ceramic membranes (HCMF) is about as expensive as with polymeric membranes (HPMF).** This is due to an expected longer lifetime of ceramic membranes leading to reduced needs for

replacement and related investment and disposal costs compensating for the higher initial investment costs.

From a cost point of view, polymeric membrane systems at the current time would be preferred over ceramic membranes. Additional investment costs for HCMF are currently much higher due to the higher membrane prices. Although the operational costs for HCMF are lower than those of the polymeric system, without taking into account subsidies, the NPV costs after 30 years of HCMF still exceeds those of the polymeric system by app. 1 Mio EUR – which in this case study translate however to differences of <math><0.01\text{ EUR/m}^3\text{ water treated}</math>. However, for this particular case study, ceramic membranes become advantageous compared to polymeric membranes for the operator taking into account the subsidies offered by the Swiss government.

- **USP2: The ecological performance of HCMF is slightly better than HPMF, due to a smaller membrane area required and therewith related lower aeration requirements.**

Ceramic membranes have a slightly but not significantly better environmental performance than polymeric membranes: There is no significant difference between the impact of the hybrid ceramic membrane and the polymeric membrane scenarios. The hybrid ceramic membrane comes as up to 5 % less impactful on climate change than the polymeric one due to lower electricity and heat requirements. These differences are mainly due to an increased aeration demand for the polymeric membranes.

- **USP3: The application of Powdered Activated Carbon (PAC) in combination with ceramic or polymeric membrane filtration provides a highly effective broadband elimination of emerging contaminants with complete particle retention, disinfection properties and no by-products. On the other hand PAC production also causes noteworthy environmental impacts especially with regard to the global warming potential.** The environmental profile should be improved thorough sensible sourcing and minimized PAC dosing by utilizing its maximum adsorption capacity and by exploring possible dosing optimization strategies with e.g. ANCS and/or bioassay applications. The sourcing and the use of regenerative PAC raw materials such as agricultural by-products (e.g. fruit stones and nut shells) may provide improvement opportunities.

**Substantial (eco)toxicological benefits in WWTP effluent:** Life cycle assessment results show that hybrid ceramic and polymeric membrane filtration processes significantly reduce the ecotoxicity and human toxicity impacts of WWTP effluents due to the removal of emerging contaminants. Regarding (eco)toxicity reduction, results showed that the environmental benefit of PAC and membrane emerging contaminants removal is important for freshwater ecotoxicity results (reduces by -34% for ceramic or -29% for polymeric) and for human toxicity non-cancer effect (reduces by -46% for ceramic or -43% for polymeric). When extrapolating the toxic impact to the entire emerging contaminant load, the emerging contaminant emissions represent a significant contribution to the human health and freshwater ecotoxicity impact in case the toxicity of the emerging contaminant load is average to high, i.e. between the median and the 3<sup>rd</sup> quartile of organic substances CFs in USEtox. This confirms the relevance of using a emerging contaminant removal system to protect freshwater ecosystems in rivers and lakes that receive the effluent. Concerning background toxicity, membrane production of ceramic membranes has minor impacts while polymeric membrane production has a larger impact because of the toxic solvent NMP that is used.

**Significant impacts due to powdered activated carbon:** To realise these substantial benefits the required technologies produce significant impacts in terms of global warming potential (GWP), mainly due to emissions from powdered activated carbon (PAC) production and increased electricity demand for membrane aeration. Depending on the PAC production assumed, the GWP increases by a

factor 2 compared to the current WWTP’s impacts. It also increases the impact of other energy related impact categories such as cumulative energy demand, terrestrial acidification potential and particulate matter formation. Previous studies have also pointed out the importance of the PAC production on the overall environmental assessment and the lack of specific production data (Larsen et al. 2010; Abegglen and Siegrist 2012a). The impact of PAC may be lower if regenerative raw materials rather than hard coal is used. To keep the emerging contaminant removal benefits and minimize the trade-offs related to energy requirement for PAC production and membrane aeration, it is advisable to minimize required PAC dosing by utilizing its maximum adsorption capacity, reduce aeration requirements by advanced aeration techniques such optimization through intermittent aeration or the use of non-aerated pressurized membrane systems and switching to efficiently produced activated carbon from renewable raw materials.

Table 4-4: Summary of LCA (net impact) and LCC results for Birsfelden case study

	Ceramic membrane	Polymeric membrane
<b>Improvements in local water quality</b>		
Changes in freshwater eutrophication [kg P-eq/m <sup>3</sup> ]	3.52E-04	3.54E-04
Changes in ecotoxicity (freshwater) [CTUe/m <sup>3</sup> ]	1.84E-01	2.00E-01
Change in human toxicity, cancer effect [CTUh/m <sup>3</sup> ]	1.52E-08	1.66E-08
Change in human toxicity, non-cancer effect [CTUh/m <sup>3</sup> ]	5.36E-10	5.70E-10
<b>Environmental impacts of construction and operation</b>		
Carbon footprint [kg CO <sub>2</sub> -eq/m <sup>3</sup> ]	3.53E-01	3.72E-01
Energy demand (fossil) [MJ/m <sup>3</sup> ]	1.33E+00	1.36E+00
<b>Life Cycle Costs</b>		
Investment cost [€/m <sup>3</sup> infiltrated/yr.]	1,74	1,21
Operational cost [€/m <sup>3</sup> infiltrated]	0,08	0,09
Total discounted life cycle cost over 30 years [€/m <sup>3</sup> treated]	0,14	0,14

**Some additional benefits of hybrid membrane systems not accounted for in LCA:** While discussing environmental benefits of ceramic and polymeric membranes, an important limitation of this study is

that additional benefits such as complete disinfection of secondary effluent by mechanical removal of bacteria and viruses are not accounted for in the current LCA methodology. Compared to oxidative processes for emerging contaminants removal (e.g. ozonation), the hybrid PAC/membrane system does not form potentially dangerous degradation products and also provides full particle removal which are also not assessed in this LCA.

**Limitations of the LCA methodology:** Since wide-spread research on emerging contaminants is relatively new, there are still major information gaps which have to be filled in the years to come. This includes calculation of more LCA characterization factors for detailed quantification of substance toxicities based on chronic exposure studies and in-depth understanding of substance interactions and by-products. Secondary environmental benefits like disinfection by bacteria and virus removal and microparticle sequestration shall also be quantified in current LCA methodologies.

#### 4.4 CS2.2: ANCS in drinking water treatment

##### 4.4.1 Case study description

The main task of WAG (*Wassergewinnungs- und -Aufbereitungsgesellschaft Nordeifel*) is drinking water supply for about 500'000 inhabitants in the Aachen area. Furthermore, WAG is also providing drinking water for distribution by the Dutch water supplier WML. For these tasks, WAG is running and maintaining four drinking water reservoirs in the northern part of the Eifel mountain range. Two water works for treatment of the raw water produce about 33 million m<sup>3</sup> of drinking water per year. The larger of these two water works, the Roetgen plant, was constructed in 1953 with removal of particles, iron and manganese as main features of the treatment process. In 1995 it was decided to expand this water works in order to ensure highest quality standards also for periods of decreased raw water quality. The company initiated the implementation of one of the world's first and largest full-scale membrane treatment plants for drinking water production.

Hence, WAG is operating a two-stage ultrafiltration (UF) plant for drinking water production and backwash water treatment. Permeate of the backwash water treatment is recycled back to the raw water line of the drinking water process. For some reasons, the recovery of the drinking water line is lower than expected. Ambitions of WAG are to improve performance of the secondary treatment step in order to reach an intended total recovery of about 99% for the entire drinking water plant.

##### 4.4.1.1 Existing system at full-scale

WAG operates a two-stage UF (7'000 m<sup>3</sup>/h) for drinking water production (Figure 4-14, left panel) and backwash water treatment (Figure 4-14, right panel). It turned out that the specific recovery of the drinking water line (ratio of filtrate vs. feed flow) is lower than expected, resulting in more backwash water to be treated. In this context, the purpose of ANCS is to increase the performance of the existing plant by process optimization. Therefore in WP23 an UF pilot with ANCS control will be operated in parallel to the corresponding full-scale UF stage of backwash water treatment, and the combined pilot system will be operated and optimized in parallel to the large-scale operation. Based on pilot results, the new process control system based on automatic neural networks may be integrated in an existing membrane treatment system in order to optimize the process performance at full-scale.

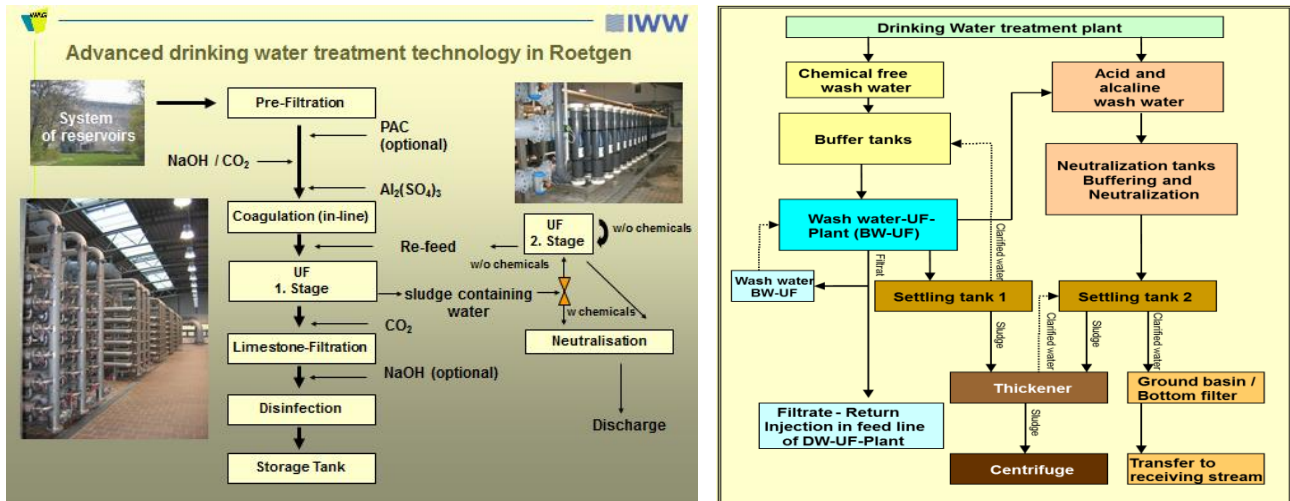

Figure 4-14: Principle diagram of drinking water treatment (left panel) and backwash water treatment process design (right panel), both at WAG Roetgen

Within DEMEAU WP23, partners analysed the performance and advantage of an Automatic Neural net Control System (ANCS, see Figure 4-15) for controlling an UF process in terms of

- taking into account process parameters measured online,
- learning about impacts/relations of important parameters on membrane fouling,
- optimizing the UF process by adjusting flux rate, filtration time and chemical cleaning frequency, thus minimizing the future development of fouling and decreasing costs for operation

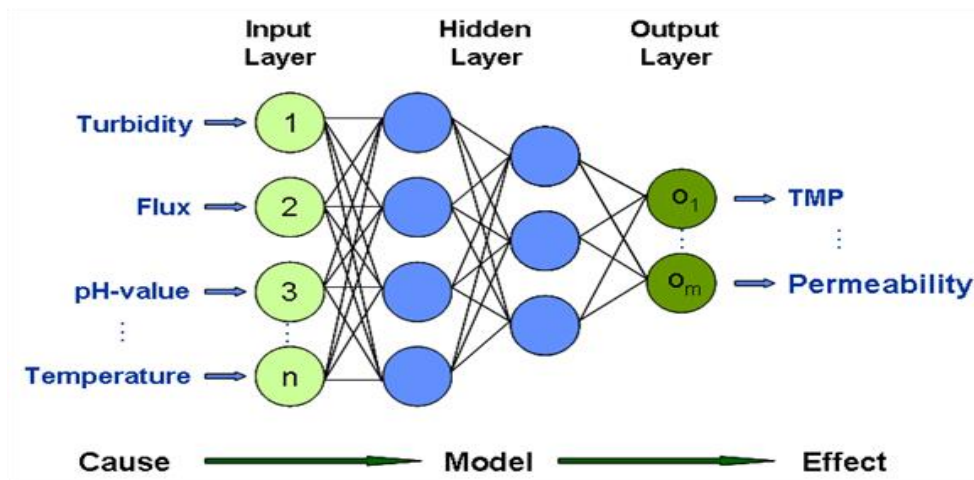

Figure 4-15: Training and working scheme of ANCS

**Key figures:**

Production capacity at WAG Roetgen:

Drinking water treatment 26 Mio m<sup>3</sup>/yr.

Backwash water treatment 4.3 Mio m<sup>3</sup>/yr.

ANCS was operated in the backwash water treatment process; the main-line drinking water treatment process was not subject of the case study. The pilot plant was tested parallel to the technical plant with original backwash-water at WAG. The training of the ANN was done by aquatune and IWW. In order to get a high number of different raw-water conditions the pilot plant was operated for at least one year. After training of the neural net, ANCS was adjusted with the automatic functions in order to be able to control the pilot plant automatically.



Figure 4-16: UF pilot with two independent treatment lines

#### 4.4.2 LCA and LCC: Definition of goals and scope

##### 4.4.2.1 Definition of goals

The goal of LCA and LCC analysis within DEMEAU is to quantify the potential savings of ANCS operation for the full-scale backwash water UF plant at WAG Roetgen by comparing ANCS-based operation with the status quo situation as reference. These savings with ANCS are expected to occur in energy demand for UF operation (electricity) and chemical demand for membrane cleaning (acid, caustic), extrapolating from pilot data to the full-scale plant. For these effects, LCA will characterize decreased environmental impacts due to reduced energy and chemicals consumption, while LCC will



elaborate on the economic feasibility of investing in an ANCS system and the expected pay-back time of ANCS.

4.4.2.2 System boundaries and investigated systems

The system boundaries include the entire process of backwash water treatment, beginning with the incoming backwash flow from the drinking water treatment plant as input volume (Figure 4-17). The backwash water is then treated by a UF membrane (inside-out Multibore® system) that is operated in dead-end mode and has to be cleaned by regular backwash. In regular intervals, chemical enhanced backwashing (CEB) with acid and caustic is used to prevent organic and inorganic fouling of the membranes. The produced concentrate with high solids content is further treated with thickening and dewatering prior to final disposal of residual sludge in a landfill. Output water flows are the filtrate of the UF membrane, which is pumped back to the main drinking water process as feed water (= no emissions to the environment), and the excess water from thickening and dewatering of concentrate, which is discharged to surface waters (= direct water emissions).

Background processes considered in the LCA and LCC case study are production of electricity, chemicals and building materials for construction (infrastructure) of UF membrane and ANCS control panel.

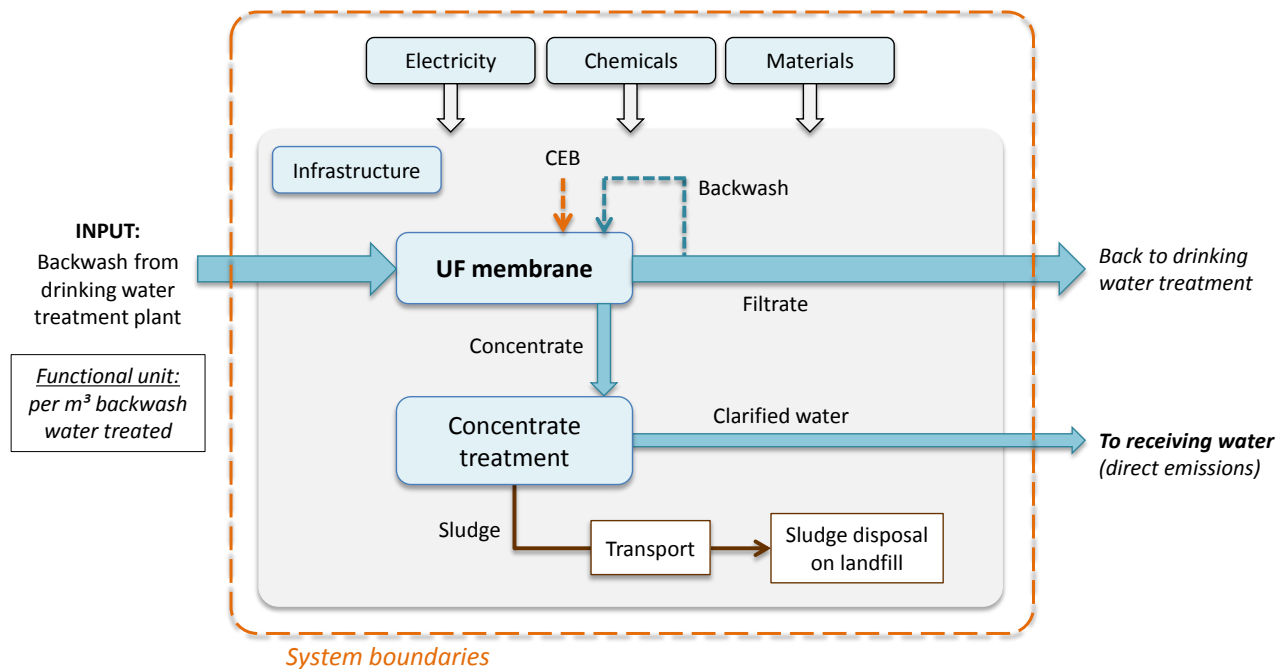

CEB = Chemical enhanced backwash

Figure 4-17: System boundaries of LCA/LCC study for ANCS at WAG Roetgen

Based on first results of the pilot trials, two different scenarios for ANCS operation have been defined (conservative estimate and potential estimate of ANCS effects). Hence, the following three scenarios are analyzed in this case study (Figure 4-18):

1) Status quo (2014):

Backwash water treatment by UF membranes (BW-UF) is characterized with electricity and chemical demand, using reference data of the year 2014. Processes included within this scenario

are regular backwashing, chemically enhanced backwash (CEB), thickening and dewatering of concentrate (simplified model) as well as transport and final disposal of sludge.

2) ANCS (conservative):

Based on scenario “status quo 2014”, total savings in electricity demand by -17% for UF membrane operation are assumed due to implementation of ANCS control. This assumption is considered as a conservative approach based on results of ANCS pilot plant. Savings of electricity demand are related to the feed pump and the backwash pump of UF membrane process, whereas electricity demand for concentrate treatment is considered as constant.

3) ANCS (potential):

Based on scenario “status quo 2014”, this scenario describes potential savings in electricity and chemical demand which may be realized in full-scale UF membrane operation with ANCS. Best estimates assume a reduction of -27% in electricity demand for the filtration and the backwash cycle and -30% in chemical demand for CEB (sodium hydroxide and sulfuric acid). No changes in demand for concentrate treatment (coagulant & flocculants) are assumed.

1) Status quo 2014

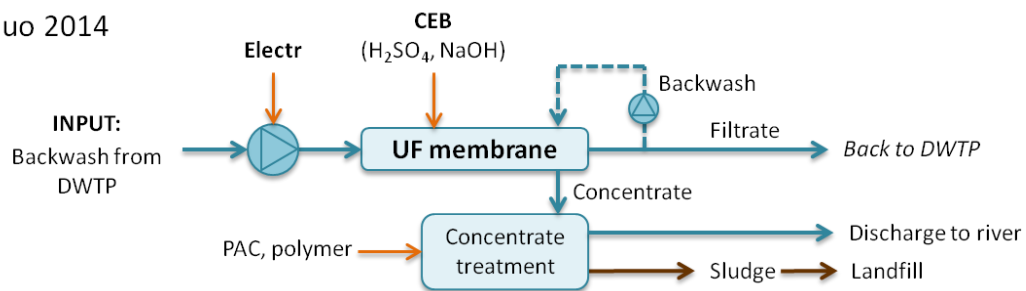

2) ANCS conservative

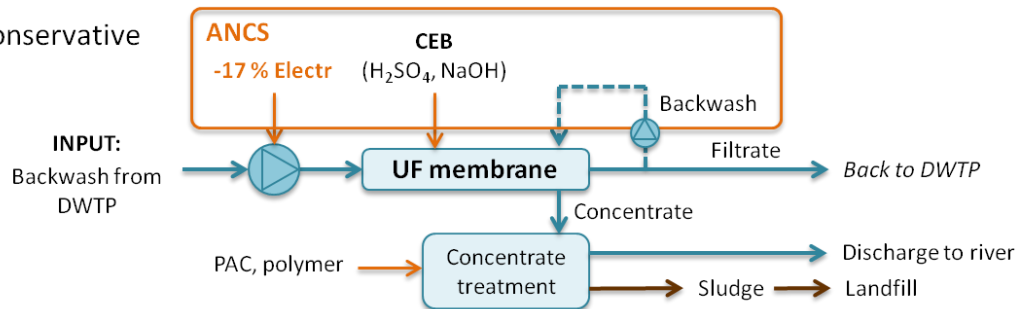

3) ANCS potential

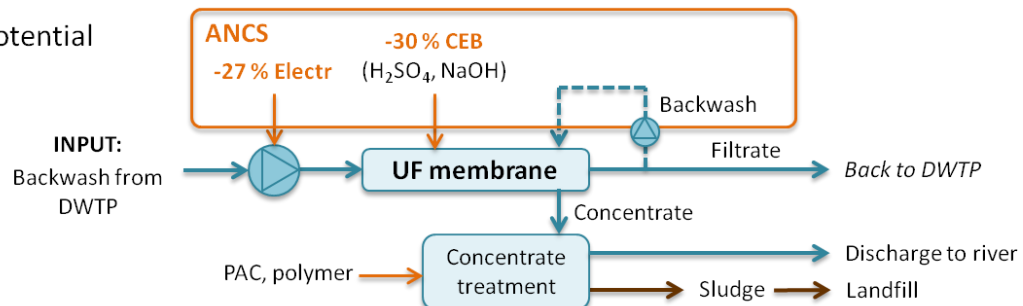

Figure 4-18: Scenarios for LCA and LCC for implementation of ANCS at backwash water treatment in WAG Roetgen

4.4.2.3 Functional unit

The function of the investigated process is the treatment of the produced backwash water from the main drinking water treatment plant by the UF membrane. Hence, the functional unit for the LCA and LCC is defined as: Per volume of incoming backwash water per  $m^3_{Q_{in}}$ . For all scenarios the input backwash water volume coming from the main drinking water treatment process is defined with a constant annual water volume of 4'300'000  $m^3$ .

4.4.2.4 Life Cycle Inventory for LCA

Data for backwash water treatment through BW-UF membrane were provided by the operator of the drinking water treatment plant WAG Roetgen. The data describes the annual average of energy and chemical demand in the year 2014 (Figure 4-19).

An input volume of 4.3 million  $m^3$ /yr. of backwash water is treated by the BW-UF membrane. Feed pumps of the BW-UF plant require a specific energy demand of 116  $Wh/m^3$  (= 500 MWh/yr.). 10 % of annual input volume (= 430'000  $m^3$ /yr.) is needed for backwashing the BW-UF membrane, requiring an energy demand of 14  $Wh/m^3$  feed water (60 MWh/yr.) for backwash pumps. Water for backwash process is drawn from the filtrate, which results in 3.87 million  $m^3$ /yr. of filtrate going back to the main drinking water treatment process. For chemically enhanced backwash (CEB) taking place with an average frequency of 1/day, an annual chemical demand of 207 t/yr. NaOH (25%) and 37 t/yr.  $H_2SO_4$  (38%) is needed.

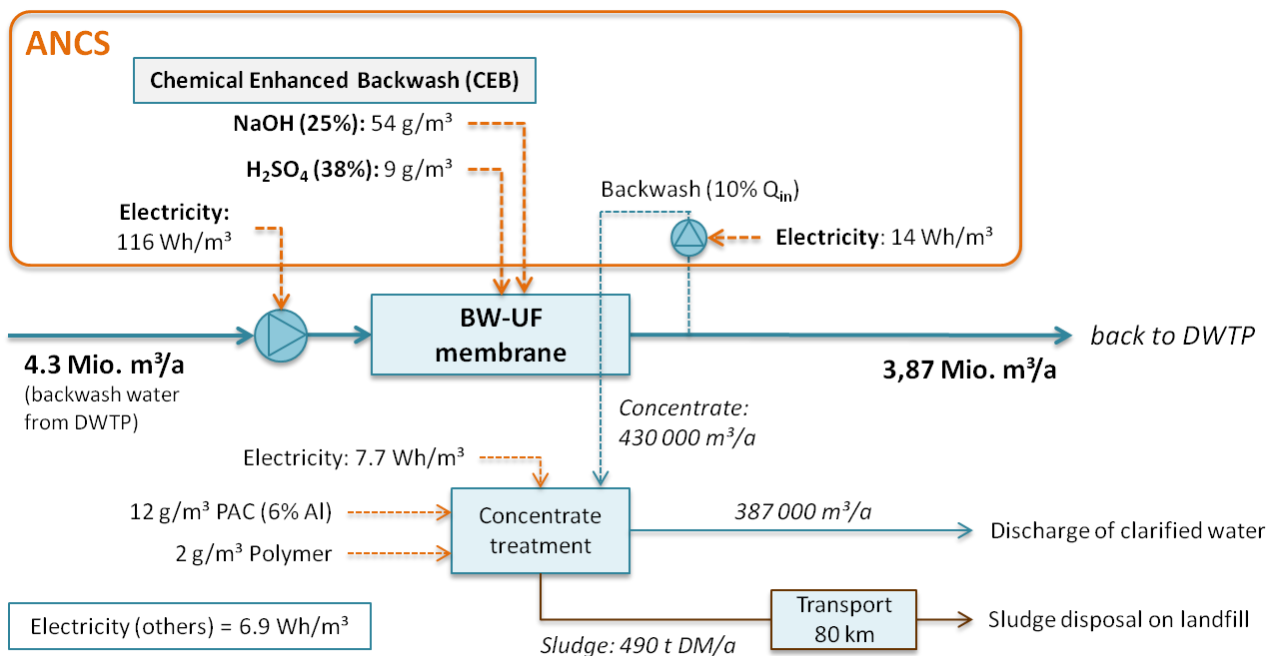

Figures given referring to 1  $m^3$  backwash water treated = Input flow

Figure 4-19: Life cycle inventory of backwash water treatment at WAG Roetgen (data from: status quo 2014)

Concentrate from BW-UF membrane is further treated with coagulant polyaluminium chloride (Gilufloc 40.5 t/yr. of PAC, 6% Al content) and polymer (Ferrocryl 8'709 t/yr.) for thickening and dewatering. Excess water is discharged into surface water (387'000  $m^3$ /yr.), and water quality of this effluent is considered similar to drinking water quality (Enwor 2015). The produced sludge (490 t dry

matter (DM)/yr., 80% DM) is transported to an inert material landfill in Hürth, close to Cologne (= 80 km transport distance). Electricity demand for concentrate treatment is estimated to 33 MWh/yr., while auxiliary demand for all other aggregates is estimated to 29.65 MWh/yr. Although some target functions of the ANCS contain terms that describe the productivity, which directly influences the amount of produced concentrate, the concentrate treatment is assumed to be constant for all scenarios due to missing data, which, of course, is a limiting factor to the accuracy of the final results.

In the conservative ANCS scenario, 17% of electricity for feed and backwash pumps (= 85 MWh/yr.) can be saved for BW-UF operation, resulting in a remaining electricity demand of 415 MWh/yr. for this stage. For the potential ANCS scenario, 27% of electricity for feed and backwash pumps (= 135 MWh/yr.) can be saved with ANCS, together with an estimated savings of 30% of NaOH (= 62.1 t/yr.) and H<sub>2</sub>SO<sub>4</sub> (= 11.1 t/yr.) for reduced frequency of CEB (Table 4-5). For infrastructure, a simplified inventory is defined based on previous studies for membrane processes (Remy 2013), assuming Multibore® UF membranes (Inge dizzer XL 0.9 MB 60) and T-Racks. Material demand is listed in Table 4-6 for 210 UF modules including T-Racks. Lifetime for membranes is estimated to 8 years, while lifetime for T-Racks is assumed with 20 years. Background datasets for electricity, chemicals and materials from ecoinvent v2.2 database are displayed in Table 4-7. The electricity mix in Germany at medium voltage level is modelled with “electricity, medium voltage, at grid [DE]”, which represents the electricity production in Germany from 2008. Polyaluminiumchloride (PAC) as coagulant is modelled according to Remy 2013 with aluminiumhydroxide and hydrochloric acid as basic chemicals, and polyacrylamide as polymer is modelled with basic chemical acrylonitrile for acrylamide production.

Table 4-5: Life cycle inventory for different scenarios without and with ANCS system

	Unit	Status quo (2014)	ANCS (conservative)	ANCS (potential)
<b>Mass balances (water, sludge)</b>				
Inflow ( $Q_{in}$ )	$m^3/yr.$	4'300'000	4'300'000	4'300'000
Backwash volume	% $Q_{in}$	10	10	10
	$m^3/yr.$	430'000	430'000	430'000
Discharge to river <sup>1</sup>	$m^3/yr.$	387'000	387'000	387'000
Sludge volume	$t DM/yr.$	490	490	490
Dry matter (DM) content of sludge	% DM	80	80	80
Transport distance to sludge disposal	km	80	80	80
<b>Energy and chemical demand</b>				
Electricity for feed pump	$Wh/m^3_{Q_{in}}$	116	96.3	84.7
Electricity for backwash pump	$Wh/m^3_{Q_{in}}$	14	11.6	10.2
NaOH (25 %)	$g/m^3_{Q_{in}}$	48	48	33.7
H <sub>2</sub> SO <sub>4</sub> (38 %)	$g/m^3_{Q_{in}}$	8.6	8.6	6
Electricity for concentrate treatment	$Wh/m^3_{Q_{in}}$	7.7	7.7	7.7
Poyaluminiumchloride (6 % Al)	$g/m^3_{Q_{in}}$	11.4	11.4	11.4
Polymer (100%)	$g/m^3_{Q_{in}}$	1.9	1.9	1.9
Electricity demand (others)	$Wh/m^3_{BW}$	6.9	6.9	6.9

<sup>1</sup> quality assumed comparable to drinking water

Table 4-6: Material demand for 210 UF membrane modules

Material	ecoinvent v2.2 dataset	Amount	Unit	Lifetime
<b>HD-PE for PES</b>	polyethylene, HDPE, granulate, at plant [RER] & extrusion, plastic pipes [RER]	1'576	kg	8 yr.
<b>Epoxy resin</b>	epoxy resin, liquid, at plant [RER]	880	kg	8 yr.
<b>PVC-U</b>	polyvinylchloride, at regional storage [RER] & extrusion, plastic pipes [RER]	3'276 1'722	kg	8 yr. 20 yr.
<b>PP</b>	polypropylene, granulate, at plant [RER] & extrusion, plastic pipes [RER]	168	kg	20 yr.
<b>stainless steel</b>	chromium steel 18/8, at plant [RER]	720	kg	20 yr.
<b>Electricity</b>	electricity, medium voltage, at grid [DE]	18.9	MWh	8 yr.
<b>Light fuel oil</b>	light fuel oil, burned in industrial furnace 1MW, non-modulating [RER]	128	GJ	8 yr.

[RER] = Region of production: Europe, [CH] = Production in Switzerland, [DE] = Production in Germany

Table 4-7: Materials used from ecoinvent v2.2 for modelling chemicals and electricity in operation phase

material	ecoinvent v2.2 dataset	remarks
<b>Electricity mix in Germany at medium voltage</b>	electricity, medium voltage, at grid [DE]	-
<b>Sodium hydroxide (NaOH, 25%)</b>	sodium hydroxide, 50% in H2O, production mix, at plant [RER]	
<b>Sulfuric acid (H<sub>2</sub>SO<sub>4</sub>, 38%)</b>	sulphuric acid, liquid, at plant [RER]	
<b>Polyaluminiumchloride (PAC, 6% Al)</b>	aluminium hydroxide, at plant [RER] electricity, medium voltage, at grid [DE], hydrochloric acid, 30% in H2O, at plant [RER]	Remy 2013
<b>Polymer (100% polyacrylamide)</b>	acrylonitrile from Sohio process, at plant [RER] + tap water, at user [RER]	1 kg polyacrylamide = 0,75 kg acrylonitrile + 0,25 kg water (Remy 2013)

#### 4.4.2.5 Life Cycle Inventory for LCC

Input data for the backwash water treatment process were provided by the operator of the drinking water treatment plant, WAG Roetgen. It includes all costs for buildings, membranes, piping, pumps, measuring instruments, electronics and engineering, required for the current backwash water treatment process of the drinking water plant in Roetgen, based on the initial investment costs capitalized by WAG. In total, these costs are calculated to be about 5.3 Mio. EUR.

The costs for ANCS were submitted by the provider of ANCS technology, aquatune, itself. According to this information two major financing options, regularly offered by aquatune, were investigated within life cycle costing: project financing and contracting. For both of these financing modes three cost categories have to be distinguished: hardware, software licenses and other costs (consulting, expertise, implementation, etc.). With project financing, ANCS implementation can be performed by a single payment of app. 155'000 EUR (for a plant sized as the Roetgen plant!). In contrast, using the contracting approach, the customer has to pay the same software license and hardware costs as with project financing as a single payment, whereas the costs of consultancy will be due in relation to the amount of annual costs savings in electricity and chemicals. In this example, the share of cost savings that has to be paid for ANCS is assumed to be about 30%.

Table 4-8: Cost inventory for different scenarios of ANCS

	Unit	Status quo (2014)	ANCS (conservative) -project-	ANCS (potential) -project-	ANCS (conservative) -contracting-	ANCS (potential) -contracting -
<b>Capital expenditure</b>						
Initial Investment	k€	5'285	5'285	5'285	5'285	5'285
ANCS	k€	-	155	155	60	66
hardware	k€	-	5	5	5	5
software	k€	-	50	50	50	50
other	k€ or k€/yr.	-	100	100	5 (p. a.)	11 (p.a.)
<b>Operational expenditure</b>						
energy	k€/yr.	104	88	78	88	78
operating supplies	k€/yr.	100	100	89	100	89
other	k€/yr.	540	540	540	540	540

Lifetime of investment is estimated for buildings (50 yrs.), racks, piping & electronics (30 yrs.), fittings (20 yrs.), pumps and batchers (15 yrs.) and measuring instruments (10 yrs.). Equipment required for ANCS is initially assumed to have an endless lifetime in order to find the break-even-point in time for the amortization of the investment. Nevertheless, it should be mentioned that according to literature the lifetime of hardware and software components is expected to be max. 10 yrs. (Anonymus 2012).

### 4.4.3 Results and discussion

#### 4.4.3.1 LCA impact assessment

#### Total environmental impacts for all scenarios

The environmental profiles of the three scenarios are described with a set of 10 indicators (Figure 4-20). In all indicators, reduction in electricity and chemicals demand due to implementation of the ANCS system will reduce the environmental impact of the BW-UF plant.

The main contribution to the total environmental impact for the BW-UF construction and operation originates from the electricity demand for process operation, which is responsible for the majority of indirect impacts: 70% of fossil energy demand, 80% of nuclear energy demand, and 75% of global warming potential. Chemical demand is responsible for another 15-18% in these impact categories, followed by sludge treatment and disposal. The contribution of infrastructure is negligible (<5%) in all impact categories due to the long lifetime of the components.

Chemicals production is more important in selected impact categories such as acidification, particulate matter formation, or human toxicity potential, most probably due to direct process emissions during chemical production. Direct water emissions are responsible for a major share of life-cycle emissions for marine eutrophication (nitrogen emissions to surface waters) and also ecotoxicity potential. However, ANCS implementation does not affect direct emissions of BW-UF plant to surface waters in this study.

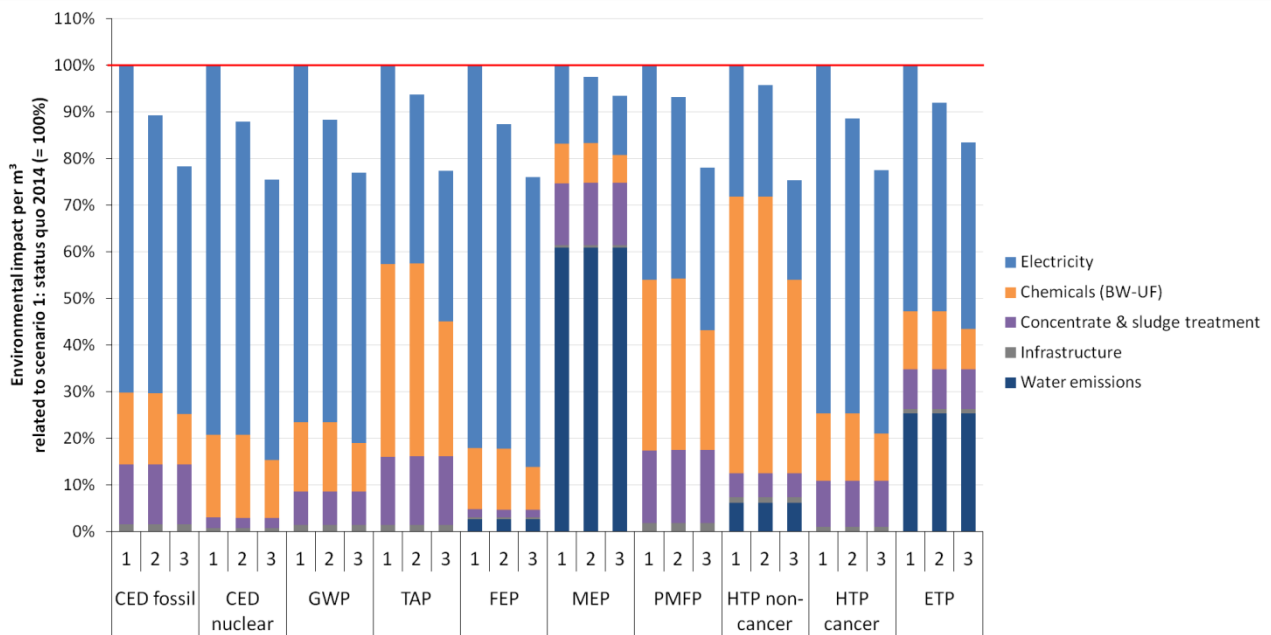

Figure 4-20: Environmental profiles of scenarios (1: status quo (2014), 2: ANCS (conservative), 3: ANCS (potential)) related to max scenario = 100 %

Overall, ANCS implementation can substantially reduce the main environmental impact of BW-UF plant by reducing major contributors to resource demand and related greenhouse gas emissions, namely electricity for feed and backwash pumps and chemicals for CEB. The environmental profile shows that these effects can be decreased with ANCS implementation, saving on energy resources and related CO<sub>2</sub> emissions. This impact on indirect emissions on the life-cycle is further discussed in detail below.

### Effect of ANCS implementation on fossil energy demand and greenhouse gas emissions

Focusing on fossil energy demand ( $CE_{fossil}$ ), electricity demand for UF operation contributes 56 % ( $= 0.86 \text{ MJ/m}^3_{Q_{in}}$ ) of total  $CE_{fossil}$  ( $1.53 \text{ MJ/m}^3_{Q_{in}}$ ) in the reference scenario (Figure 4-21). In addition, chemical demand for CEB contributes  $0.22 \text{ MJ/m}^3_{Q_{in}}$  for NaOH (14%) and  $0.013 \text{ MJ/m}^3_{Q_{in}}$  for  $H_2SO_4$  (<1%). Consequently, savings in electricity demand at UF operation with ANCS lead to a substantial decrease in  $CE_{fossil}$  to  $1.37 \text{ MJ/m}^3_{Q_{in}}$  (-11%) for ANCS (conservative) or  $1.2 \text{ MJ/m}^3_{Q_{in}}$  (-22%) for ANCS (potential). All other processes causing fossil energy demand (electricity for backwash, sludge treatment and disposal, infrastructure) are not affected by ANCS implementation.

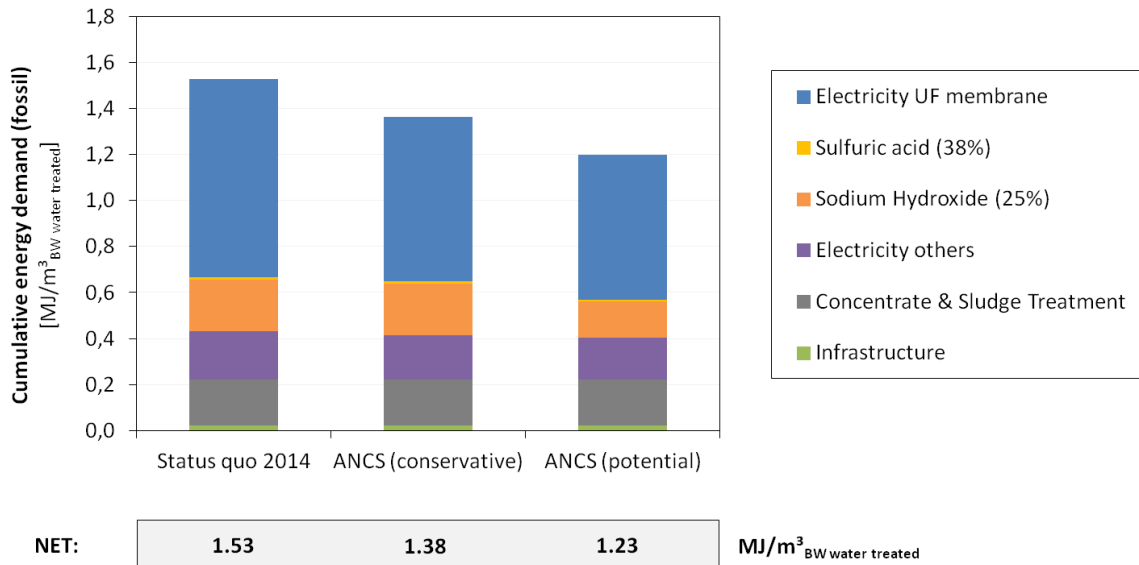

Figure 4-21: Cumulative energy demand (fossil) of scenarios for BW-UF plant at Roetgen

The impacts on global warming potential (GWP) correlate closely to fossil energy demand, since there are no direct greenhouse gas emissions in the process and hence only indirect emissions are contributing to GWP. Baskwash water treatment in the reference scenario is associated with  $124 \text{ g CO}_2\text{-eq/m}^3_{Q_{in}}$  in GWP, relating to  $533 \text{ t CO}_2\text{-eq/yr.}$  for the entire BW-UF plant (Figure 4-22). For the ANCS (conservative) scenario, savings in electricity lead to a -12% decrease in GWP ( $= -15 \text{ g CO}_2\text{-eq/m}^3_{Q_{in}}$ ), whereas the ANCS (potential) scenario decreases GWP by -23 % ( $= -29 \text{ g CO}_2\text{-eq/m}^3_{Q_{in}}$ ). For the entire BW-UF plant at Roetgen, the total savings in GWP due to ANCS optimisation amount to 62-123 t  $\text{CO}_2\text{-eq/yr.}$  based on the results of this LCA.



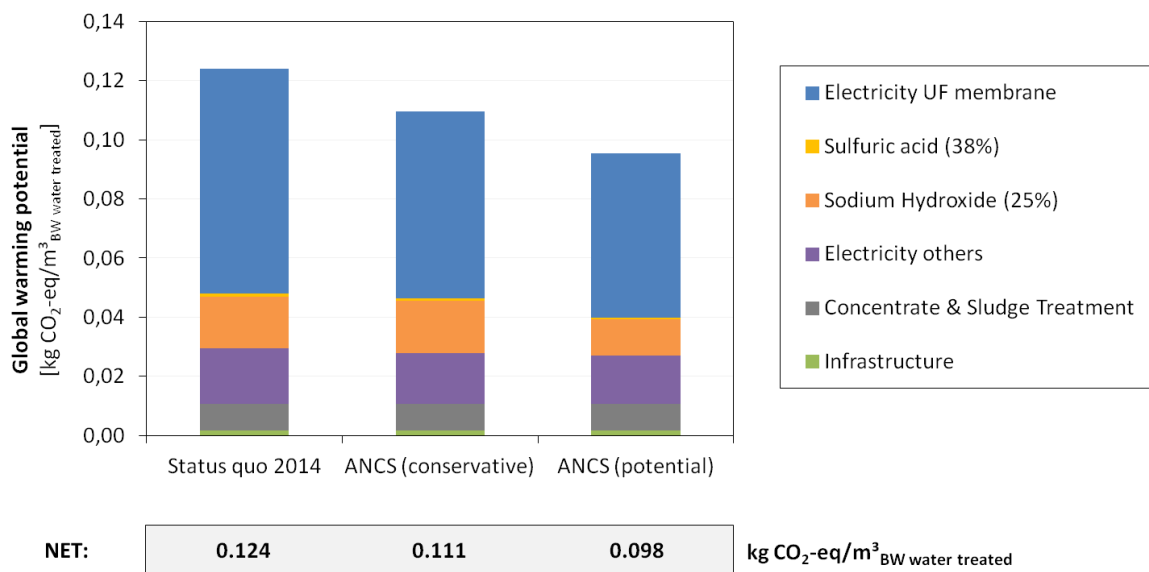

Figure 4-22: Global warming potential (100 years) of scenarios for BW-UF plant at Roetgen

#### 4.4.3.2 LCC assessment

To account for the costs of an ANCS implementation for the backwash water treatment process at Roetgen using two different financing modes (project financing and contracting), capital expenditure (CAPEX) and operational expenditure (OPEX) of the five resulting scenarios (status quo w/o ANCS, conservative-project, conservative-contracting, potential-project, potential-contracting) were collected. Each of the sums (CAPEX, OPEX) was aggregated and will now be presented as an absolute sum or in reference to the system’s capacity or volume of incoming backwash water [EUR/ $\text{m}^3_{\text{Qin}}$  or EUR/( $\text{m}^3_{\text{Qin}}/\text{yr.}$ )].

#### Capital costs for infrastructure

The initial investment costs of the backwash water treatment, including all construction costs for buildings, membranes, piping, pumps, measuring instruments, electronics and engineering, required for a system sized as the one at the drinking water plant in Roetgen, is calculated to be about 1.37 EUR/( $\text{m}^3_{\text{Qin}}/\text{yr.}$ ) (5.3 Mio. EUR in total). The largest fractions of these costs are due to buildings (39 %), the membrane system (21 %), electronics (13 %) and piping (13%) in our case. In comparison to this, the additional investment costs of the ANCS-system are quite low. They range between 0.04 EUR/( $\text{m}^3_{\text{Qin}}/\text{yr.}$ ) with project financing used and 0.01 EUR/( $\text{m}^3_{\text{Qin}}/\text{yr.}$ ) under a contracting approach. This means, in relation to the initial investment costs of the plant, only 1–3 % of the whole investment costs are caused by ANCS (Figure 4-23).

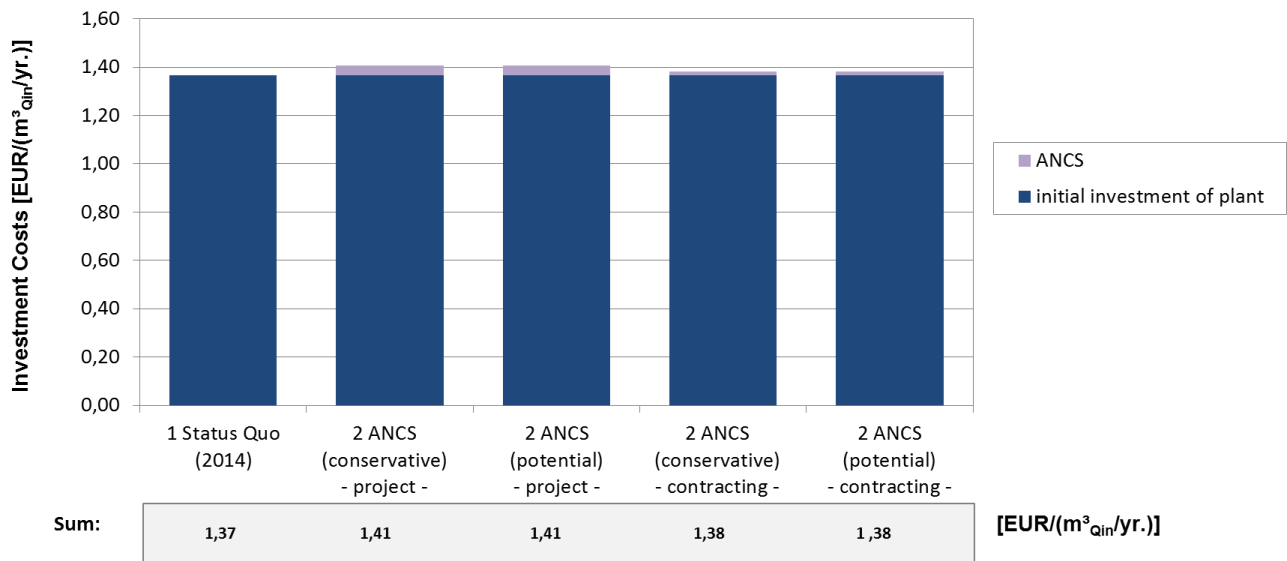

Figure 4-23: CAPEX per system capacity of scenarios for BW-UF plant at Roetgen

### Operational costs

The system’s operational expenditure can be divided in six different cost types: electricity, chemicals, waste disposal, personnel, expertise/consultancy, and capital services. As electricity and chemical costs are the only costs influenced by ANCS, these cost types will be described separately whereas the remaining operational costs will only be presented in total.

Without ANCS implemented, electricity costs are about 0.03 EUR/m<sup>3</sup><sub>Qin</sub> which is 14 % of the total operating costs (0.19 EUR/m<sup>3</sup><sub>Qin</sub>), chemicals costs are in the same range (0.03 EUR/m<sup>3</sup><sub>Qin</sub> or 13% of total OPEX). The cost savings caused by the ANCS system are assumed between 16’000 and 36’000 EUR/year. Thereof up to 11’000 EUR/yr. are the result of a decreased used of chemicals and 15.000 – 25.000 € are caused by a lower electrical demand. In total, ANCS can therefore lead to reduction of operational costs up to 0.01 EUR/m<sup>3</sup><sub>Qin</sub> (Figure 4-24).

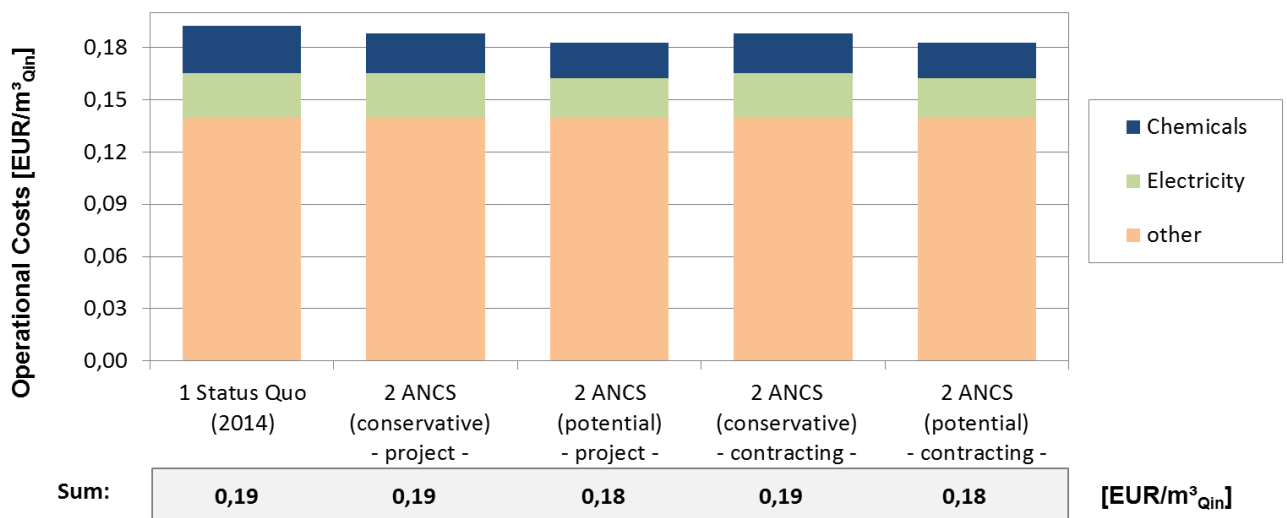

Figure 4-24: OPEX per m<sup>3</sup> of incoming backwash water of scenarios for BW-UF plant at Roetgen

### Net present value over the life cycle

Although the absolute reduction of operational costs induced by ANCS seems to be quite low, the overall net present values over a system’s life cycle of 30 years proves that ANCS can lower the overall costs of backwash water treatment by about 1-3 % (0.2 – 0.6 Mio EUR). Under conservative estimation of energy savings the reductions is about 0.16-0.23 Mio EUR (< 0.01 EUR/m<sup>3</sup> Q<sub>in</sub>) in total. If ANCS realizes its full potential, the decrease of NPV will be slightly higher 0.44-0.56 Mio EUR (< 0.01 EUR/m<sup>3</sup> Q<sub>in</sub>) (Figure 4-25).

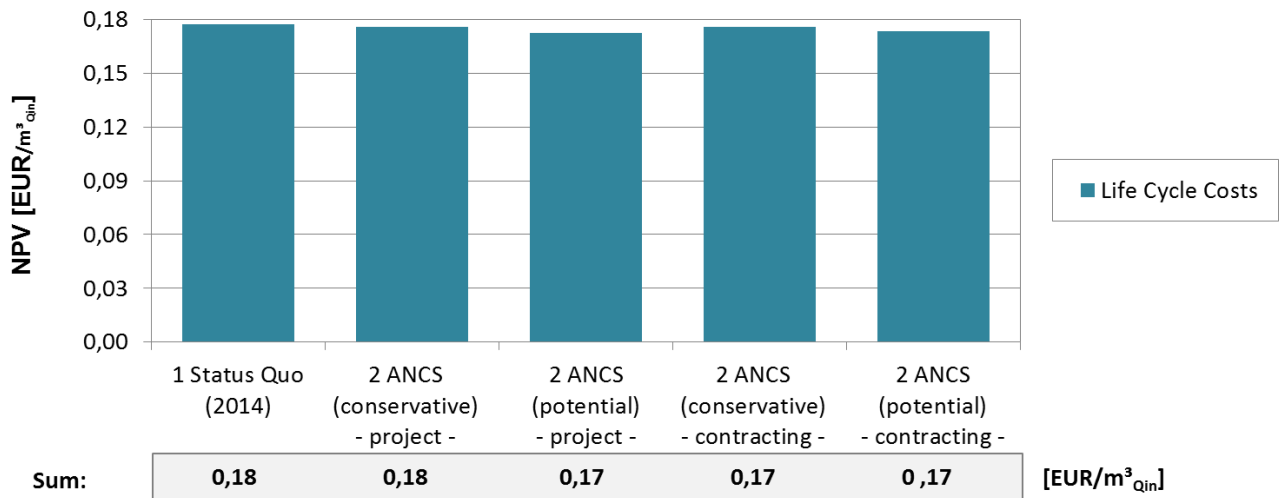

Figure 4-25: Net present value (NPV) per m<sup>3</sup> of incoming backwash water of scenarios for BW-UF plant at Roetgen over a course of 30 years

However, these results should be regarded with caution because, as initially mentioned, within these calculations the lifetime of the ANCS is assumed to be eternal. In order to decide on the profitability of the ANCS a break-even analysis is required. This will be performed in the following section.

### Break-even analysis on ANCS investment

In order to decide on the profitability of the ANCS system, investment costs of the ANCS have to be offset to the annual savings in chemicals and electricity. Figure 4-26 and Figure 4-27 describe this by showing the change in net present value for each of thirty years regarded as annual total difference to the status quo system in that year. In the first years after the ANCS investment this difference is negative due to the fact that an initial investment has to be done for the procurement of the ANCS software, hardware and consultancy. Year by year this negative difference is reduced by the cost savings that are realized in reference to the status quo system until, at some point in time, the cost difference turns positive. This is the point in time when the ANCS investment has amortized, the break-even-point of costs and savings (BEP 1, BEP 2) .

With conservative estimation of energy savings and contracting (Figure 4-26), costs of the ANCS system amortize in app. 6 years (BEP 1). If the investment is financed as a project, a positive NPV value is reached after 12 years (BEP 2) which exceeds the expected lifetime of the ANCS’ hardware and software (max. 10 years). Following this, under the assumptions made, ANCS will only be profitable if contracting is used as a financing approach.

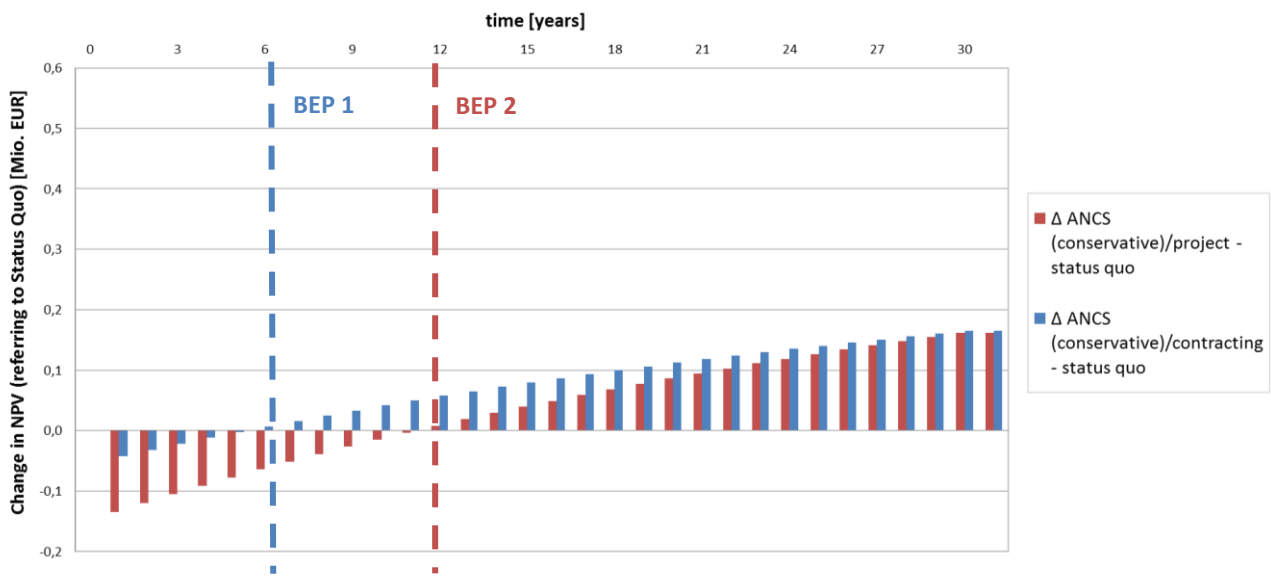

Figure 4-26: Change in net present value (NPV) (referring to *status quo*) of ‘conservative’ ANCS scenarios in Roetgen with break-even-points BEP1 and BEP2

However, if the potential estimations of energy and chemicals will be reached (Figure 4-27), the ANCS investment amortizes with contracting in a few years (BEP 1). Project-financed this effect occurs clearly later (app. 5 years (BEP 2)) but, in the end, the revenue after 30 years will be higher (app. 0,1 Mio. EUR) than with contracting. Hence, ANCS is profitable in either way as long as the potential savings are reached.

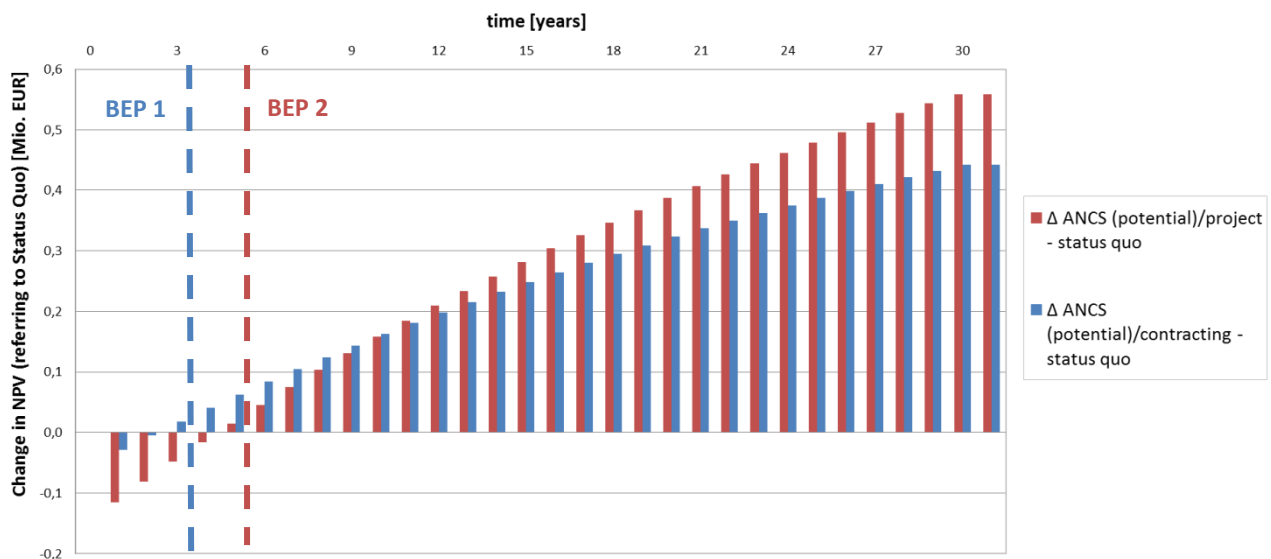

Figure 4-27: Change in net present value (NPV) (referring to *status quo*) of ‘potential’ ANCS scenarios in Roetgen with break-even-points BEP1 and BEP2

The results of this analysis show that the profitability of ANCS is strongly depending on the financing mode used and the chemicals and energy savings that are realized. In our calculations for example, under conservative estimation of saving and with these amounts investment costs assumed, ANCS is just profitable if investment is financed by contracting. If the potential estimation of energy and chemicals savings is reached, the additional control system is profitable in any case.

Nevertheless, it is necessary to highlight that these results are only valid for this special case and with the corresponding assumptions made. In practice, the investment costs of ANCS have to be calculated case-by-case and, according to aquatune, the financing mode will be customized then in accordance with the estimated cost savings to be realized at the plant.

4.4.3.3 Summary of LCA/LCC results

A summary of LCA and LCC results is provided below (Table 4-9). Results of the life cycle assessment prove that, ANCS improves cumulative energy demand and carbon footprint of the whole treatment plant (10-20% less fossil fuel demand, 10-21% less GHG emissions) by enabling savings in energy and chemicals.

Although investment costs are very low (1–3 %) in comparison to the initial investment of the whole backwash water treatment facilities, ANCS implementation might not be profitable in any case since life cycle costs of ANCS strongly depend on the expected savings in energy and chemicals as well as on the financing mode. In general, it can be stated that under the assumptions used, ANCS reaching conservative estimations of energy savings can only be profitable with contracting, whereas ANCS reaching the potential estimations is profitable in any case. This is why in real life the financing mode will be customized so that implementing ANCS is aimed to be viable according to the customer’s plant’s configurations and its respective estimation of savings in energy and chemicals that can be realized. Hence, before implementing ANCS careful cost planning has to be done in order to ensure that the ANCS investment can be covered by the realized savings over time.

However, it should be highlighted in any case that within this case study ANCS was just applied to the backwash water treatment process of DWTP Roetgen. Of course, the concept of ANCS could be applied in the drinking water treatment process as well. The amortization rates for ANCS investment are assumed to be even higher in this case independent of the financing mode applied due to higher savings.

Table 4-9: Summary of LCA and LCC results for WAG case study

	Status quo (2014)	ANCS (conservative)	ANCS (potential)
<b>Environmental impacts</b>			
Carbon footprint [g CO <sub>2</sub> -eq/m <sup>3</sup> <sub>Q<sub>in</sub></sub> ]	124	110	95
Energy demand (fossil) [MJ]/m <sup>3</sup> <sub>Q<sub>in</sub></sub>	1.53	1.37	1.2
<b>Life Cycle Costs</b>			
Investment cost [EUR/m <sup>3</sup> <sub>Q<sub>in</sub></sub> /yr.)]	1.37	1.38 - 1.41	1.38 - 1.41
Operational cost [EUR/m <sup>3</sup> <sub>Q<sub>in</sub></sub> ]	0.19	0.19	0.18
Total life cycle cost [EUR/m <sup>3</sup> <sub>Q<sub>in</sub></sub> ]	0.18	0.17 - 0.18	0.17

#### 4.4.4 Conclusions and Unique Selling Propositions

From the LCA and LCC assessment in this case study, the following unique selling propositions of ANCS systems for optimisation of membrane operation could be deducted:

##### **USP1: Optimisation of electricity and chemicals demand for operation with reasonable pay-back time**

ANCS is a reasonable technology to reduce the electricity and chemicals demand for operation. Although the costs of ANCS implementation are strongly case specific, variable financing modes offered by the technology provider ensure that a reasonable pay-back-time can be realized in most cases.

##### **USP2: Potential for optimisation of capacity**

Although the volume of backwash water treated was assumed to be stable within the calculations presented above, implementing ANCS technology can have a positive influence on the system's capacity, too. As the control system optimizes the CEB cycle the amount of backwashes required for membrane cleaning can be reduced so that the overall capacity of the existing plant may increase.

## 5 Advanced Oxidation Processes (AOPs)

### 5.1 Technology description and relevant application areas

The usage of oxidative agents such as chloride, ozone and UV radiation are established methods in wastewater treatment and drinking water production to reduce pathogen loads, taste and odour components in the effluent water. Oxidative processes can also be used reduce emerging contaminant loads through the oxidation of a wide range of chemical structures. The chemical transformation in many cases eliminates deleterious effects of emerging contaminants, but the formation of unknown reaction products is an important consideration and studied by DEMEAU work area 3. Ozonation and Advanced Oxidation Processes are thereby key processes considered in DEMEAU and are described in more details in the following two paragraphs.

**Ozonation:** Ozone ( $O_3$ ) is a strong oxidizing agent that in contact with water forms hydroxyl radicals ( $OH\cdot$ ), which are among the most powerful oxidising substances known (e.g. Ravazini et al., 2006). Ozone reacts directly with many inorganic and organic substances in the water ('direct oxidation') and selectively attacks certain chemical bonds such as  $C=C$  double bonds, phenolic compounds and amino groups (Abegglen and Siegrist 2012b). In addition, the formed hydroxyl radicals react very fast and unspecific with many substances ('indirect oxidation'). Both direct and indirect oxidation increase the susceptibility of the compounds to subsequent biological degradation (FOEN 2007), e.g. by biological reactions in a sand filter. Because ozone is not stable and explosive at high concentration and high pressure, it has to be generated onsite through electrical discharges in an ozone generator from purified air or liquid oxygen, which is very energy demanding. Approximately 90 % of the energy used is transformed into heat during the process (Abegglen and Siegrist 2012b). The reaction between the water to be purified and ozone takes place in the ozone reactor (Figure 5-1) and off-gas is degraded by a catalytic or thermic residual ozone destruct unit. For the elimination of emerging contaminants, the ozone exposition (product of ozone concentration and reaction time) is the most important parameter. Since ozone is a highly irritating gas causing irritated airways, nausea and respiratory distress, maximum air concentrations have to be insured (e.g. in Switzerland max.  $200 \mu g m^{-3}$  air, (SUVA 2006).

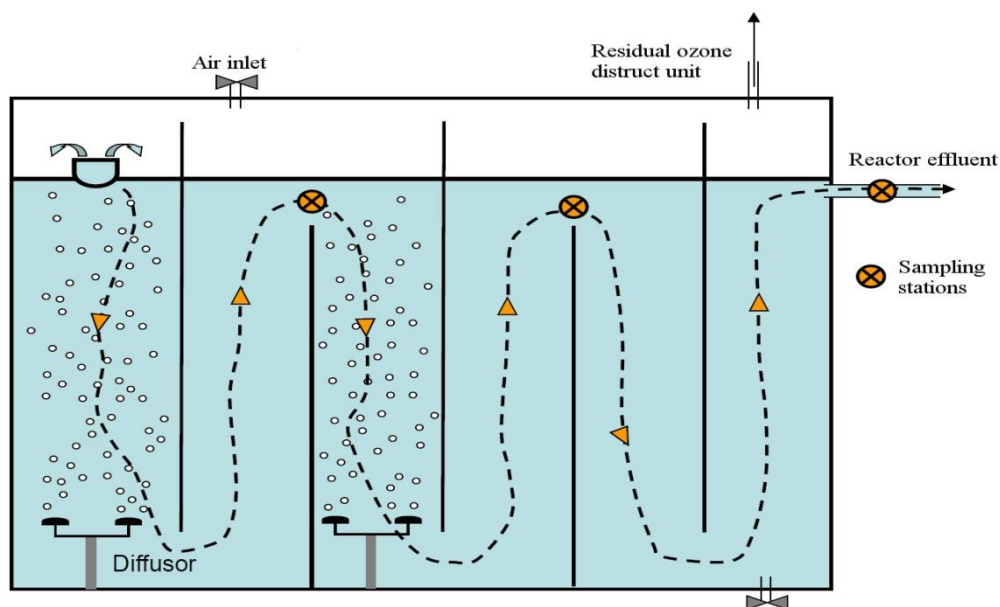

Figure 5-1: Schematic drawing of an ozone reactor, translated from: Abegglen and Siegrist 2012

**Advanced Oxidation Processes (AOPs):** Advanced Oxidation Processes are based on free hydroxyl radicals (OH $\cdot$ ), which are among the most powerful oxidising substances known (e.g. (Ravazzini et al. 2006). To date, AOPs have been primarily used for the treatment of industrial wastewater and in some cases for drinking water production. For municipal wastewater, only experiences based on laboratory experiments and small pilot plants exist (Abegglen and Siegrist, 2012). Considered AOP processes include the following:

- **UV with H<sub>2</sub>O<sub>2</sub>.** Hydrogen peroxide is cleaved into hydroxyl radicals by UV radiation.
- **Fe<sup>2+</sup> and H<sub>2</sub>O<sub>2</sub>.** Iron (Fe<sup>2+</sup>) catalyses the formation of hydroxyl radicals from H<sub>2</sub>O<sub>2</sub> (Fenton's reagent).
- **Fe<sup>2+</sup>, H<sub>2</sub>O<sub>2</sub> and UV.** Fenton's reagent can be combined with a UV light source.
- **O<sub>3</sub> and H<sub>2</sub>O<sub>2</sub>.** As ozonation, but addition of hydrogen peroxide increases production of hydroxyl radicals.

## 5.2 Case studies conducted in DEMEAU

Within DEMEAU WA3, advanced oxidation technologies and controlling methods have been up-scaled, tested and demonstrated for wastewater and drinking water treatment.

For drinking water production, the following two case studies were conducted within WP31:

- **Waterworks Zurich:** At the waterworks Zurich, lake water is treated with ozone. Within DEMEAU, a combined treatment of ozone and hydrogen peroxide was tested. The reactor is planned to be followed by activated carbon filtration and ultrafiltration. This pilot-scale set-up is expected to provide optimized emerging contaminant control.
- **Dunea MAR (Dan Haag, Netherlands):** At Dunea, a managed aquifer recharge project has operated since 1954 (see chapter 2.2.2). Because the source water (Meuse River) contains different emerging contaminants, a prototype of a H<sub>2</sub>O<sub>2</sub>/O<sub>3</sub>/UV oxidation prior to infiltration into the aquifer is planned to be installed.

For wastewater treatment, the following case study was conducted in WP31:

- **WWTP Neugut (Duebendorf, Switzerland):** A first full-scale ozonation in Switzerland is constructed in the existing WWTP Neugut and started operation in spring 2014. DEMEAU WA5 analyses the ozonation at the WWTP Neugut and a more detailed description is provided in the following chapter (5.2.2).

## 5.3 CS3.1: Ozonation of WWTP effluent

### 5.3.1 Case study description

#### 5.3.1.1 Current system

The wastewater treatment plant (WWTP) Neugut was built in 1964. The current design is based on mechanical cleaning, biological treatment (including biological phosphorus removal) and is extended by an additional ozonation stage before the existing sand filtration to eliminate organic emerging contaminants. This is the first full scale ozonation on a Swiss WWTP ([http://www.neugut.ch/\\_upload/file/i\\_20141028-202750-676.pdf](http://www.neugut.ch/_upload/file/i_20141028-202750-676.pdf)).

The initial system is composed of mechanical cleaning (bar screen, sand- and grease trap, fine screen, pumps and primary clarifier), biological treatment (activated sludge tank, secondary clarifier, sand filtration and pumps) and phosphorus elimination (precipitation in the activated sludge tank by ferric



chloride). After thickening, sludge is used to produce biogas in four sludge digesters at the WWTP. The biogas is used on site to produce 1.12 million kWh/yr. electrical and 2 million kWh/yr. thermal energy in a combined heat and power plant. The digested sludge is stored until de-watering by centrifuge and subsequent drying by natural gas in a drum drier (900 kWh per ton evaporated water). The dried sludge is currently used as alternative fuel in a cement plant. From July 2015, the sludge will be dried in another wastewater treatment plant and incinerated on site.

**Key figures:**

Wastewater treatment plant capacity:	150'000 p.e.
Current load:	105'000 p.e.
Daily wastewater treatment:	15'000 to 55'000 m <sup>3</sup> /d
Carbon removal efficiency:	96 to 99%

5.3.1.2 Emerging contaminant removal system

The system is now extended by an ozonation stage between the existing final clarifier and the sand filter as depicted in Figure 5-2, which started operation in March 2014. Ozone is generated from gaseous oxygen, which is itself vaporized on site from liquid oxygen. The liquid oxygen is produced elsewhere, delivered per truck and stored on site. The ozone generator produces the required ozone from gaseous oxygen by electrical discharge. Water flows from the secondary clarifier to the ozone reactor, where ceramic diffusors diffuse ozone. The construction of the ozone reactor ensures an appropriate mixing of the treated water with ozone and an adequate contact time. The reactor has to be gas-tight, in order to insure workers safety. Ozone reacts with emerging contaminants, reducing or eliminating their adverse effects on the environment. Potential off-gas from the ozone reactor passes through a residual ozone destruction unit in order to meet ozone concentration limits in the ambient air. The pre-existing sand filtration is used as biologically active final stage, microbially degrading degradable oxidation transformation products of the ozonation. The installation of ozone treatment also requires the installation of ozone sensors in the working rooms in order to assure operators safety. Figure 5-3 shows pictures of the oxygen tank with evaporator and the ozone generator.

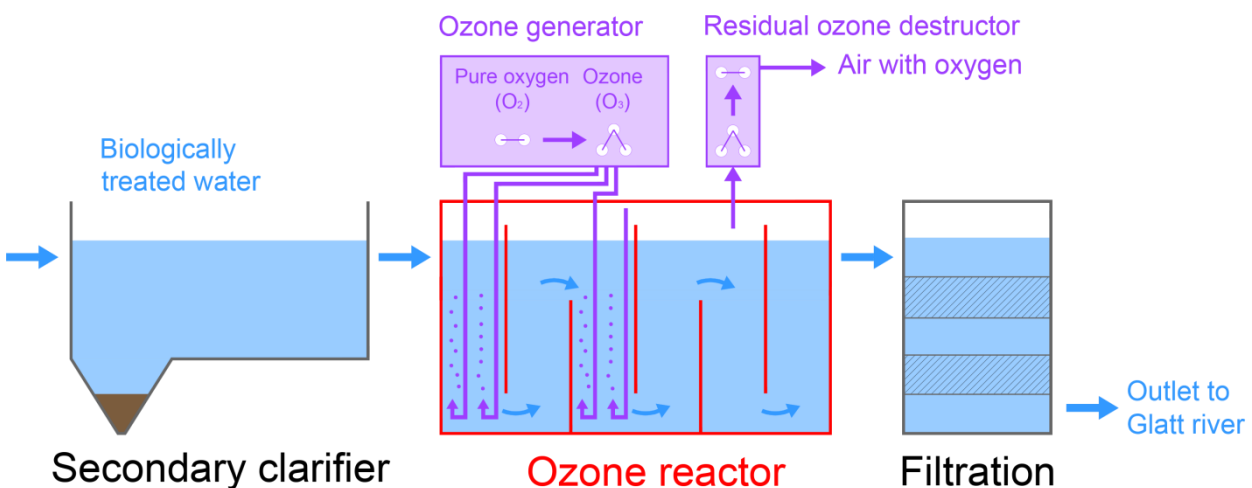

Figure 5-2: Flow chart of the new ozone reactor at the wastewater treatment plant Neugut (source: WWTP Neugut)



Figure 5-3: Oxygen tank with evaporator, ozone generator

In combination with the biological treatment and the sand filtration, the ozonation at the WWTP Neugut removes more than 80% of emerging contaminants found in the wastewater (WWTP Neugut 2014). Ozonation has been shown to reduce a wide spectrum of emerging contaminants at high removal rates. An optimal ozone dose has been determined as 0.55 g O<sub>3</sub>/g DOC (2.0 – 3.3 mg O<sub>3</sub>/L). In a nearby WWTP in Regensdorf (Switzerland), the removal efficiency of 220 emerging contaminants was assessed after an upgrading with ozonation followed by sand filtration (Hollender et al. 2009). With a slightly higher ozone dose of 0.62 g O<sub>3</sub>/g DOC (ca. 3 mg O<sub>3</sub>/L) most of the emerging contaminants were removed to > 85% compared to the raw wastewater. Largely persistent to ozonation were x-ray contrast media (iopromide) and some herbicides (Mecoprop, Atrazine). Further benefits include disinfection.

### 5.3.2 LCA and LCC: Definition of goals and scope

#### 5.3.2.1 Definition of goals

The goal of this study is to compare environmental and economic impacts and benefits of the wastewater treatment including oxidation process through ozonation with the business-as-usual scenario. To do so, we evaluate the impacts, benefits and costs of the entire wastewater treatment plant in Neugut, with a focus on the newly built ozonation system. These results then serve as a basis to reveal the unique selling point of the ozonation technology compared to the others, supporting the overall goals of DEMEAU of promoting innovative and already full scale-applied technologies for removal of emerging contaminants.

#### 5.3.2.2 System boundaries and investigated systems

The system boundaries encompass the material and energy inputs required for the entire wastewater treatment plant infrastructure and operation as well as direct air and water emissions on-site. We consider the two following scenarios presented in Figure 5-4:

- **BAU:** business-as-usual wastewater treatment in Neugut including mechanical cleaning, biological treatment, including nitrification and denitrification, and phosphorus elimination (for an average flow of wet and dry weather conditions)
- **O<sub>3</sub>:** wastewater treatment including oxidation process through ozonation (for an average flow of wet and dry weather conditions)

Scenario BAU: business-as-usual wastewater treatment including mechanical cleaning, biological treatment and phosphorus elimination

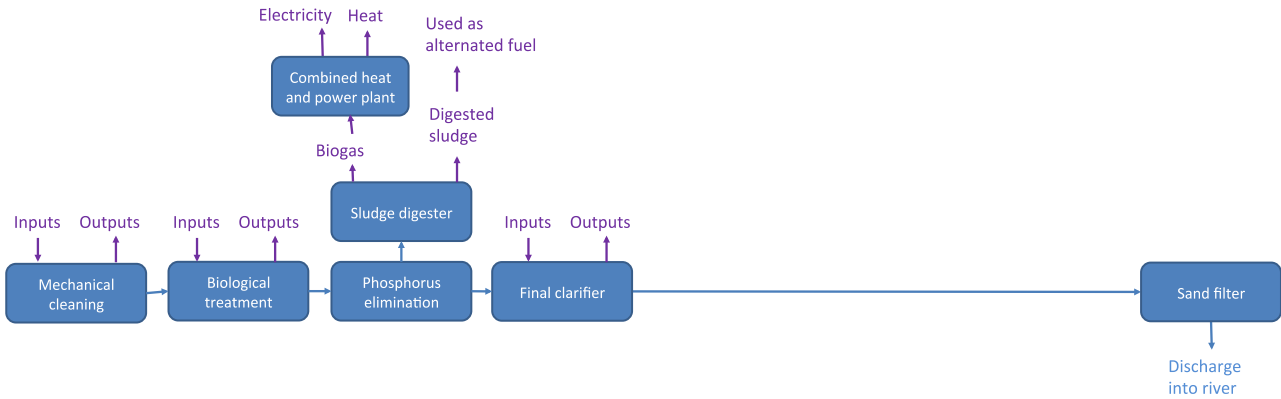

Scenario O3: wastewater treatment including advanced oxidation process through ozonation

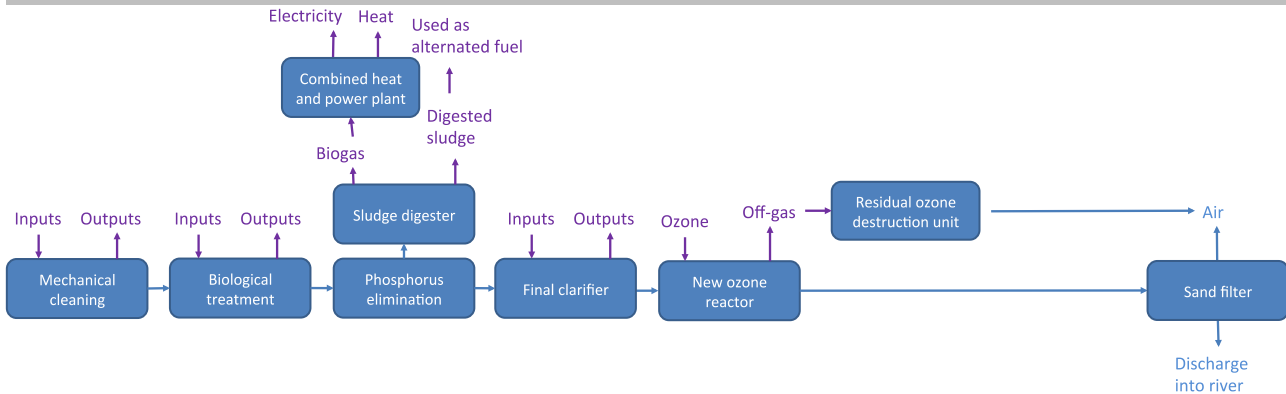

Figure 5-4: System flow charts for the BAU and O<sub>3</sub> scenarios

In the upgraded scenario, an ozone reactor is added before sand filtration and discharge in the river. The entire water flow coming to the wastewater treatment plant is treated (by-pass for maintenance only).

5.3.2.3 Functional unit

The functional unit is: 1 m<sup>3</sup> of municipal wastewater released (including wet and dry weather conditions that correspond overall to 8'600'000 m<sup>3</sup>/year).

5.3.2.4 LCA and LCC inventory

Table 5-1 shows the LCA inventory collected from the Neugut wastewater treatment plant operators. The main process operation includes net electricity import from the grid (the electricity produced at the combined heat and power plant and used internally does not appear in the results), material inputs such as ferric chloride and flocculant, the amount and composition of the produced biogas and digested sludge. The main plant infrastructure requirements are difficult to collect as the wastewater treatment plant was built in 1964 and thus is modeled with a generic process. All ecoinvent processes are provided in Annex-D. The ozonation operation includes the oxygen and electricity input to

produce ozone while the ozonation infrastructure includes each ozonation component material (mainly concrete and steel), mass and estimated lifetime. The emissions into water rely on regular measurements at the Neugut plant for nutrients and Eawag measurements for eleven monitored organic emerging contaminants included in DEMEAU deliverable D31.1. The nutrient removal load to estimate a scenario without wastewater treatment were collected from Neugut wastewater treatment plant operators and the emerging contaminant removal through the ozonation system is provided by Eawag.

Table 5-1: Life cycle inventory of the WWTP Neugut as in 2013, ozonation process as of 2014 (source: WWTP Neugut) and emerging contaminant concentration (source: Eawag)

Parameters for BAU and ozonation infrastructure and operation	Unit	Value
<b>Main plant processes operation</b>		
Net electricity consumption from the grid	kWh/yr.	2'880'000
Ferric chloride (as 13.8% FeCl <sub>3</sub> )	kg Fe/yr.	12'000
Primary sludge production and solids concentration and volatile solids	t DM/d	4.3
Activated sludge production and solids concentration and volatile solids	m <sup>3</sup> /d	100
	%	21.5 % ash: 78.5 % Volatile solid
Activated sludge production and solids concentration and volatile solids	t DM/d	2.5
	%	35.2 % ash? Volatile solid 64.8%
	m <sup>3</sup> /yr.	100
Which share of the sludge is used as fuel in the cement plant?		100%
	m <sup>3</sup> /yr.	560'000
Biogas production + quality	[% CH <sub>4</sub> ]	62% CH <sub>4</sub>
	[Nm <sup>3</sup> Biogas/kg VS]	0.97 m <sup>3</sup> /kg organic DM degraded
Heat production	kWh/yr.	2'000'000
Electricity production	kWh/yr.	1'120'000
Digested sludge production	t TS / a	913.56
Is there sludge drying?	yes/no	yes
Final water content of the digested sludge	%	92
Flocculant	kg /yr.	42'000
<b>Ozonation operation</b>		
Ozone dose	[g/m <sup>3</sup> ]	3 (flow-proportional dosing)
Oxygen input	[kg O <sub>2</sub> / kg O <sub>3</sub> produced]	10
Electricity consumption for ozone production	kWh/kgO <sub>3</sub>	9
<b>Ozonation infrastructure</b>		
Filter	Mass [kg]	180'000
Filter	Material	sand
Estimated lifetime of the filter	a	15
Oxygen tank	Mass [kg]	47'000
Oxygen tank	Materials	steel
Ozone generator	Mass [kg]	2'000
Ozone generator	Materials	stainless steel
Ozone reactor	Mass [kg]	60'000
Ozone reactor	Materials	concrete
Ozone and oxygen sensors	Mass [kg]	5
Ozone and oxygen sensors	Materials	steel
Residual ozone destruction unit	Mass [kg]	150
Residual ozone destruction unit	Materials	stainless steel
Filter inlet unit	Pipe length [m], diameter	0

Parameters for BAU and ozonation infrastructure and operation	Unit	Value
Filter inlet unit	Diameter [m]	8 m
Filter inlet unit	Materials	steel
Civil construction works	[m <sup>3</sup> concrete]	300
Civil construction works	[t steel]	20
Pipes	[m pipes]	150 m
Estimated lifetime of each piece of oxygen tank	[yr.]	15
Estimated lifetime of each piece of ozone generator	[yr.]	15
Estimated lifetime of each piece of ozone reactor	[yr.]	30
Estimated lifetime of each piece of ozone and oxygen sensors	[yr.]	10
Estimated lifetime of each piece of residual ozone destruction unit	[yr.]	15
Estimated lifetime of each piece of filter inlet unit	[yr.]	15
Estimated lifetime of each piece of civil construction work	[yr.]	30
Estimated lifetime of each piece of pipes	[yr.]	15
How much of the input water is treated in dry weather?	%	100
How much of the input water is treated in wet weather?	%	660 l/s (100% of wet weather flow)
<b>Emissions into water (after ozonation with 3 mg/L O<sub>3</sub> = 0.54±0.05gO<sub>3</sub>/gDOC)</b>		
BOD <sub>5</sub> , Biological Oxygen Demand	mg/L	3.8
COD, Chemical Oxygen Demand	mg/L	12
Nitrate	mg/L	10.9
Total phosphorus	mg/L	0.23
Ammonium ion	mg/L	0.136
Nitrite	mg/L	0.111
Benzotriazole	ng/L	502-780
Bezafibrate	ng/L	< LOQ (3)
Carbamazepine	ng/L	< LOQ (4)
Diclofenac	ng/L	< LOQ (4) - 8
Iopromide	ng/L	481-1019
Mecoprop	ng/L	8-12
Metoprolol	ng/L	7-23
Phenazone (Antipyrine)	ng/L	< LOQ (3)
Primidone	ng/L	41-44
Sulfamethoxazole	ng/L	< LOQ (4) - 8
Trimethoprim	ng/L	< LOQ (7)
<b>Removal efficiencies for the nutrient load over the whole plant and for emerging contaminants only through the ozonation system (3 mg/L O<sub>3</sub> = 0.54±0.05gO<sub>3</sub>/gDOC)</b>		
BOD	%	99
COD	%	96
total P	%	95
NH <sub>4</sub> -N	%	99
TN	%	73
Benzotriazole	%	74
Bezafibrate	%	>75
Carbamazepine	%	>98
Diclofenac	%	100
Iopromide	%	43
Mecoprop	%	77
Metoprolol	%	94
Phenazone (Antipyrine)	%	>92
Primidone	%	66
Sulfamethoxazole	%	>97
Trimethoprim	%	>61

Cost data for the business-as-usual treatment and the advanced oxidation process through ozonation was compiled in cooperation with the local partner (ARA Neugut) (Annex-D).

5.3.2.5 Assumptions

We made several assumptions to fill the gap between required data and collected data. Table 5-2 summarizes key assumptions used in the model.

Table 5-2: Key modelling assumptions

Life cycle system part	Assumption
Main plant infrastructure	<ul style="list-style-type: none"> <li>Generic process from the ecoinvent v2.2 database <i>Wastewater treatment plant, class 2/CH/I U</i>.                             <ul style="list-style-type: none"> <li>annual volume treated: 14'400'000 m<sup>3</sup>/year (compared to 8'600'000 in Neugut)</li> <li>lifetime: 30 years</li> </ul> </li> </ul>
Sludge burning	<ul style="list-style-type: none"> <li><b>Sludge amount:</b> 0.11 kg wet sludge with 8% of water / m<sup>3</sup> treated</li> <li><b>Sludge recovery:</b> 100% of the sludge is dried and burned in a cement plant, as a substitute for coal</li> <li><b>LHV for sludge with 50% water:</b> 4 MJ / kg (<a href="http://www.waterleau.com/files/Integrated_sludge_treatment.pdf">http://www.waterleau.com/files/Integrated_sludge_treatment.pdf</a>)</li> <li><b>Sludge incineration inventory:</b> modelled with the tool for waste disposal in Municipal Solid Waste Incinerators MSWI for ecoinvent v2.1 (2008)</li> </ul>
Emissions into air	<ul style="list-style-type: none"> <li><b>N<sub>2</sub>O emissions:</b> 0.5% of denitrified N (expert judgement: 70% of total N is present as NH<sub>4</sub>) is transformed into N<sub>2</sub>O (expert estimation from Neugut plant operators)</li> <li><b>NH<sub>3</sub> emissions:</b> 0.6% of influent NH<sub>4</sub> (expert judgement: 70% of total N is present as NH<sub>4</sub>) is transformed into gaseous NH<sub>3</sub> (adopted from Bardtke et al., 1994).</li> </ul>
Emissions into water	<ul style="list-style-type: none"> <li><b>Ozonation transformation products:</b> We assume that emerging contaminants are degraded with ozonation and that there are no toxic transformation products in the wastewater treatment plant effluent after sand filtration (see results of WA4)</li> </ul>
Other	<ul style="list-style-type: none"> <li>Flocculant transformation products are not considered in water emissions</li> <li>Electricity and heat recovery from biogas burning are used internally at the wastewater treatment plant</li> </ul>

5.3.2.6 Key limitation

The LCA method represents potential environmental impacts modelled based on collected data and generic databases of inputs and outputs required for industrial and agricultural processes. In this sense, there are several limitations that should be kept in mind while interpreting the results.

One key limitation is that the potential impacts are not site-specific, given that the USEtox model is generic (it does not consider local hydrology, water quality and species sensitivity). This means that this approach cannot be used to reflect the reality in a specific catchment, e.g the receiving water of a WWTP. While interpreting the results in this report, the reader should thus keep in mind that the LCA provides results only on a global scale, but they are thus not representative of the impact in the catchment specifically. The results should be rather interpreted as the impact of a generic treatment with and without ozonation, representative of a global average more than a local situation.

Another limitation is that the ozonation transformation products are not considered in this model. In reality, the ozonation breaks down a share of the organic emerging contaminants into simple compounds that are partially / totally removed by the sand filter. The share of emerging contaminants that is not removed or broke down into transformation products is released in receiving water. In the LCA model, ozonation transformation products are not considered at all, while emerging contaminants that are not removed by the system and released as such in the river are considered (this is what is represented as “water emissions” in the dark blue bar in the results).

### 5.3.3 Results and discussion

#### 5.3.3.1 LCA impact assessment

#### Overall performance in nutrient removal

WWTPs treat household and industrial wastewater and are therefore key-players in insuring surface water quality. This water quality improvement can be seen through the life cycle indicator “freshwater and marine eutrophication” shown in Figure 5-5, where the environmental performance of a scenario without any water treatment is compared with the BAU and O<sub>3</sub> scenarios for the freshwater and the marine eutrophication impact indicators. Given that the Neugut wastewater treatment plant primarily aims at reducing the total eutrophying load, these results show that the wastewater treatment reduces the wastewater impact on freshwater and marine eutrophication (P emissions reduced by 95% and N emissions reduced by 73%, information from Neugut operators). The contribution of the O<sub>3</sub> system compared to the impact of the BAU scenario is less than 2% for both indicators. Without any treatment, the impact is more than 10 times higher than if the wastewater is treated for the indicator freshwater eutrophication.

However, since a WWTP consumes electricity and chemicals, it also impacts the environment through other impact categories such as climate change and terrestrial acidification as presented in the following paragraph.

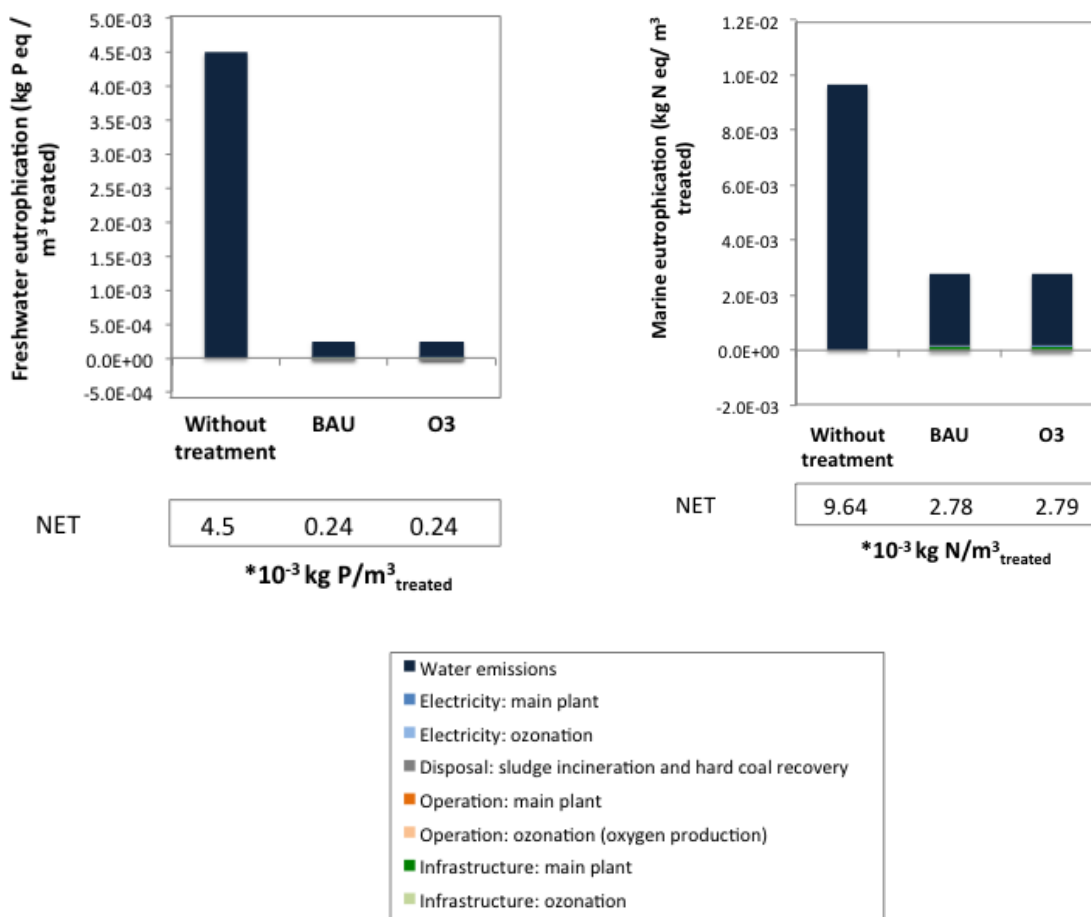

Figure 5-5: Overall wastewater treatment plant performance: freshwater and marine eutrophication results for no wastewater treatment, BAU and O3 scenarios

### Global results

Figure 5-6 shows the global results where the BAU and O<sub>3</sub> scenario are compared for all studied indicators. The main plant infrastructure contributes to a significant part of the impact for all impact categories (4 to 61%), followed by electricity consumption for the main plant operation (1 to 85%). The negative impact in grey reflects the benefits from sludge burning. Indeed, in LCA, co-products that have an economic value (such as sludge which can be used as fuel) are model as (1) the benefit (negative impact) of substituting another product (in this case, coal) that does not need to be produced and (2) the impact of using this product (in this case, emissions from sludge burning). In this case, the impact and benefit sum as an overall benefit represented by the grey bar. The impact of the ozonation (mainly liquid oxygen and electricity production) adds from 0 to 10% of the impact among all categories compared to the baseline scenario. The different indicator scenarios are discussed in detail in the following paragraphs.

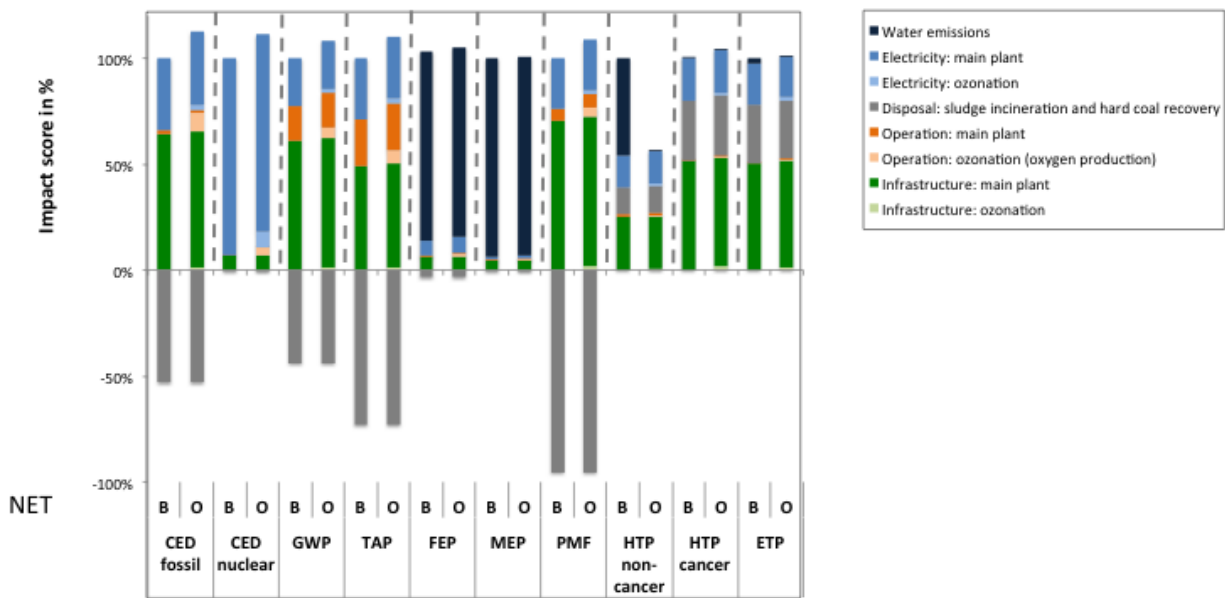

Figure 5-6: Overall wastewater treatment plant performance: freshwater and marine eutrophication results for no wastewater treatment, BAU and O<sub>3</sub> scenarios Overall wastewater treatment plant performance

CED fossil: Cumulative Energy Demand fossil, CED nuclear: Cumulative Energy Demand nuclear, GWP: Global Warming Potential, TAP: Terrestrial Acidification Potential, FEP: Freshwater Eutrophication Potential, MEP: Marine Eutrophication Potential, PMF: Particulate Matter Formation, HTP non-cancer: Human Toxicity Potential non-cancer, HTP cancer: Human Toxicity Potential cancer, ETP: Ecotoxicity Potential, B: Business-as-usual scenario, O: Ozonation scenario

### Cumulative energy demand

Figure 5-7 shows the impact on cumulative energy fossil and nuclear for the BAU and O<sub>3</sub> scenarios. For both indicators the O<sub>3</sub> scenario is slightly more impactful (12% for CED, fossil and 11% for CED, nuclear) due to additional electricity consumption and oxygen production for ozonation.



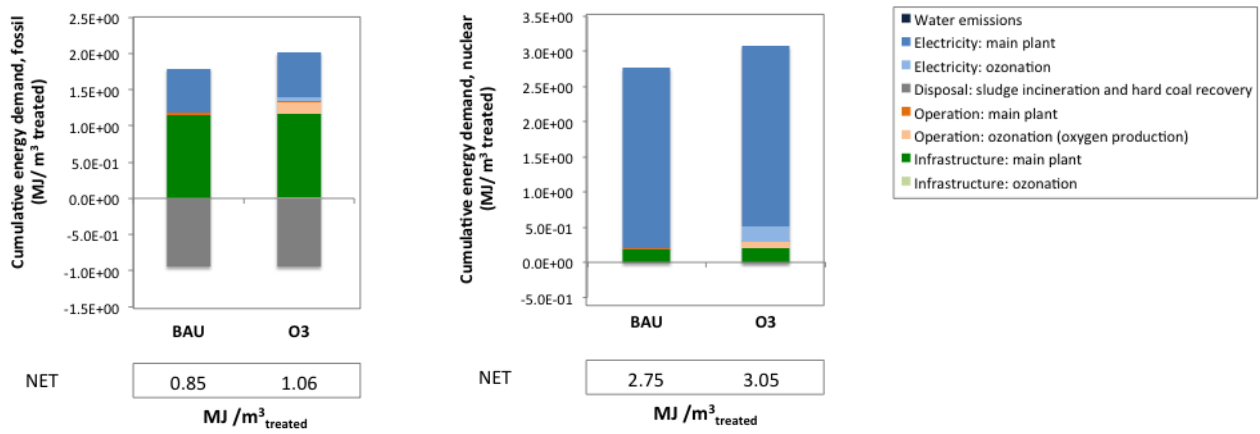

Figure 5-7: Overall wastewater treatment plant performance: freshwater and marine eutrophication results for no wastewater treatment, BAU and O<sub>3</sub> scenarios Impact on cumulative energy demand, fossil and nuclear of BAU and O<sub>3</sub> scenario

### Climate change

For impact on climate change, Figure 5-8 shows that the liquid oxygen and electricity production required in the O<sub>3</sub> scenario adds 8% more impact (+ 0.018 kg CO<sub>2</sub>eq /m<sup>3</sup>) on climate change compared to the BAU scenario (impact of 0.22 kg CO<sub>2</sub>eq /m<sup>3</sup>). The low contribution of electricity production can be explained by the low impact on climate change of the Swiss electricity mix given less than 10% of the electric energy in Switzerland is based on fossil fuels or coal.

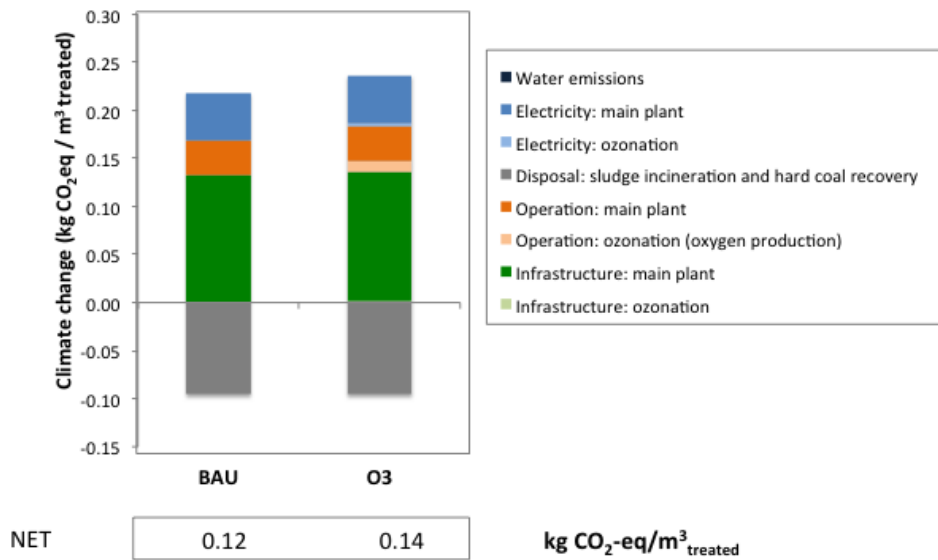

Figure 5-8: Impact on climate change of BAU and O<sub>3</sub> scenario

Figure 5-9 shows the modelled O<sub>3</sub> scenario in Germany (with German electricity grid mix) to test the influence of the grid mix on the results. The impact of the Neugut plant with the ozonation system with the German grid mix provides results 80% larger than with the Swiss grid mix.

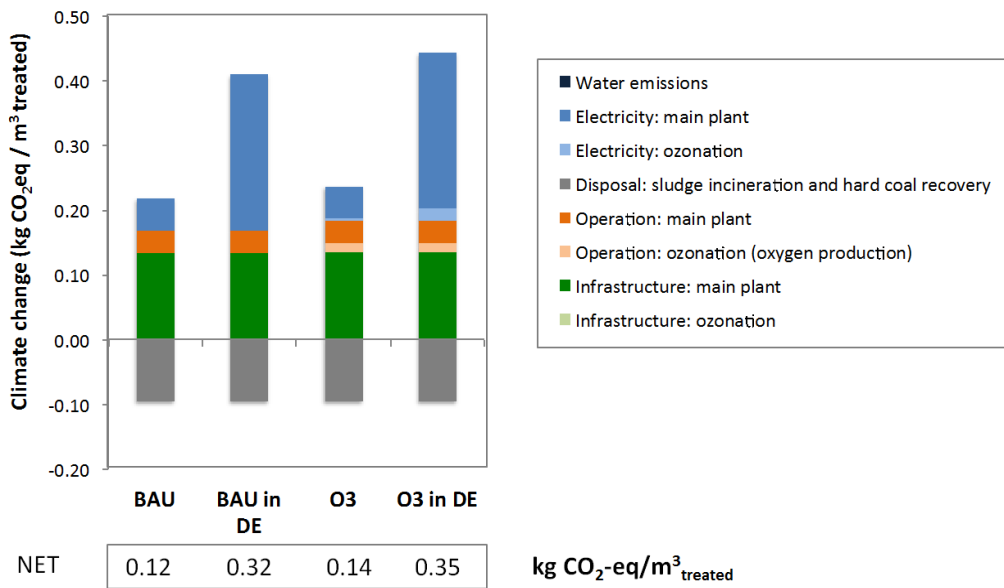

Figure 5-9: Impact on climate change of the BAU and O<sub>3</sub> scenarios compared to an O<sub>3</sub> scenario with the wastewater treatment plant located in Germany

**Contribution analysis of the wastewater treatment plant process to climate change:**

We explored the origin of the contribution of the wastewater plant infrastructure impact on climate change, both used in the BAU and the O<sub>3</sub> scenarios (green bar of the previous figure). Figure 5-10 shows that concrete and reinforcing steel contribute to 79% of the impact for the ecoinvent process for wastewater treatment infrastructure.

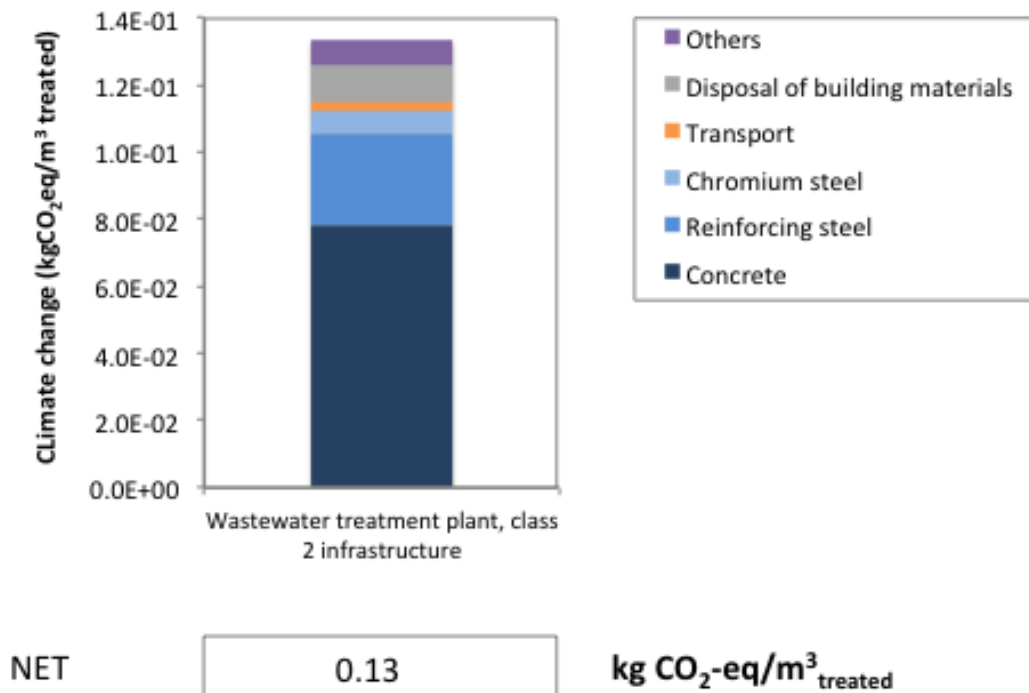

Figure 5-10: Contribution to climate change of the ecoinvent v2.2 process Wastewater treatment plant, class 2/CH/IU

**(Eco)toxicity results without extrapolation**

Figure 5-11 shows human toxicity cancer and non-cancer as well as ecotoxicity results for the BAU and O<sub>3</sub> scenarios. In this first analysis, the direct emissions into water are represented by the dark blue bar and are calculated based on the 11 monitored substances (6 specific characterization factors were developed within DEMEAU for substances that were not included in the USEtox database). The ozonation system reduces 43% of the impact on the human toxicity non-cancer effect category but appears negligible for the human toxicity cancer effect and ecotoxicity.

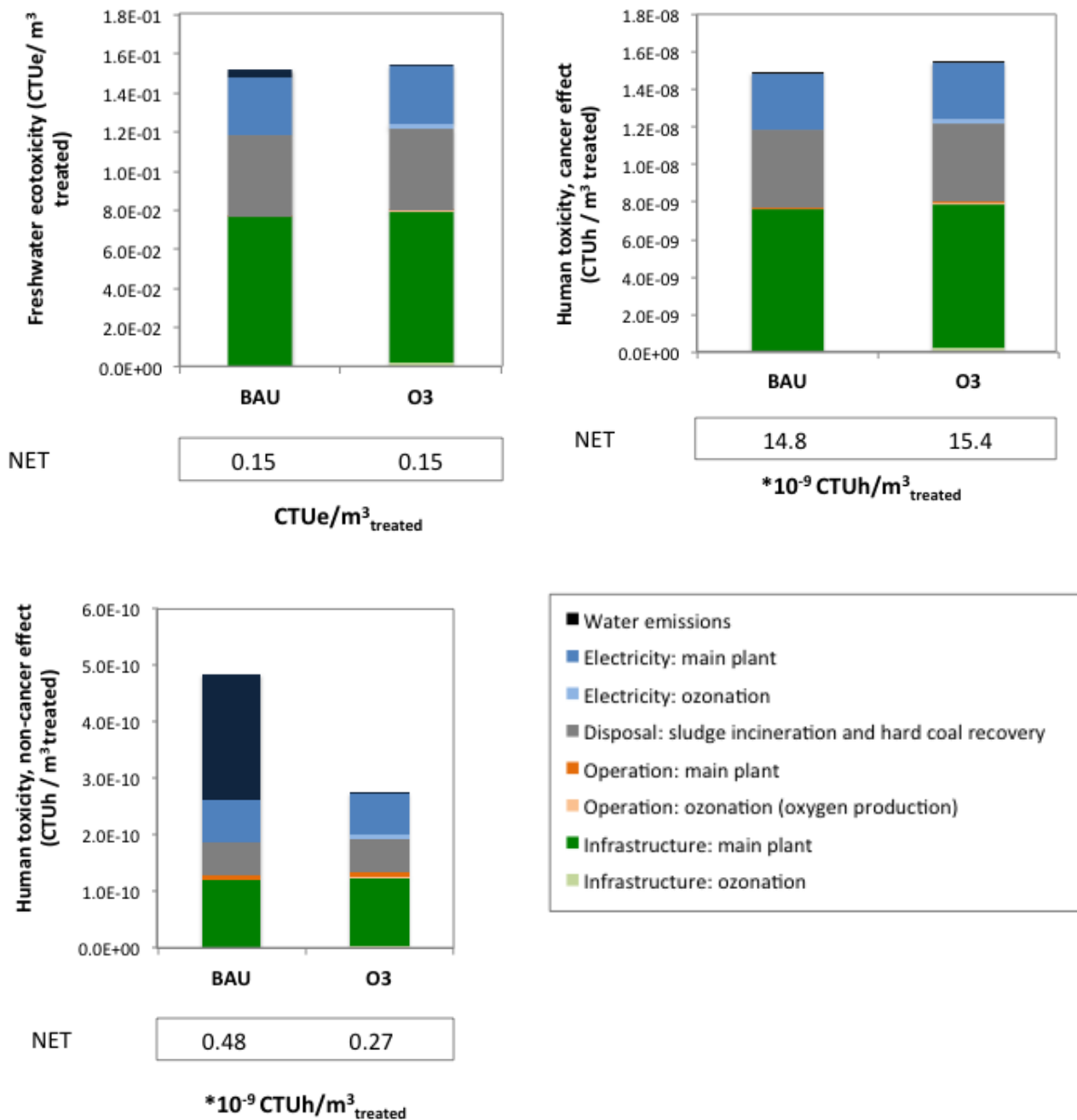

Figure 5-11: Contribution to human toxicity, cancer and non-cancer effect as well as ecotoxicity of BAU and O<sub>3</sub> scenarios for the 11 monitored DEMEAU substances

**(Eco)toxicity contribution analysis for direct water emissions**

Based on Eawag’s measurements of 11 monitored substances, Figure 5-12 presents a contribution analysis of each emerging contaminant for human toxicity cancer and non-cancer effect as well as for ecotoxicity. We can see that human toxicity, cancer effect is dominated by primidone emissions while non-cancer effect is dominated by diclofenac emissions. In fact, primidone is the only one of 11 emerging contaminants which both has a “human tox, cancer” factor and is measured > LOQ at Neugut. Freshwater ecotoxicity is dominated by diclofenac, followed by benzotriazole, and sulfamethoxazole emissions.

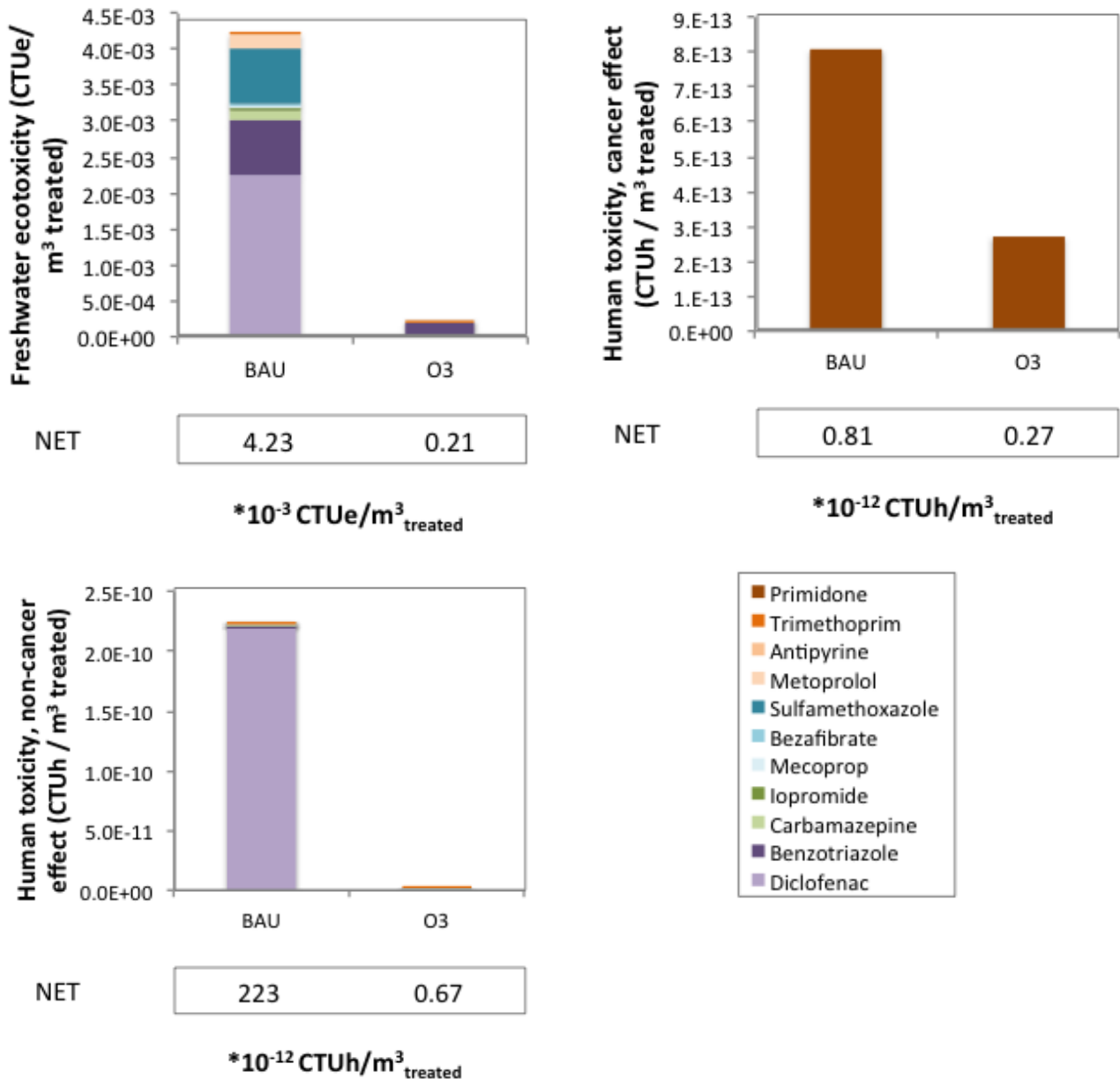

Figure 5-12: Contribution to human toxicity, cancer and non-cancer effect as well as ecotoxicity of BAU and O<sub>3</sub> scenarios

We then analyse the toxicity of the substances monitored at the Neugut wastewater treatment plant (per kg substance emitted) compared with organic substances covered in the USEtox database. The aim of this analysis is to see, independently of the amount of substance removed during ozonation and emitted into freshwater, what is the toxicity of each substance for one kg of substance emitted. We thus analyse the characterization factors of each substance compared to the substances included in the USEtox database, which covers more than 3'000 organic substances including pesticides, pharmaceutical substances, cosmetics, etc.

Figure 5-13 presents the characterization factor of the monitored substances compared to more than 3'000 substances covered in USEtox. Monitored substances cover a wide range of toxicity, most toxic substance on human health, non-cancer effect being diclofenac and the most toxic on aquatic ecotoxicity — sulfamethoxazole.

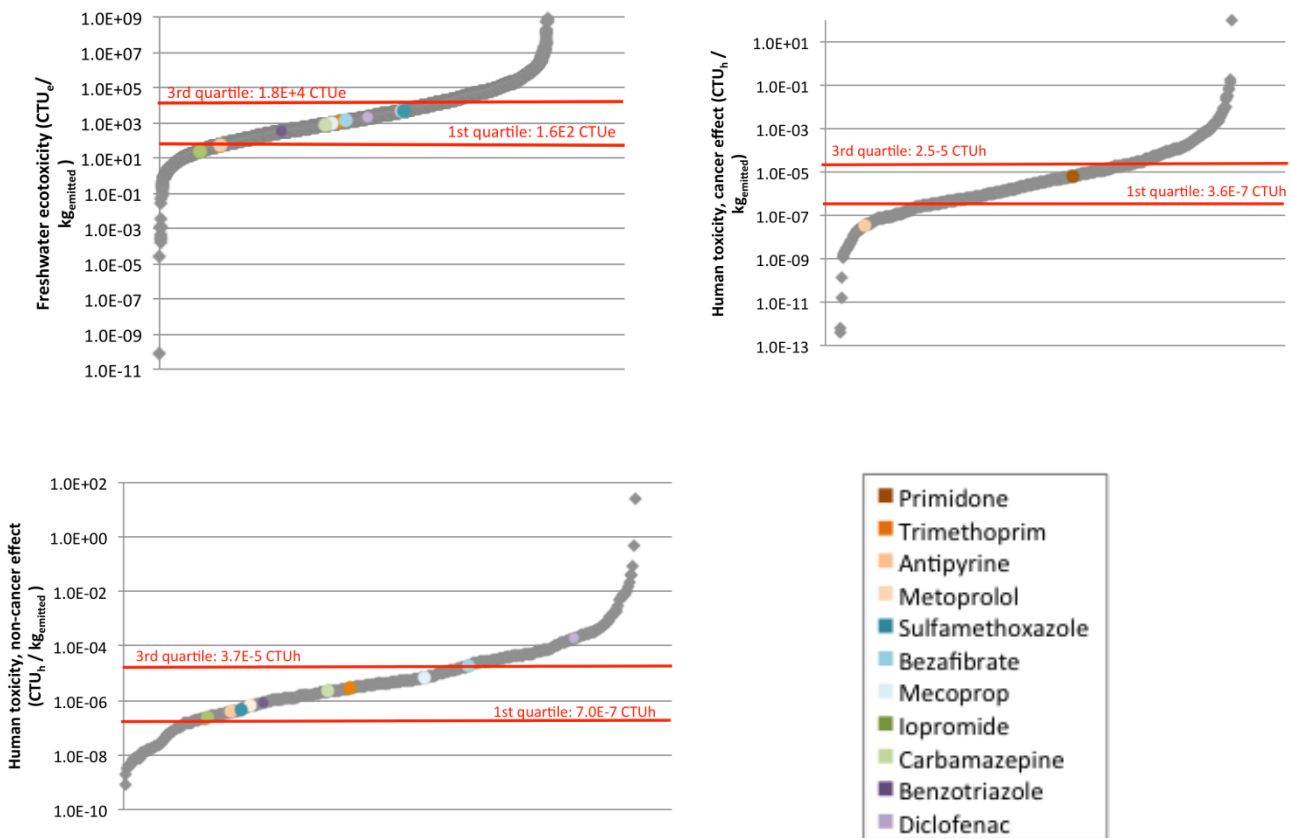

Figure 5-13: Characterization factors of monitored substances vs. substances covered in USEtox for human toxicity, cancer and non-cancer effect as well as ecotoxicity

**(Eco)toxicity extrapolation**

Given that the previous results are representative of only 11 monitored substances, we extrapolated the (eco)toxicity score to the entire emerging contaminant load present in municipal wastewater. The extrapolation results rely on three key uncertain parameters: (1) the emerging contaminant total load, which varies from one municipal sewage system to another, (2) its “average toxicity”, which is unknown and relies on 3 scenarios of low, average and high toxicity, and (3) the average substance removal, which is in reality substance specific. This extrapolation has thus a high uncertainty and the results should be interpreted with care given that in reality, each compound has a specific toxicity and removal rate. Table 4-3 describes these key extrapolation parameters in further details. When interpreting results, it is important to keep in mind the key limitation that the potential impacts are not site-specific, given that the USEtox model is generic (it does not consider local hydrology and species sensitivity).

**Table 5-3: Key parameters to estimate the entire emerging contaminant load toxicity**

Parameter	Assumption
Total emerging contaminant load	9.62E-05 kg.m <sup>-3</sup> We estimated total emerging contaminant load as an average of the load reported in Schwentner (2011) (1.16E-04 kg.m <sup>-3</sup> ), Margot et al. (2013) (8.18E-05 kg.m <sup>-3</sup> ) and Goetz et al. (2010) (9.05E-05 kg.m <sup>-3</sup> )
Average toxicity of the emerging contaminant load	3 scenarios: 1 <sup>st</sup> quartile, median and 3 <sup>rd</sup> quartile of USEtox organic substances toxicity Given the lack of knowledge on the average toxicity of the entire emerging contaminant load, we generated a toxicity characterization factor for 3 scenarios: the 1 <sup>st</sup> quartile, median and 3 <sup>rd</sup> quartile of the toxicity of the 3074 organic substances covered in USEtox
Substance removal	87% removal We assume 87% of substances are removed in the ozonation stage (average over 10 monitored substances in Neugut)

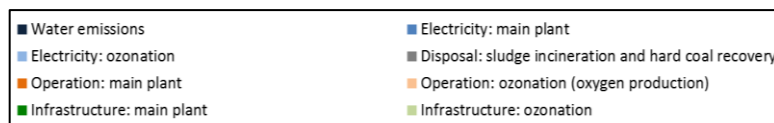

Figure 5-14 provides results of the BAU and O<sub>3</sub> scenarios for the 3 extrapolation scenarios assuming a low (1<sup>st</sup> quartile of USEtox organic substances), average (median of USEtox organic substances) and high toxicity factor (3<sup>rd</sup> quartile of USEtox organic substances). These scenarios thus take the USEtox organic substance list as a reference to define a value for low, average and high toxicity.

The ecotoxicity impact results show that the emerging contaminant emissions represent a significant contribution to the impact on human health, non-cancer effect from an average to high toxicity, i.e. from the median to 3<sup>rd</sup> quartile of organic substances in USEtox. Based on our initial assumption, the ozonation reduces the impact of emerging contaminants by 87%. The overall ecotoxicity score (encompassing both direct and indirect emissions) is reduced by 39% compared to the scenario without ozonation for the median toxicity scenario and by 80% for the 3<sup>rd</sup> quartile organic substances scenario. This leads to the conclusion that WWTP ozonation can foremost reduce the overall freshwater ecotoxicity (considering also the freshwater ecotoxicity generated by the rest of the considered system, e.g., the electricity use, in addition to the impact generated from direct emissions from the wastewater treatment plant), i.e. serve as protecting rivers and lakes from negative impact of WWTP effluent, as for example in the Neugut case in the Glatt river. This means that the emissions in water have a major contribution to the ecotoxicity impact compared to the rest of the life cycle when extrapolating to a full emerging contaminant load with average or high toxicity, which was not visible when considering only 11 monitored substances.

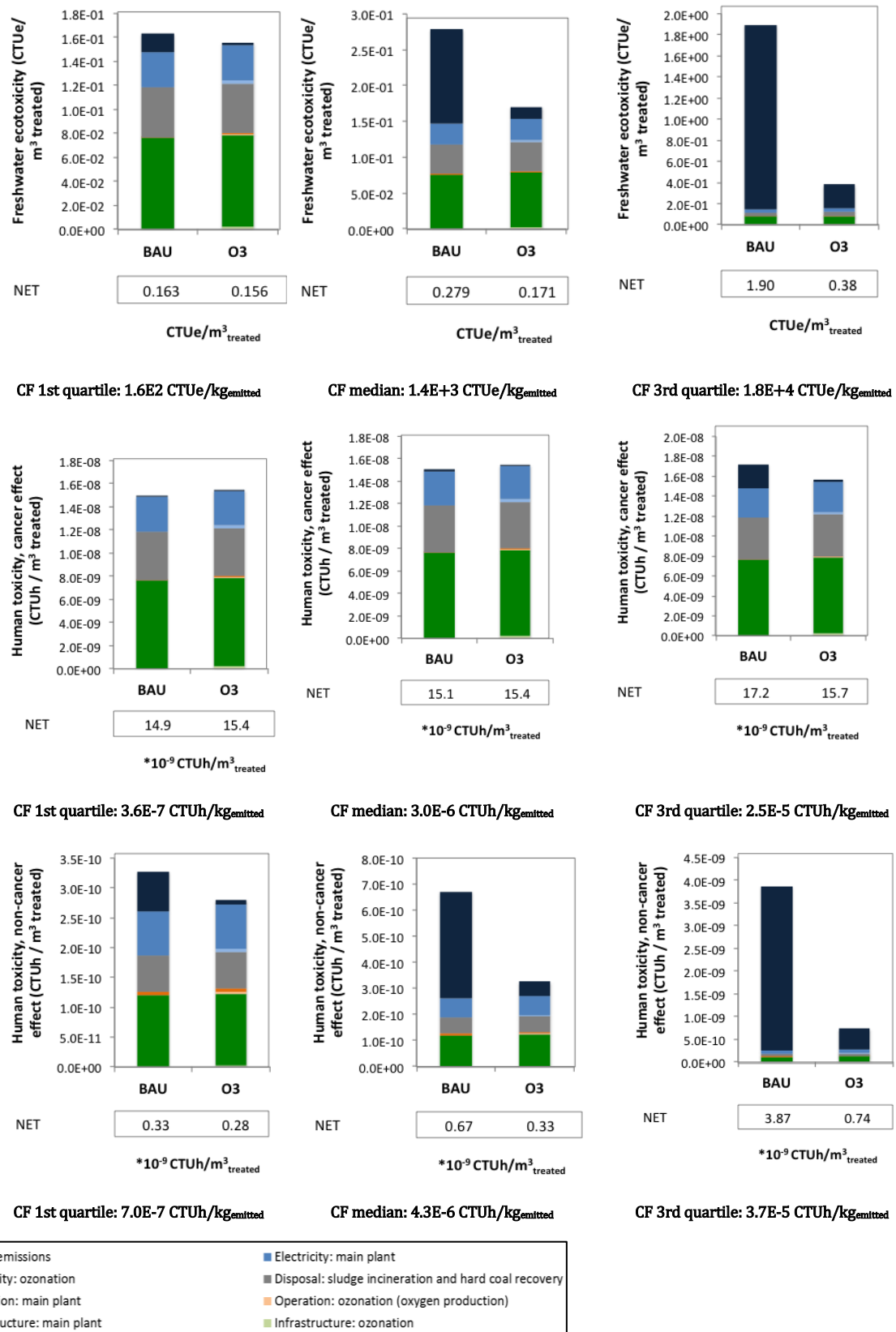

Figure 5-14: Results of the extrapolation of the emerging contaminant entire load contribution to human toxicity, cancer and non-effect as well as ecotoxicity of BAU and O<sub>3</sub> scenarios

The human health, cancer effect results show that the emerging contaminant emissions represent a significant contribution (14% of the total impact) to the impact on human health, cancer effect only in case the toxicity of the emerging contaminant load is assumed to be high, i.e. towards to 3<sup>rd</sup> quartile of organic substances in USEtox. For the CF at the 3<sup>rd</sup> quartile of organic substances in USEtox, the ozonation reduces the overall toxic score from 1.7E-8 to 1.6E-8 CTUh (2% of the total impact). The human health, non-cancer effect results show the same trend as for the ecotoxicity impact. The overall human toxicity score (encompassing both direct and indirect emissions) is reduced by 52% compared to the scenario without ozonation for the median toxicity scenario and by 81% for the 3<sup>rd</sup> quartile organic substances scenario.

In summary, when extrapolating the toxic impact to the entire emerging contaminant load, the emerging contaminant emissions represent a significant contribution to the freshwater ecotoxicity and the human health impact in case the toxicity of the emerging contaminant load is average to high, i.e. between the median and the 3<sup>rd</sup> quartile of organic substances CFs in USEtox. This confirms the relevance of using an advanced treatment system like ozonation that eliminates emerging contaminants to protect both freshwater ecosystem in rivers and lakes that receive the effluent as well as humans that ingest emerging contaminants through drinking water and fish.

**Other indicators**

Other indicators such as terrestrial acidification and particulate matter are presented in Annex-D.

5.3.3.2 LCC assessment

Capital and operational costs of the business-as-usual treatment as well as for the additional ozonation stage were collected, aggregated and will now be presented as an absolute sum or in reference to the volume of wastewater treated [EUR/m<sup>3</sup><sub>treated</sub>].

**Capital costs for infrastructure**

Capital expenditure for the business-as-usual treatment is about 80.5 Mio. EUR and consists mainly of investment costs for technical equipment and a small share of costs due to factory and office equipment. In relation to these initial investment costs, the ozonation stage only causes additional 3.7% (3.27 Mio. CHF or ca. 3.0 Mio. EUR) to the investment costs then (Figure 5-15). These costs might be lower than usual for other WWTPs with comparable capacity due to the fact that, in this special case, sandfilters were already in place and there is no pumping required.

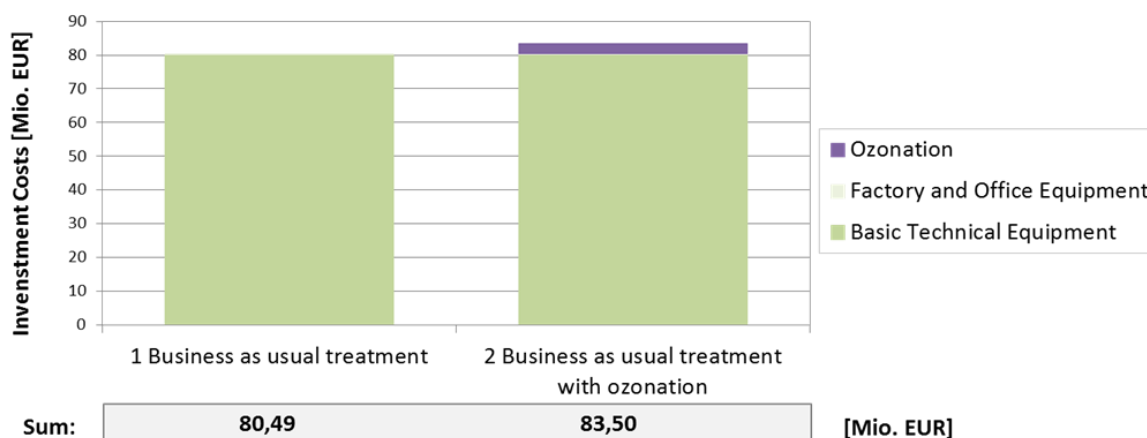

Figure 5-15: CAPEX for business-as-usual treatment and ozonation in Neugut



### Operational costs

Having a closer look at the operation of the Neugut plant (Figure 5-16), running costs are clearly dominated by personnel, electricity and capital interest. Operating an ozonation stage therefore increases the costs of operation by only 0.013 CHF/m<sup>3</sup> treated (~0.012 EUR/m<sup>3</sup> treated) which is an additional share of 6.3 % to the initial operating costs of 0.19 EUR/m<sup>3</sup> treated. These costs for additional energy, liquid oxygen, manpower and controlling are quite low compared to other WWTPs, because the recommended ozone dosing at Neugut plant is relatively small due to low DOC values after the biological treatment (2.0-3.3 mg/L ozone corresponding to 0.55 g ozone/g DOC)(McArdell et al. 2015). Nevertheless, the results state the impression that ozonation can be performed with a reasonable expense for operation as well.

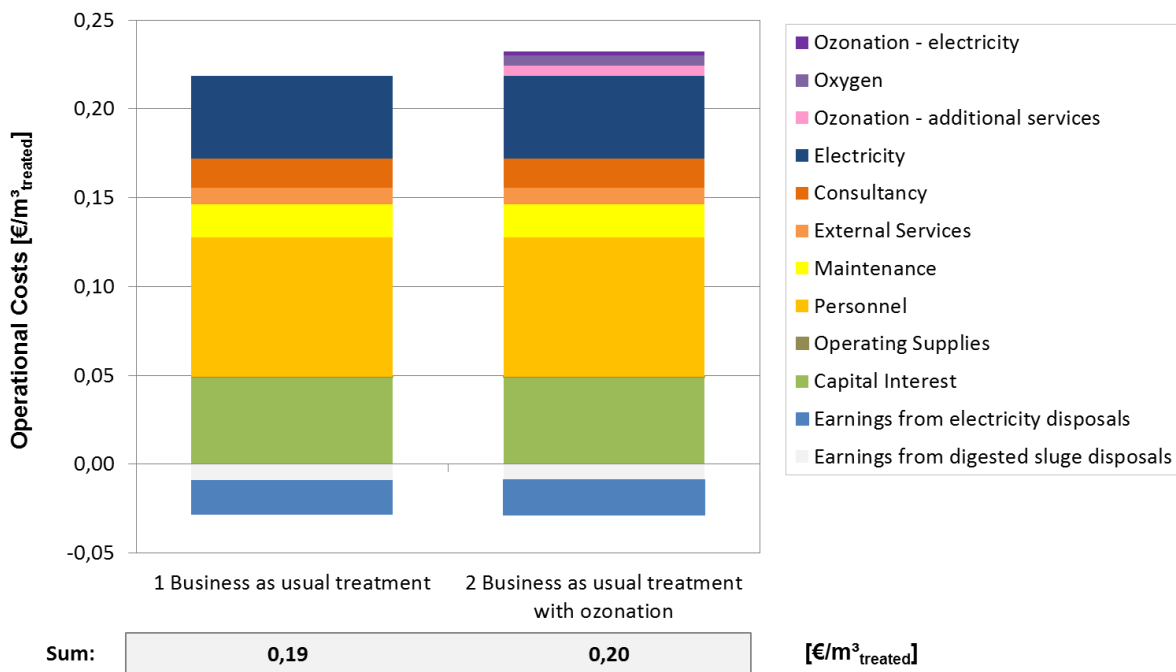

Figure 5-16: OPEX per m<sup>3</sup> treated water for business-as-usual treatment and ozonation in Neugut

### Net present value over the life cycle

Calculating the net present value over the estimated system life cycle of 30 years supports this impression: While the business-as-usual treatment already causes 153.7 Mio. EUR, costs for the wastewater treatment process with ozonation are negligible higher (159.7 Mio. EUR)(Figure 5-17). Based on the assumption that the WWTP will treat a constant amount of 8.6 Mio. m<sup>3</sup> wastewater annually within this 30 years, the costs per m<sup>3</sup> treated are calculated to be 0.60 EUR/m<sup>3</sup> treated for the business-as-usual treatment and 0.62 EUR/m<sup>3</sup> treated for the business-as-usual treatment with ozonation.

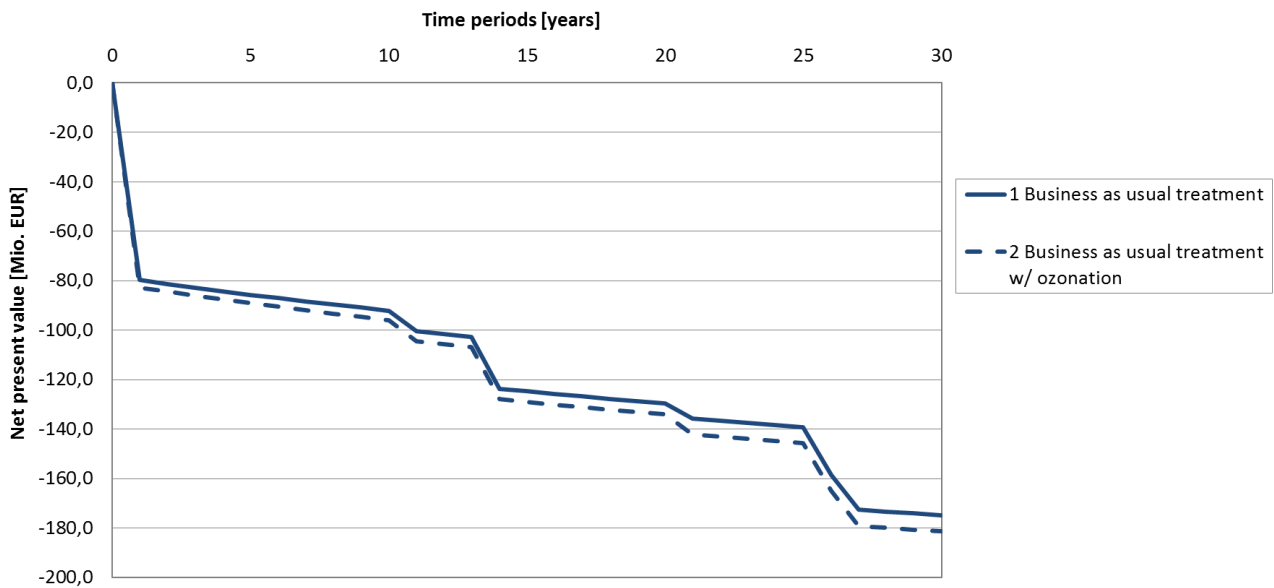

Figure 5-17: NPV of business-as-usual treatment and ozonation in Neugut over time

### Sensitivity analysis

Sensitivity analyses of the results prove that the results presented above are very robust against variations in the ozonation or overall system's lifetime (Figure 5-18:) as well as variations of inflation and discounting rates.

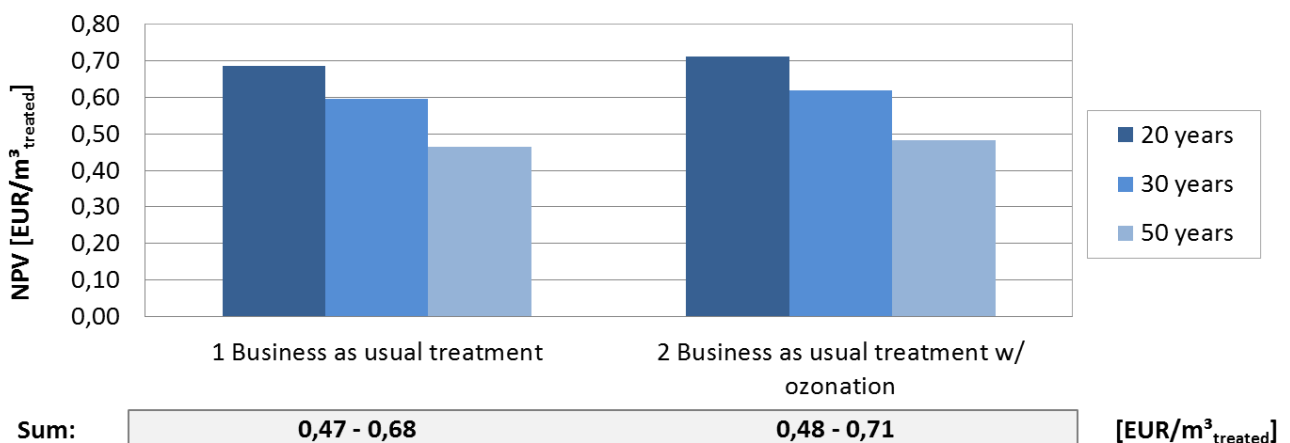

Figure 5-18: NPV per m<sup>3</sup> treated wastewater for business-as-usual treatment and ozonation in Neugut under varying system lifetimes

Table 5-4: NPV per m<sup>3</sup> treated wastewater for business-as-usual treatment and ozonation in Neugut under inflation and discount rates

	1 Business as usual treatment	2 Business as usual treatment w/ ozonation	additional costs for ozonation
discounting/ inflation	EUR/m <sup>3</sup> <sub>treated</sub>	EUR/m <sup>3</sup> <sub>treated</sub>	EUR/m <sup>3</sup> <sub>treated</sub>
i=3%, r=0%	0.60	0.62	0.03
i=5%, r=0%	0.52	0.54	0.02
i=7%, r=0%	0.46	0.48	0.02
i=3%, r=1%	0.61	0.64	0.02
i=3%, r=2%	0.63	0.66	0.03
i=3%, r=3%	0.66	0.68	0.03

with i = discounting rate and r = inflation rate (on energy, operating supplies and personnel costs)

### 5.3.4 Conclusions and Unique Selling Propositions

- USP1: Ozonation with subsequent biological sand filtration as last treatment stage in wastewater treatment provides an effective broadband elimination of emerging contaminants. The magnitude of environmental trade-offs depends mainly on the source of electric energy used.**

We performed an evaluation of the environmental impacts of the Neugut wastewater treatment plant extended with an ozonation system compared to the baseline scenario without ozonation. As global conclusions among all impact indicators, we calculated that the additional impact of the ozonation (mainly liquid oxygen and electricity production) adds from 0 to 10% of the impact among all categories compared to the baseline scenario. The main plant infrastructure contributes to a significant part of the impact for all impact categories (4 to 61%), followed by electricity consumption for the main plant operation (1 to 85%). In the wastewater treatment plant with or without ozonation system, there are benefits from sludge burning, as the dried sludge is used as fuel in cement plant, as a substitute for coal. The electricity requirements have a low impact on climate change (compared for example to Germany) given that Switzerland has less than 10% of its energy based on fossil fuels or coal.

(Eco)toxicity results showed that when considering only eleven monitored substances, the environmental benefit of ozonation is mainly visible for the human toxicity non-cancer effect (reduces 43% of the impact), the main contributors being primidone emissions for human toxicity, cancer effect, diclofenac emissions for human toxicity, non-cancer effect and diclofenac, followed by benzotriazole, and sulfamethoxazole emissions for freshwater ecotoxicity. These results are based on the assumption of a proportional effect between the amount of substance emitted and its toxic impact, which is key principle in LCA. In that sense, any substance that shows an effect on aquatic organisms or mammals in toxicity tests appear to contribute to the toxic impact, which is independent of legal thresholds used in risk assessment. LCA impact scores are indeed determined by the mass of emerging contaminant emitted, that contributes to relative changes in the concentrations of the emerging contaminants in the receiving water body. However, the absolute concentrations that are actually found in the receiving water are not considered in current models such as USEtox. These monitored substances cover a wide range of toxicity. When extrapolating the toxic impact to the entire emerging

contaminant load, the emerging contaminant emissions represent a significant contribution to the human health and freshwater ecotoxicity impact in case the toxicity of the emerging contaminant load is average to high, i.e. between the median and the 3<sup>rd</sup> quartile of organic substances CFs in USEtox. This confirms the relevance of using a emerging contaminant system by ozonation to protect both freshwater ecosystem in rivers and lakes that receive the effluent as well as humans that ingest emerging contaminants through drinking water and fish.

- **USP2: The additional ozonation can be installed and operated economically in existing WWTPs, especially if the conditions at the WWTP are favourable. Such cost saving conditions include a design allowing an operation without additional pumping requirements and the existence of a last biological filtration stage.**

Life cycle costing showed that adding an ozonation stage did in this specific case only required moderate investments: the initial investment costs for adding an ozonation system equals only 3.7 % of the plant's initial investment costs, whereas the operational costs, dominated by costs of electricity and oxygen, increase the initial operational costs by only 0.012 EUR/m<sup>3</sup><sub>treated</sub> (Table 5 5). Running an ozonation system can therefore be seen as a measure causing reasonable financial effort.

Table 5-5: Summary of LCC results for Neugut case study

<b>Life Cycle Costs</b>		
Investment cost [Mio. EUR]	80.5	83.5
Operational cost [EUR/m <sup>3</sup> <sub>treated</sub> ]	0.19	0.20
Total life cycle cost [EUR/m <sup>3</sup> <sub>treated</sub> ]	0.60	0.62

## 6 Bioassays

### 6.1 Technology description and relevant application areas

In-vitro bioassays are biological test systems that make use of e.g. mammalian cell lines. In vitro bioassays have been developed to suit the complex mixture characterization needs covering complex endpoints such as genotoxicity, mutagenicity and particularly endocrine disruption. The main advantage of in-vitro bioassays is the integration of biological activities of compounds in a complex mixture such as surface water. In-vitro bioassays are typically carried out on multiwell plates providing high-throughput analysis.

Bioassays can play an important role when dealing with emerging contaminants such as organic emerging contaminants: they assess the quality of a water sample using an effect-based approach. In contrast to chemical analysis measuring a defined selection of single substances, bioassays can be used for screening of samples towards a specific biological effect that is eventually triggered by the mixture of substances in the sample. Thus, bioassays are also capable to detect synergistic or antagonistic effects of complex mixtures, as well as cover the effects of “unidentified” substances which are not covered in the chemical analysis method.

### 6.2 Case studies conducted in DEMEAU

Within the DEMEAU project, selected in-vitro bioassays (Figure 6-1) have been tested at different sites on a variety of water samples. The testing included bioassays for oxidative stress response (AREc32, Nrf2 CALUX) and selected compounds of causing endocrine disruption. The goal was to test the reproducibility of the bioassay response and establish trigger values for evaluation of the response signal. Tested samples included a pilot installation of water treatment with ozone/activated carbon at Waternet (drinking water utility in NL), and also different sites of MAR within the DEMEAU consortium.

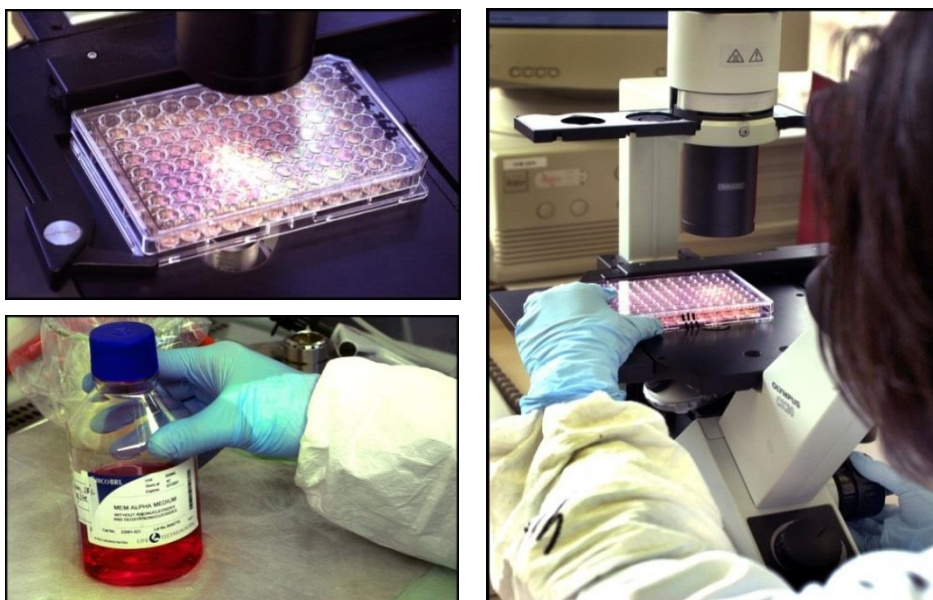

Figure 6-1: Bioassay analysis

### 6.3 CS4.1: In-vitro bioassays at Waternet (NL)

Specific in-vitro bioassays have been tested in their applicability for different purposes in drinking water treatment at Waternet (drinking water company in NL). A potential application for bioassays at Waternet could be the regular screening of source water quality and drinking water quality with an effect-based bioassay, and define a certain threshold of response (“trigger value”) above which a subsequent chemical analysis (LC-MS/MS) is required to identify potentially hazardous substances in the sample. Thus, frequent chemical analysis which is costly and laborious could be avoided by using bioassays as a screening indicator to decide on the necessity of detailed chemical analysis. For this case study, it has initially been planned to assess the use of in-vitro bioassays in a comparable approach as the water treatment technologies in work areas 1-3, applying both LCA and LCC in a comparative study. However, it was decided to modify the existing approach of LCA and LCC due to limitations in data availability and data quality.

For LCA, suitable inventory data for in-vitro bioassays and chemical analysis procedures could not be extracted from the existing lab protocols, as important substances could not be quantified in detail. In addition, both bioassays and chemical analysis make use of a wide selection of special organic and inorganic chemicals which are not characterized in the LCA database. From the discussion within WA5 and with the project partners, it became obvious that a validated inventory could not be produced without major efforts in data collection in the lab. Moreover, the environmental impact of sampling and analysis of water quality is estimated to be rather small (e.g. in terms of energy demand, carbon footprint etc.) compared to the actual processes of water treatment, thus making the additional efforts of a detailed LCA prohibitive in relation to the outcomes to be expected from the study. Finally, it was decided to skip a detailed LCA for this case study and rather provide a qualitative discussion of potential environmental impacts from bioassays and chemical analysis as a first proxy to discuss this innovative technology in its environmental profile.

For the LCC, the use of in-vitro bioassays can be interesting from an operator’s point of view in relation to the recurring costs of water analysis that may change when using the new approach. In addition, detailed cost data for bioassays and chemical analysis (e.g. cost and lifetime of equipment, personnel efforts, cost of chemicals, disposal of waste, etc.) could not be collected within the DEMEAU project. Hence, a simplified LCC is presented here taking the operator’s perspective, focussing on the real costs of water quality assessment for the water utility using the conventional strategy of chemical analysis or the innovative bioassay screening. This study can provide a first estimate of potential effects of using bioassays for water quality control on the analytical budget of a drinking water utility.

#### 6.3.1 Case study description

The quality of source water and drinking water is monitored regularly at Waternet in a broad chemical screening, following a defined schedule for sampling and chemical analysis (Table 3-6). In total, 73 samples are analysed annually with a defined set of chemical methods, checking for a list of pre-defined chemical substances and comparing them with threshold levels of concern.

For the DEMEAU case study, the following assessment focusses on the group of endocrine disrupting compounds, which encompass a list of 32 single substances analysed with LC-MS/MS. Using a respective bioassay (ER $\alpha$ -CALUX® from BioDetectionSystems/NL) and suitable threshold values, a water sample can be tested on the specific endocrine disrupting effect caused by these 32 substances or other emerging contaminants which have not yet been identified. In case of a positive signal of the bioassay screening (marking the existence of an endocrine disrupting compound above a certain threshold of concern), further analysis can be undertaken to identify and quantify the specific substance with chemical analysis.

**Table 6-1: Monitoring schedule of Waternet for broad chemical screening of water quality**

	Source water 1	Source water 2	Drinking water 1	Drinking water 2	TOTAL
No of samples per year	13	52	4	4	73
Frequency	Monthly	Weekly	Quarterly	Quarterly	

### 6.3.2 Qualitative LCA of bioassays

From an environmental perspective, the use of bioassays for quality control in drinking water production should have only marginal effects on the environment itself in terms of resource demand or emissions into air, water, and soil. The main potential impact of in-vitro bioassays or chemical analysis most probably relates to the energy and chemicals used for the analysis (e.g. for preparing the cells, storage, preparation of sample with solid-phase extraction, the actual exposure of the cells with the water sample, and subsequent automated analysis of the signals) and potential waste that is produced during the procedures.

Concerning the resource demand of in-vitro bioassays or LC-MS/MS, the production of specialty chemicals may be affected with higher energy demand than other bulk chemicals required in the lab. However, special chemicals are usually used in very low quantities (µg-range) during the analytical protocol, so that overall impacts are likely to be small. Energy demand for in-vitro bioassays may also be affected strongly by storing of cultivated ER-CALUX®-cells in liquid nitrogen, depending on the time of storage (weeks to months) and energy efficiency of the storage system. For conventional analysis, energy demand will probably depend on the electricity used for the LC system and the detector (MS/MS), plus the energy used for producing high-volume chemicals such as the mobile phase.

Direct emissions from the chemical analysis into the environment are not likely to occur in significant amounts. All solid or liquid chemical waste that may be hazardous to the environment will be disposed of in dedicated routes for hazardous substances, thus preventing major negative effects on the environment.

Overall, the environmental impact of chemical analysis or bioassays is estimated to contribute only marginally to the total energy and resource demand of water treatment. A more detailed analysis could only be based on “hands-on” data collection in the lab and precise definition of the systems to be compared, plus extensive analysis of production routes for specialty chemicals.

### 6.3.3 Cost assessment of bioassays

For the cost analysis, the following information has been provided by Waternet as input data:

- Net costs of chemical analysis (32 endocrine disrupting compounds) with LC-MS/MS: 620 € per sample
- Net costs of ERα-CALUX® bioassay: 80 € for solid phase extraction and 80 € for bioassay = 160 € per sample

In addition, the experts from Waternet estimate that a positive signal in the in-vitro bioassay could be expected in 10-25% of samples in a worst-case scenario, based on previous experience with

bioassays. Hence, these events would require a subsequent chemical analysis with LC-MS/MS to identify the cause of the positive signal in the bioassay.

Using this input data with the existing monitoring schedule of Waternet, the following analytical costs can be calculated from the operator’s perspective for different monitoring strategies (Table 6-2):

- 1) Regular chemical analysis with LC-MS/MS
- 2) Bioassay screening 1: regular screening with ERα-CALUX® bioassay and – in case of positive signal (10% of samples) – subsequent chemical analysis with LC-MS/MS
- 3) Bioassay screening 2: regular screening with ERα-CALUX® bioassay and – in case of positive signal (25% of samples) – subsequent chemical analysis with LC-MS/MS

**Table 6-2: Simplified cost assessment of traditional monitoring strategy and bioassay screening at Waternet (target effect: 32 substances causing endocrine disrupting effects)**

Net annual costs [€/yr.]	No of annual samples for LC-MS/MS	Cost for LC-MS/MS	No of annual samples for bioassays	Cost for bioassay	Total costs
Regular chemical analysis	73	45'260			45'260
Bioassay screening 1 (10% positive)	8	4'960	73	11'680	16'640
Bioassay screening 2 (25% positive)	19	11'780	73	11'680	23'460

From the simplified cost calculation, it becomes obvious that significant savings can be realized with the new strategy of using bioassays as screening for endocrine disrupting compounds. Depending on the ratio of positive signals in the screening, analytical costs for the operator can be reduced by 48-63% (21'800-28'620 EUR/yr.). In addition, endocrine disrupting chemicals which have not yet been included in the chemical analysis will be detected based on their effect on the cells during the bioassay, thus providing an additional indicator for emerging contaminants in this field. Naturally, this calculation is based on the precise and reproducible detection of endocrine disrupting effects in the ERα-CALUX® bioassay and the definition of suitable threshold values for marking a response as “positive signal”. Both aspects have been tested in DEMEAU in other tasks (D41.2) and are reported elsewhere (van der Linden et al. 2008, Brand et al. 2013).

**6.3.4 Conclusions and Unique Selling Propositions**

Bioassays can play an important role in dealing with emerging contaminants in the water cycle, complementing traditional chemical analysis of single substances with an effect-based test system. From the analysis of environmental and economic impacts, the following conclusions can be drawn:

- In general, monitoring processes are expected to add only marginal to energy and resource demand of drinking water treatment. Regarding potentially hazardous emissions, defined waste handling in the controlled lab environment should lead to negligible emissions into the environment or impacting on the lab staff. Overall, water sampling and analysis is not seen as a major contributor for environmental impacts of water treatment, but more data is required for a



definitive quantitative analysis of its environmental impacts.

- In the case study of Waternet, monitoring costs for endocrine disrupting compounds in source water and drinking water can be substantially reduced (minus 48-63%) if a specific bioassay for detection of endocrine disrupting effects is used for regular chemical screening. This example shows that bioassays may not only be an add-on for chemical analysis, but can be a valuable instrument in regular monitoring to decrease costs of highly complex analytical processes (such as LC-MS/MS) which are used to analyse an increasing number of individual substances.

## 7 Conclusions and summary of Unique Selling Propositions

Life Cycle Assessment (LCA) and Life Cycle Costing (LCC) were applied in order to characterize environmental and economic benefits and trade-offs of water treatment technologies against emerging contaminants. Together with relevant application areas of these technologies in drinking water treatment, wastewater treatment or in conjunction with managed aquifer recharge, we developed unique selling propositions (USPs) which highlight the main findings and characterize the relevant benefits of these technologies. Here the identified USPs for the different water technologies studied in the DEMEAU project are summarized.

### 7.1 Managed aquifer recharge (MAR)

Managed aquifer recharge (MAR) is rather an approach than a single technology making use of natural processes to fulfill a variety of functions for ecosystems and society:

- **USP1: Managed aquifer recharge provides multiple functions that could not be achieved by a single technological system including among others replenishment of groundwater resources, water storage, water quality improvements and water distribution.**

Different types of MAR exist and we have analysed a multi-barrier drinking water treatment scheme involving dune infiltration and a groundwater recharge scheme using pond infiltration. Dune infiltration at the case study site Dunea serves as a barrier for a variety of contaminants and helps maintaining the freshwater lens under the dunes to assure sufficient water supply and to prevent salt water intrusion.

- **USP2: Dune infiltration – a form of managed aquifer recharge - is a multi-functional barrier against contaminants with low energy and chemical requirements**

Similarly, the pond infiltration systems at the case study site Sant Vicenç dels Horts are inexpensive and contribute to sustain groundwater levels in the area:

- **USP3: Pond infiltration is a low-cost and low-energy groundwater recharge system with enhanced removal of organic emerging contaminants**

MAR can be extended by pre- and/or posttreatment in order to support these natural systems in the removal and/or degradation of emerging contaminants. At the dune infiltration in Dunea, several AOPs (Advanced Oxidation Processes) were tested at pilot scale. We found that:

- **USP4: Pre-treatment by Advanced Oxidation Processes (AOPs) for dune infiltration based on ozone and hydrogen peroxide can mitigate potential risks from emerging contaminants taking also advantage of the biologically active zone in the dune aquifer to further degrade possible transformation products of the oxidation**

Another approach which was tested in Sant Vicenç dels Horts involves the placement of an organic reactive layer above the aquifer in order to enhance the microbial degradation of emerging contaminants, which despite little operational requirements improves the quality of the infiltrated source water:

- **USP5: Low-cost and low-energy upgrade possible with organic layer to improve organic emerging contaminants removal**

## 7.2 Hybrid ceramic membrane filtration (HCMF) and Automatic Neural Net Control Systems (ANCS)

### 7.2.1 Hybrid ceramic membrane filtration (HCMF)

Hybrid Ceramic Membrane Filtration (HCMF) combining powdered activated carbon (PAC) adsorption with ultrafiltration (UF) can very effectively remove a broad spectrum of emerging contaminants from pre-treated wastewater or drinking water. Ceramic membranes have several advantages over more commonly used polymeric membranes, however their wider market uptake is still limited due to higher investment costs. Considering the whole lifecycle ceramic filtration costs a similar to polymeric filtration and ceramic membrane prices are expected to further drop with market uptake:

- **USP1: Over the lifecycle of a wastewater treatment plant hybrid ceramic membrane filtration (HCMF) is about as expensive as with polymeric membranes (HPMF).**

This is due to an expected longer lifetime of ceramic membranes leading to reduced replacement work and related investment and disposal costs compensating for the higher initial investment costs.

In terms of environmental performance, hybrid ceramic and polymeric membrane filtration in wastewater treatment against emerging contaminants is comparable with a small but not significant advantage for ceramic membranes:

- **USP2: The ecological performance of HCMF is slightly better than of HPMF, due to a smaller membrane area required and therewith related lower aeration requirements.**

Both HCMF and HPMF significantly reduce ecotoxicity and human toxicity potential of WWTP effluents due to the retention of emerging contaminants with environmental trade-offs related mainly to the PAC production:

- **USP3: The application of PAC in combination with ceramic or polymeric membrane filtration provides a highly effective broadband elimination of emerging contaminants with complete particle retention, disinfection properties and no by-products. On the other hand PAC production also causes noteworthy environmental impacts especially with regard to the global warming potential.**

The environmental profile should be improved thorough sensible sourcing and minimized PAC dosing by utilizing its maximum adsorption capacity and by exploring possible dosing optimization strategies with e.g. ANCS and/or bioassay applications. The sourcing and the use of regenerative PAC raw materials such as agricultural by-products (e.g. fruit stones and nut shells) may provide additional improvement opportunities.

### 7.2.2 Automatic Neural Net Control Systems (ANCS)

The performance of water treatment technologies depends on many different parameters which influence the treatment process and therewith optimal process settings. Automatic neural net control systems (ANCS) are process control systems which have been designed to find optimal settings depending on the simultaneous analysis of input parameters, optimization targets defined by the user, and specified boundary conditions such as water quality thresholds. ANCS can thus help to find favourable settings in terms of economic, operational and also environmental targets. Case studies in DEMEAU have shown that ANCS is a reasonable technology to reduce the electricity and chemicals demand for operation which affects both the environmental footprint and cost factors:

- **USP1: Optimisation of electricity and chemicals demand for operation with reasonable pay-back time. ANCS has been shown to be an effective approach to reduce electricity and chemicals demand for operation.**

Although the costs of ANCS implementation are strongly case specific, variable financing modes offered by the ANCS provider would ensure that a reasonable pay-back-time can be realized in most cases. Such savings could help to optimize the treatment capacity and for instance in a membrane based backwash system at a German drinking water treatment plant, ANCS has been able to reduce the number of chemically enhanced backwash cycles needed at pilot scale, so that the overall capacity of the existing plant may increase.

- **USP2: Capacity optimisation is possible. The cycles of chemically enhanced backwashes for membrane cleaning could be reduced in a drinking water treatment plant studied. An optimal use of the capacity resulting in reduced capacity requirements for future installations may be feasible.**

### 7.3 Advanced oxidation processes (AOPs)

Oxidative processes can be used to reduce emerging contaminant loads through the oxidation of a wide range of chemical structures. The chemical transformation in many cases eliminates deleterious effects of these contaminants, but the formation of unknown reaction products is an important issue. In the case of ozonation in wastewater treatment against emerging contaminants, the source of electricity such as fossil, nuclear etc. is the most important consideration with regard to environmental trade-offs:

- **USP1: Ozonation with subsequent biological sand filtration as last treatment stage in wastewater treatment provides an effective broadband elimination of emerging contaminants. The magnitude of with environmental trade-offs depending depends mainly on the source of electric energy used.**

The treatment costs over the lifecycle is strongly site specific and at the case study site in Switzerland favorable conditions were found:

- **USP2: An additional ozonation can be installed and operated economically in existing WWTPs, especially if the conditions at the WWTP are favourable. Cost saving opportunities include a design allowing an operation without additional pumping requirements and the existence of a last biological filtration stage.**

### 7.4 In-vitro bioassays

In-vitro bioassays can play an important role in dealing with emerging contaminants in the water cycle by complementing traditional physicochemical analysis of single target substances with an effect-based test system.

- **USP1: In-vitro bioassays for specific groups of compounds provide a cost-effective way of regular screening of water quality by substituting a significant number of expensive chemical analysis. Besides the reduction in monitoring costs for known substances, effect-based in-vitro bioassays give additional safety in water quality monitoring towards unknown or emerging compounds with potentially negative effects.**

The application of in-vitro bioassays is not expected to have significant environmental impacts in relation to the operation of water treatment systems.

- **USP2: The use of bioassays is not expected to cause any substantial negative environmental**

**impacts associated with required chemicals or materials compared to chemical analysis.**

In general, resource demand and related emissions caused by material and infrastructure for analytical techniques are expected to have only marginal contribution to the overall environmental impact of water treatment.

## 7.5 Conclusions

We believe that the applied unique selling propositions approach which combines environmental and economic assessments with an understanding of key application areas has permitted a transparent and concise way to assess and convey key messages. The environmental assessment at a mid-point rather than end-point level allowed highlighting specific strengths and weaknesses of each technology and could help defining the focus of future research. The unique selling propositions were further combined with insights from social drivers and barriers analyses in order to derive recommendations for impact in the water sector (Gross et al. 2015).

## 8 References

- Abegglen C, Siegrist H (2012a). Mikroverunreinigungen aus kommunalem Abwasser. Verfahren zur weitergehenden Elimination auf Kläranlagen. Bundesamt für Umwelt, Berne, Switzerland
- Abegglen C, Siegrist H (2012b). Mikroverunreinigungen aus kommunalem Abwasser. Verfahren zur weitergehenden Elimination auf Kläranlagen. In: Umwelt-Wissen 1241. Bundesamt für Umwelt, Berne, Switzerland
- AIB (2009). ARA Birs, Birsfelden. Amt für Industrielle Betriebe, Birsfelden, Switzerland
- AIB (2012). Jahresbericht Abwasser 2012. Amt für Industrielle Betriebe, Bau- und Umweltschutzdirektion, Kanton Basel-Landschaft, Liestal, Switzerland
- Asano T, Burton FL, Leverenz HL, Tsuchihashi R, Tchobanoglous G (2007). Groundwater recharge with reclaimed water. In: Water reuse: issues, technologies, and applications. Mc Graw Hill, New York, pp 1245–1302
- Bardtke, D., Müller, W. R. and Schäfer, C. (1994): Untersuchungen zur Optimierung der Denitrifikation hinsichtlich der Entwicklung von elementarem Stickstoff und Distickstoffoxid (Lachgas) (Investigations to optimize denitrification concerning the formation of elementary nitrogen and dinitrogenmonoxide). Umweltbundesamt, Berlin, Germany
- Bayer P, Heuer E, Karl U, Finkel M (2005). Economical and ecological comparison of granular activated carbon (GAC) adsorber refill strategies. *Water Res* 39:1719–28
- Brand W, de Jongh CM, van der Linden SC, Mennes W, Puijker LM, van Leeuwen CJ, van Wezel AP, Schriks M, Heringa MB (2013). Trigger values for investigation of hormonal activity in drinking water and its sources using CALUX bioassays. *Environ Int* 55:109–18
- Dillon P, Pavelic P, Page D, Beringen H, Ward J (2009). Managed aquifer recharge: an introduction. National Water Commission, Canberra, Australia
- ENSAT (2012). Enhancement of soil aquifer treatment to improve the quality of recharge water in the Llobregat river delta aquifer, available from: [www.life-ensat.eu](http://www.life-ensat.eu)
- Enwor (2015). Kundeninformation Trinkwasseranalyse, Probenahmestelle: Roetgen, TW Netzeinspeisung, Zeitraum: 01.04.2014-31.03.2015 (customer information drinking water analytics, sampling point Roetgen, input to drinking water supply network, period: 01.04.2013-31.03.2015). enwor, Herzogenrath, Germany. Available at: [www.enwor-vorort.de/de/Produkte/Trinkwasser/Trinkwasserqualitaet/Trinkwasserqualitaet/Wasser-Kundeninfo-Minimax-Analyse-Roetgen-bis-31.03.2015.pdf](http://www.enwor-vorort.de/de/Produkte/Trinkwasser/Trinkwasserqualitaet/Trinkwasserqualitaet/Wasser-Kundeninfo-Minimax-Analyse-Roetgen-bis-31.03.2015.pdf), last accessed on: 09 July 2015
- Gale I, Dillon P (2005). Managed aquifer recharge (MAR). UNESCO-IHP, Paris
- GE (2013). ZeeWeed\* Hollow-Fiber Membranes. Available from: <http://www.gewater.com/products/zeeweet-500-membrane.html>, last accessed on 2 March 2015

- Goedkoop M, Heijungs R, Huijbregts M, Schryver A de, Struijs J, Zelm R Van (2009). ReCiPe 2008, A life cycle impact assessment method which comprises harmonised category indicators at the midpoint and the endpoint level; Report I:Characterisation. Amersfoort, the Netherlands
- Hernandez Garcia M, Tobella J, Ortuno F, Armenta JL (2011). Aquifer recharge for securing water resources: The experience in Llobregat river. *Water Sci Technol* 63:220–226
- Hollender J, Zimmermann SG, Koepke S, Krauss M, McArdell CS, Ort C, Singer H, von Gunten U, Siegrist H (2009). Elimination of organic micropollutants in a municipal wastewater treatment plant upgraded with a full-scale post-ozonation followed by sand filtration. *Environ Sci Technol* 43:7862–7869
- Huijbregts M, Hauschild M, Joliet O, Margni M, McKone T, Rosenbaum RK, van de Meent D (2010). USEtox™ User manual. USEtox™ team publication, 1–23, available from: [www.usetox.org](http://www.usetox.org)
- Kanton Basel-Landschaft (2003). Bewilligung der Verpflichtungskredite für Erhalt und Ausbau der Abwasserreinigungsanlage Birs 2 in Birsfelden und für Massnahmen im Einzugsgebiet und die Erteilung des Enteignungsrechtes für Massnahmen im Einzugsgebiet (Bau Mischwasserbecken)
- Kanton Basel-Landschaft (2014). Kläranlagen in Basel-Landschaft. [www.umweltberichtbeiderbasel.ch/Klaeranlagen-in-Basel-Landschaft.221.0.html](http://www.umweltberichtbeiderbasel.ch/Klaeranlagen-in-Basel-Landschaft.221.0.html)
- Larsen HF, Hansen PA, Boyer-Souchet F (2010). Decision support guideline based on LCA and cost/efficiency assessment. Deliverable 4.3, EC Project “Neptune”
- Leckner B, Åmand L-E, Lücke K, Werther J (2004). Gaseous emissions from co-combustion of sewage sludge and coal/wood in a fluidized bed. *Fuel* 83:477–486
- Lehman SG, Liu L (2009). Application of ceramic membranes with pre-ozonation for treatment of secondary wastewater effluent. *Water Res* 43:2020–2028
- Lekkerkerker-Teunissen K (2012). Advanced oxidation and managed aquifer recharge a synergistic hybrid for organic micropollutant removal.
- Löwenberg J, Zenker A, Baggenstos M, Koch G, Kazner C, Wintgens T (2014). Comparison of two PAC/UF processes for the removal of micropollutants from wastewater treatment plant effluent: process performance and removal efficiency. *Water Res* 56:26–36
- Lüthy P (2014). Personal communication. Amt für Industrielle Betriebe, Liestal, Switzerland
- Margot J, Kienle C, Magnet A, Weil M, Rossi L, de Alencastro LF, Abegglen C, Thonney D, Chèvre N, Schärer M, Barry DA a (2013). Treatment of micropollutants in municipal wastewater: ozone or powdered activated carbon? *Sci Total Environ* 461-462:480–98
- Miret M, Vilanova E, Molinero J (2013). D12.1 Decision trees for MAR impact evaluation. Deliverable 12.1 from the DEMEAU project (FP 7 framework), <http://demeau-fp7.eu>
- Oberschelp C (2015). Sustainability assessment of micropollutant sequestration from pre-treated wastewater via hybrid ceramic membrane processing. Master thesis, RWTH Aachen University

and University of Applied Sciences and Arts Northwestern Switzerland (FHNW), Aachen, Germany and Muttenz, Switzerland

Park SH, Park YG, Lim J-L, Kim S (2015). Evaluation of ceramic membrane applications for water treatment plants with a life cycle cost analysis. *Desalin Water Treat* 54:973–979

Pfister S, Koehler A, Hellweg S (2009). Assessing the Environmental Impacts of Freshwater Consumption in LCA. *Environ Sci Technol* 43:4098–4104

Quantis (2011). Quantis Water Database. Available from: [www.quantis-intl.com/waterdatabase/software.php](http://www.quantis-intl.com/waterdatabase/software.php)

Ravazzini A, Miska V, Jansen H, de Koning J, Bixio D, Thoeye C, Karabelas AJ, Yiantsios S, Salgot M, Huertas Hidalgo E, Khan S, Dillon P, Schäfer A, Wintgens T, Koh CN, Cikurel H, Aharoni A (2006). Water treatment options in reuse systems. Aquarec deliverable D17, report to the European Commission

Remy C (2013). Life cycle assessment and life cycle costing of tertiary treatment schemes (OXERAM 2). Berlin, Germany

Remy C, Gallice A, Kounina A, Pieron M, Wencki K, Hugi C, Gross T (2015). Final guidelines for sustainability assessment of water technologies. Deliverable from the DEMEAU project (FP 7 framework), <http://demeau-fp7.eu>

Rosenbaum, R. K., Bachmann, T. M., Gold, L. S., Huijbregts, M. A. J., Jolliet, O., Juraske, R., Koehler, A., Larsen, H. F., MacLeod, M., Margni, M., McKone, T. E., Payet, J., Schuhmacher, M., van de Meent, D. and Hauschild, M. Z. (2008): USEtox-the UNEP-SETAC toxicity model: recommended characterisation factors for human toxicity and freshwater ecotoxicity in life cycle impact assessment. *International Journal of Life Cycle Assessment* 13 (7), 532-546.

Schwentner G (2011). Entfernung von Spurenstoffen mit Aktivkohle auf der Kläranlage Böblingen-Sindelfingen. Zweckverband Kläranlage Böblingen-Sindelfingen, Böblingen-Sindelfingen, Germany

Sterkele B, Gujer W (2009). Einsatz von Pulveraktivkohle zur Elimination von Mikroverunreinigungen aus dem Abwasser - 2. Zwischenbericht. Dübendorf, Switzerland

SUVA (2006). Factsheet Ozon. Schweizerische Unfallversicherungsanstalt, Luzern, Switzerland

Van der Linden SC, Heringa MB, Man H-Y, Sonneveld E, Puijker LM, Brouwer A, van der Burg B (2008). Detection of Multiple Hormonal Activities in Wastewater Effluents and Surface Water, Using a Panel of Steroid Receptor CALUX Bioassays. *Environ Sci Technol* 42:5814–5820

VDI (2012). VDI 4600: Cumulative energy demand -Terms, definitions, methods of calculation. Berlin, Germany

Vince F, Aoustin E, Bréant P, Marechal F (2008). LCA tool for the environmental evaluation of potable water production. *Desalination* 220:37–56



---

WWTP Neugut (2014). Switzerland's first facility for the removal of micropollutants. Wastewater treatment plant Neugut, Duebendorf, Switzerland

Yeow ML, Liu YT, Li K (2004). Morphological study of poly(vinylidene fluoride) asymmetric membranes: Effects of the solvent, additive, and dope temperature. *J Appl Polym Sci* 92:1782-1789

## Annex-A: Background data for case study CS1.1

Table A-1: Infrastructure inventory data

		MAR + post-treatment (S1)	O <sub>3</sub> /H <sub>2</sub> O <sub>2</sub> + MAR + post-treatment (S2)	O <sub>3</sub> /H <sub>2</sub> O <sub>2</sub> /UV + MAR + post-treatment (S3)	Lifetime
<b>Pipeline to dune (46 km, DN1400)</b>					
Concrete	t	89215	89215	89215	40a
Reinforcing steel	t	5451	5451	5451	40a
Cast iron	t	19240	19240	19240	40a
<b>Wells (1,000x)</b>					
Excavation	m <sup>3</sup>	5'000	5'000	5'000	40a
Concrete	m <sup>3</sup>				40a
<b>Drainage and collection system</b>					
HDPE	t	1'074	1'074	1'074	40a
PVC	t	4'700	4'700	4'700	40a
<b>Post-treatment train</b>					
<b>Rapid and slow sand filter</b>					
Concrete	t	26'000	26'000	26'000	40a
Reinforcing steel	t	9'364	9'364	9'364	40a
<b>Filter material</b>					
Sand	t	43'000	43'000	43'000	20a
Gravel	t	6'780	6'780	6'780	20a
<b>AOP system</b>					
Concrete	m <sup>3</sup>		3'160	3'160	40a
Reinforcing steel	t	-	422	422	40a
Stainless steel	t	-	685	685	40a
Granular activated carbon	t	-	110	110	20a
UV lamps (300W)	pc	-	-	5940	5a

Table A-2: LCA inventory data

Material or process	Dataset in Ecoinvent v2.2	Comment
<b>Excavation</b>	excavation, hydraulic digger [RER]	Density of soil: 1600 kg/m <sup>3</sup>
<b>Concrete</b>	concrete, exacting, with de-icing salt contact, at plant [CH]	Density: 2455 kg/m <sup>3</sup>
<b>Reinforcing steel</b>	reinforcing steel production [RER]	0.15 t/m <sup>3</sup> concrete
<b>Stainless steel</b>	chromium steel 18/8, at plant [RER]	
<b>PVC</b>	polyvinylchloride, at regional storage [RER]	
<b>HDPE</b>	polyethylene, HDPE, granulate, at plant [RER] + extrusion, plastic pipes [RER]	
<b>Sand</b>	silica sand, at plant [DE]	
<b>Gravel</b>	gravel, unspecified, at mine [CH]	
<b>Electricity</b>	electricity, medium voltage, at grid [NL]	Supply mix
<b>NaOH (50%)</b>	sodium hydroxide, 50% in H <sub>2</sub> O, membrane cell, at plant [RER]	
<b>Powdered activated carbon</b>	heat, natural gas, at industrial furnace low-NO <sub>x</sub> >100kW [RER]; electricity, high voltage, at grid [CN]; steam, for chemical processes, at plant [RER]; hard coal briquettes, at plant [RER]	For 1000 kg PAC: 9.828 GJ heat, 1.6 MWh electricity, 12 t steam, 86.7 MJ hard coal briquettes
<b>Granular activated carbon</b>	heat, natural gas, at industrial furnace low-NO <sub>x</sub> >100kW [RER]; electricity, high voltage, at grid [CN]; steam, for chemical processes, at plant [RER]; hard coal briquettes, at plant [RER]	Same material/energy demand for virgin GAC than for powdered AC, reactivation with 10% material loss.
<b>FeCl<sub>3</sub> (40%)</b>	iron (III) chloride, 40% in H <sub>2</sub> O, at plant [CH]	
<b>Liquid oxygen</b>	oxygen, liquid, at plant [RER]	
<b>H<sub>2</sub>O<sub>2</sub> (30%)</b>	hydrogen peroxide, 50% in H <sub>2</sub> O, at plant [RER]	Recalculated via concentr.
<b>UV lamps</b>	flat glass, uncoated, at plant [RER]; steel, low-alloyed, at plant [RER]; copper, primary, at refinery [RER]; mercury, liquid, at plant [GLO]	1 UV lamp (4kg): 96% glass, 2% steel, 2% Cu, 30 mg Hg
<b>Truck transport</b>	transport, lorry 16-32t, EURO5 [RER]	Concrete + steel: 30km, chemicals: 300km
<b>Disposal of reinforced concrete</b>	disposal, building, reinforced concrete, to sorting plant [CH]	
<b>Disposal of HDPE</b>	disposal, polyethylene, 0.4% water, to municipal incineration [CH]	
<b>Disposal of PVC</b>	disposal, polyvinylchloride, 0.2% water, to municipal incineration [CH]	
<b>Disposal of UV lamps</b>	disposal, fluorescent lamps [GLO]	

## Annex-B: Background data for case study CS1.2

Table B-1: LCA inventory data

	[units]	S1: MAR	S2: MAR + washing	S3: MAR + layer	S4: Scarification in river bed	S5: Scarification in channel	S6: Reference technology
<b>Construction</b>							
Excavation	m <sup>3</sup>	81813	81813	81813	-	23200	40
Concrete	m <sup>3</sup>	951	951	951	-	1330	754
Reinforcing steel	t	143	143	143	-	200	110
Sand	t	-	5040	-	-	-	-
Organic layer <sup>1</sup>	t	-	-	33603	-	-	-
<b>Operation</b>							
Topsoil moved <sup>2</sup>	t/yr.	4201	-	4201	-	-	-
Organic layer replaced	t/yr.	-	-	6723	-	-	-
Sand washing <sup>3</sup>	kWh/yr.	-	40320	-	-	-	-
Scarification machinery (8h/d)	d/yr.	-	-	-	50	30	-
Electricity	kWh/yr.	-	-	-	-	-	222000
Chemicals							
PACl (18% Al)	kg/yr.	-	-	-	-	-	60000
NaClO <sub>2</sub> (25%)							33600
Cl <sub>2</sub> (100%)							3600

<sup>1</sup> 60cm layer with 50% sand, 49% compost, 1% clay; replaced after 5 years

<sup>2</sup> 15 cm topsoil layer removed (scenario 1+3)

<sup>3</sup> 8 kWh/t sand for washing (data from MAR site Berlin)

Table B-2: Background datasets for LCA

Material or process	Dataset in Ecoinvent v2.2	Comment
Concrete	concrete production, normal [RoW]	Density: 2380 kg/m <sup>3</sup>
Reinforcing steel	reinforcing steel production [RER]	0.15 t/m <sup>3</sup> concrete
Clay	Clay, at mine [CH]	
Excavation	excavation, skid-steer loader [RER]	Density: 1600 kg/m <sup>3</sup>
Scarification	tillage, ploughing [CH]	1 ha = 2h scarification
Electricity	electricity, medium voltage, at grid [ES]	Supply mix
Polyaluminium chloride (PACl)	aluminium hydroxide, at plant [RER] + hydrochloric acid, 30% in H <sub>2</sub> O, at plant [RER] + electricity, medium voltage, at grid [ES]	1 kg PACl (18% Al): 0.34 kg AlOH <sub>3</sub> , 0,4 kg HCl (30%), 0.063 kWh

Material or process	Dataset in Ecoinvent v2.2	Comment
NaClO <sub>2</sub>	chlorine dioxide, at plant [RER]	1 kg NaClO <sub>2</sub> = 0.75 kg ClO <sub>2</sub>
Cl <sub>2</sub>	chlorine, liquid, production mix, at plant [RER]	
Truck transport	transport, freight, lorry 16-32 metric ton, EURO5 [RER]	Concrete + steel: 30km, chemicals: 300km
Disposal of reinforced concrete	disposal, building, reinforced concrete, to recycling [CH]	

RER: Europe, RoW: Rest of world, CH: Switzerland, ES: Spain

Table B-3: LCC inventory data

	[units]	S1: MAR	S2: MAR + washing	S3: MAR + layer	S4: Scarification in river bed	S5: Scarification in channel	S6: Reference technology
<b>Construction</b>							
Ponds, pipes	k€	1500	1500	1500	-	130	-
Sand layer	k€	-	37 <sup>1</sup>	-	-	-	-
Organic layer	k€	-	-	26	-	-	-
Piezometers	k€	62	62	62	35	35	35
Instrumentation	k€	20	20	20	20	20	20
Land area	k€	10	10	10	-	-	-
Pretreatment system + wells	k€	-	-	-	-	-	4390 <sup>2</sup> + 377
<b>Operation</b>							
Control + monitoring	k€/yr.	30	30	30	-	30	72
Machinery (contracting)	k€/yr.	5	5	5	37,5	22,5	-
Layer	k€/yr.	-	103	17	-	-	-
Analytics	k€/yr.	20	20	20	20	20	20
Electricity	k€/yr.	-	-	-	-	-	20
Chemicals	k€/yr.	-	-	-	-	-	45
Wells	k€/yr.	-	-	-	-	-	14

<sup>1</sup> 20k€ for sand layer, 17 k€ for washing machine

<sup>2</sup> 2260 k€ civil works, 2030 k€ machinery, 100 k€ electrical

<sup>3</sup> for sand washing

## Annex-C: Background data for case study CS2.1

Table C-1: LCA inventory data of the current WWTP Birs (per m<sup>3</sup> water treated)

Description	Amount	Process or substance	Comment
Antipyrine/ Phenazone emission to river water	$0.252 \times 10^{-6}$ kg	Phenazone	[110]
Atrazine emission to river water	$0.014 \times 10^{-6}$ kg	Atrazine	[14]
Bezafibrate emission to river water	$0.595 \times 10^{-6}$ kg	Bezafibrate	[14]
Bisphenole A emission to river water	$1.028 \times 10^{-6}$ kg	Bisphenole A	Measured at Birsfelden during LANCE project
BTZ emission to river water	4.4 mg	Benzotriazole	[21]
Caffeine emission to river water	$0.820 \times 10^{-6}$ kg	Caffeine	[14]
Carbendazim emission to river water	$0.132 \times 10^{-6}$ kg	Carbendazim	[14]
Chemical oxidation demand to water, river	6.910 g	COD, Chemical Oxygen Demand	[6]
CMZ emission to river water	1.1 mg	Carbamazepine	[21]
CO <sub>2</sub> emission to air	0.113kg	Carbon dioxide, biogenic	Sludge digestion and co-generation [6]
CO <sub>2</sub> emission to air	0.165 kg	Carbon dioxide, biogenic	Sludge incineration, calculated from stoichiometry [112]
DCF emission to river water	4.1 mg	Diclofenac	[21]
Diazepam emission to river water	$0.259 \times 10^{-6}$ kg	Diazepam	[110]
Diuron emission to river water	$0.070 \times 10^{-6}$ kg	Diuron	[14]
Electricity input	0.335 kWh	Electricity, low voltage, at grid/CH S	3740 MWh a <sup>-1</sup> for plant operation in 2012 [16]

Description	Amount	Process or substance	Comment
Electricity output	0.142 kWh	Electricity, low voltage, at grid/CH S	1589 MWh a <sup>-1</sup> from co-generation [16]
Estrone emission to river water	0.071 × 10 <sup>-6</sup> kg	Estrone	[14]
Ferric chloride input	0.0487 kg	Iron (III) chloride, 40% in H <sub>2</sub> O, at	212 t a <sup>-1</sup> dry FeCl <sub>3</sub> [16]
Gemfibrozil emission to river water	0.265 × 10 <sup>-6</sup> kg	Gemfibrozil	[14]
H <sub>2</sub> O emission to air	0.115 kg	Water	Sludge incineration, calculated from stoichiometry [112]
Heat input incineration	0.249 kWh	Heat, unspecific, in chemical plant/RER S	1.4 kWh kgTS <sup>-1</sup> for sludge drying at ProRhenon [69], 1987 tTS a <sup>-1</sup> in
Heat input plant	0.133 kWh	Heat, unspecific, in chemical plant/RER S	170 kW for process heat [5]
Heat output incineration	0.285 kWh	Heat, unspecific, in chemical plant/RER S	1.6 kWh kgTS <sup>-1</sup> from sludge incineration [69], 1987 tTS a <sup>-1</sup> in 2012 [16]
Heat output plant	0.603 kWh	Heat, unspecific, in chemical plant/RER S	769 kW from waste heat, heat pump and co-generation [5]
Ibuprofen emission to river water	0.952 × 10 <sup>-6</sup> kg	Ibuprofen	[14]
Iopromide emission to river water	4.141 × 10 <sup>-6</sup> kg	Iopromide	[14]
MCP emission to river water	0.4 mg	Diclofenac	[21]
Metoprolol emission to river water	0.653 × 10 <sup>-6</sup> kg	Metoprolol	[14]
Metronidazole emission to river water	0.567 × 10 <sup>-6</sup> kg	Metronidazole	[14]
Nitrogen emission to river water	4.987 g	Nitrogen, total Nitrogen total (Nitrogen	[6]
Organics emission to river water	6.619 g	DOC, Dissolved Organic Carbon	[6]

Description	Amount	Process or substance	Comment
Oxazepam emission to river water	0.350 × 10 <sup>-6</sup> kg	Oxazepam	[14]
Phosphorus emission to water, river	0.512 g	Phosphorus, total (Phosphorus for UBP	[6]
Plant infrastructure	6.28 × 10 <sup>-17</sup> pcs	Wastewater treatment plant, class 1/CH/I S	Adjusted to same p.e. treatment capacity, 30 years of lifetime estimated [5, 75]
Primidone emission to river water	0.097 × 10 <sup>-6</sup> kg	Primidone	[14]
Propiconazole emission to river water	0.040 × 10 <sup>-6</sup> kg	Propiconazole	[14]
SMX emission to river water	0.217 mg	Sulfamethoxazole	[21], median used instead of average because of irregular peak during
SO <sub>2</sub> emission to air	2.9 × 10 <sup>-3</sup> kg	Sulfur dioxide	Sludge incineration, calculated from stoichiometry [112]
Solid waste deposition	0.015 kg	Waste in inert landfill	Total suspended solids from mechanical treatment 2012 [16]
Solid waste deposition	0.091 kg	Waste in inert landfill	Ash from incineration 2012 [6]
Solids emission to water, river	6.111 g	Suspended solids, unspecified	[6]
Terbutryen emission to river water	0.019 × 10 <sup>-6</sup> kg	Terbutryen	[14]
Trimethoprim emission to river water	0.158 × 10 <sup>-6</sup> kg	Trimethoprim	[14]
Water emission to river water	0.032 kg	Water	For complete aqueous ferric chloride balance
Water emission to river water	1000 kg	Water	Functional unit



**Table C-2: LCA inventory data of the current WWTP Birs extended by the hypothetical full-scale hybrid ceramic membrane system (per m3 water treated)**

<b>Description</b>	<b>Amount</b>	<b>Process or substance</b>	<b>Comment</b>
Al <sub>2</sub> O <sub>3</sub> for membranes	2.24 × 10 <sup>-3</sup> kg	Aluminium oxide, at plant/RER S	20 kg per module, estimation derived from
Antipyrine/ Phenazone emission from hybrid ceramic membrane treatment	0.096 × 10 <sup>-6</sup> kg	Phenazone	62 % removal from PAC adsorption [110]
Atrazin emission to river water	0.004 × 10 <sup>-6</sup> kg	Atrazin	74 % removal from PAC adsorption [14]
Bezafibrate emission to river water	0.125 × 10 <sup>-6</sup> kg	Bezafibrate	79 % removal from PAC adsorption [14]
Bisphenole A emission to river water	0.175 × 10 <sup>-6</sup> kg	Bisphenole A	83 % removal from PAC adsorption [14]
BTZ emission to river water	0.044 × 10 <sup>-6</sup> kg	Benzotriazole	99 % removal [21]
Caffeine emission to river water	0.287 × 10 <sup>-6</sup> kg	Caffeine	65 % removal from PAC adsorption [14]
Carbendazim emission to river water	0.009 × 10 <sup>-6</sup> kg	Carbendazim	93 % removal from PAC adsorption [14]
Carboxymethyl cellulose for membranes	3.36 × 10 <sup>-5</sup> kg	Carboxymethyl cellulose, powder, at plant/RER S	0.015 kg per kg Al <sub>2</sub> O <sub>3</sub> [114]
Chromium steel for membrane towers	4.76 × 10 <sup>-4</sup> kg	Chromium steel 18/8, at plant/RER S	68 kg per tower, from data sheets [115]
Chromium steel for PAC dosing system	2.54 × 10 <sup>-5</sup> kg	Chromium steel 18/8, at plant/RER S	8.5 t per 125 m <sup>3</sup> AK-DOS PAC storage and
Chromium steel for pipes	2.59 × 10 <sup>-4</sup> kg	Chromium steel 18/8, at plant/RER S	86.9 t for pipes, based on normed pipe dimensions
CMZ emission to river water	0.077 × 10 <sup>-6</sup> kg	Carbamazepine	93 % removal [21]

Description	Amount	Process or substance	Comment
CO <sub>2</sub> emission anaerobic digestion to air	$5.82 \times 10^{-4}$ kg	Carbon dioxide, biogenic	0.316 m <sup>3</sup> biogas release per kg dry sludge input
CO <sub>2</sub> emission methane combustion to air	$3.17 \times 10^{-3}$ kg	Carbon dioxide, biogenic	Calculated from stoichiometry of methane
CO <sub>2</sub> emission PAC steam activation to air	$1.65 \times 10^{-1}$ kg	Carbon dioxide, fossil	11.0 kg per kg PAC, calculated from carbon
CO <sub>2</sub> emission PAC transportation to air	$3.75 \times 10^{-3}$ kg	Carbon dioxide, fossil	0.2-0.3 kg per kg PAC according to [24],
CO <sub>2</sub> emission to air	0.113 kg	Carbon dioxide, biogenic	Current sludge digestion and co-generation [6]
CO <sub>2</sub> emission to air	0.165 kg	Carbon dioxide, biogenic	Current sludge incineration, calculated
CO <sub>2</sub> emission waste incineration to air	$4.56 \times 10^{-2}$ kg	Carbon dioxide, biogenic	Calculated from sludge stoichiometry [112] and
COD emission to river water	$4.837 \times 10^{-3}$ kg	COD, Chemical Oxygen Demand	[6], 30% removal [66]
Concentrated NaOCl input	$4.55 \times 10^{-4}$ kg	Sodium hypochlorite, 15% in H <sub>2</sub> O, at plant/RER S	Has to be adjusted for water content, data from table 2.2
Concrete input	$3.62 \times 10^{-6}$ m <sup>3</sup>	Concrete, normal, at plant/CH S	1529 m <sup>3</sup> (898 m <sup>3</sup> for basins, 631 m <sup>3</sup> for sewers) based on
Current plant infrastructure	$6.28 \times 10^{-17}$ pcs	Wastewater treatment plant, class 1/CH/I S	Adjusted to same p.e. treatment capacity, 30 years of lifetime
DCF emission to river water	$0.984 \times 10^{-6}$ kg	Diclofenac	76% removal [21]
Diazepam emission to river water	$0.029 \times 10^{-6}$ kg	Diazepam	89% removal from PAC adsorption [110]
Distilled water for membranes	$1.49 \times 10^{-3}$ kg	Water, completely softened, at plant/RER S	0.4 kg per kg Al <sub>2</sub> O <sub>3</sub> [114]
Diuron emission to river water	$0.013 \times 10^{-6}$ kg	Diuron	82% removal from PAC adsorption [14]

Description	Amount	Process or substance	Comment
OC emission to river water	$4.633 \times 10^{-3}$ kg	DOC, Dissolved Organic Carbon	[6], 30% removal [21]
Electricity aeration biology	$1.12 \times 10^{-2}$ kWh	Electricity, low voltage, at grid/CH S	0.180 kWh per m <sup>3</sup> wastewater during biochemical treatment [6],
Electricity aeration membranes	$3.2031 \times 10^{-1}$ kWh	Electricity, low voltage, at grid/CH S	[118] at specific aeration rate of 0.3 m <sup>3</sup> m <sup>-2</sup> h <sup>-1</sup>
Electricity dewatering	$1.61 \times 10^{-3}$ kWh	Electricity, low voltage, at grid/CH S	0.6 kWh m <sup>-3</sup> [6]
Electricity input current plant	0.335 kWh	Electricity, low voltage, at grid/CH S	3740 MWh a <sup>-1</sup> for plant operation in 2012 [16]
Electricity input PAC production	$2.40 \times 10^{-2}$ kWh	Electricity, low voltage, at grid/NL S	1.6 kWh per kg PAC [23], validated by [25]
Electricity membrane production	$1.95 \times 10^{-2}$ kWh	Electricity, low voltage, at grid/DE S	8.72 kWh per kg Al <sub>2</sub> O <sub>3</sub> [119]
Electricity mixing	$5.19 \times 10^{-3}$ kWh	Electricity, low voltage, at grid/CH S	0.095 kWh m <sup>-3</sup> for PAC addition [84] and also
Electricity output cogeneration	$5.14 \times 10^{-3}$ kWh	Electricity, low voltage, at grid/CH S	2.4 kWh per m <sup>3</sup> biogas [16]
Electricity output current plant	0.142 kWh	Electricity, low voltage, at grid/CH S	1589 MWh a <sup>-1</sup> from cogeneration [16]
Electricity PAC dosing	$2.39 \times 10^{-4}$ kWh	Electricity, low voltage, at grid/CH S	0.0159 kWh per kg PAC [84]
Electricity pumping	$6.62 \times 10^{-2}$ kWh	Electricity, low voltage, at grid/CH S	Calculated from transportation heights according to [93], 70 % pumping efficiency [93], 10 % frictional losses assumed for static pressures B.8
Estrone emission to river water	$0.006 \times 10^{-6}$ kg	Estrone	92 % removal from PAC adsorption [14]
Excavation basins	$1.21 \times 10^{-5}$ m <sup>3</sup>	Excavation, hydraulic digger/RER S	4044 m <sup>3</sup> , based on dimensions of ceramic

Description	Amount	Process or substance	Comment
Excavation sewers	$8.27 \times 10^{-6} \text{ m}^3$	Excavation, hydraulic digger/RER S	5542 m <sup>3</sup> , based on dimensions of existing
Ferric chloride input	0.0487 kg	Iron (III) chloride, 40% in H <sub>2</sub> O, at plant/CH S	212 t a <sup>-1</sup> dry FeCl <sub>3</sub> [16]
Gemfibrozil emission to river water	$0.064 \times 10^{-6} \text{ kg}$	Gemfibrozil	76 % removal from PAC adsorption [14]
Gravel for foundations	$1.81 \times 10^{-3} \text{ kg}$	Gravel, crushed, at mine/CH S	731 t (483 t for basins, 248 t for sewers), based on dimensions of
H <sub>2</sub> O emission to air	0.115 kg	Water	Current sludge incineration, calculated
Hard coal input	$6.00 \times 10^{-2} \text{ kg}$	Hard coal supply mix/NL S	4 kg coal per kg PAC [25], concentration: 15 g
Heat demand anaerobic digestion	$5.30 \times 10^{-3} \text{ kWh}$	Heat, unspecific, in chemical plant/RER S	For heating sludge water content from 17.1 °C [6]
Heat demand incineration	$2.93 \times 10^{-2} \text{ kWh}$	Heat, unspecific, in chemical plant/RER S	1.4 kWh kgTS <sup>-1</sup> for sludge drying at
Heat input current incineration	0.249 kWh	Heat, unspecific, in chemical plant/RER S	1.4 kWh kgTS <sup>-1</sup> for sludge drying at
Heat input current plant	0.133 kWh	Heat, unspecific, in chemical plant/RER S	170 kW for process heat [5]
Heat loss co-generation to air	$1.29 \times 10^{-3} \text{ kWh}$	Heat, waste	0.6 kWh per m <sup>3</sup> biogas [16]
Heat output co-generation	$7.93 \times 10^{-3} \text{ kWh}$	Heat, unspecific, in chemical plant/RER S	3.7 kWh per m <sup>3</sup> biogas [16]
Heat output current incineration	0.285 kWh	Heat, unspecific, in chemical plant/RER S	1.6 kWh kgTS <sup>-1</sup> from sludge incineration [69], 1987 tTS a <sup>-1</sup> in 2012 [16]
Heat output current plant	0.603 kWh	Heat, unspecific, in chemical plant/RER S	769 kW from waste heat, heat pump and co-generation [5]
Heat output incineration	$3.34 \times 10^{-2} \text{ kWh}$	Heat, unspecific, in chemical plant/RER S	1.6 kWh kgTS <sup>-1</sup> from sludge incineration [69]

<b>Description</b>	<b>Amount</b>	<b>Process or substance</b>	<b>Comment</b>
Heat recovery from aeration	$2.46 \times 10^{-2}$ kWh	Heat, unspecific, in chemical plant/RER S	7.42 % of electricity input (17 kW for aeration of biology in current plant) [5]
Ibuprofen emission to river water	$0.162 \times 10^{-6}$ kg	Ibuprofen	83 % removal from PAC adsorption [14]
Injection moulding of PUR	$1.12 \times 10^{-3}$ kg	Injection moulding/RER S	Based on PUR mass of 10 kg per membrane module
Iopromide emission to river water	$2.195 \times 10^{-6}$ kg	Iopromide	47 % removal from PAC adsorption [14]
MCP emission to river water	$0.092 \times 10^{-6}$ kg	Mecoprop	77 % removal [21]
Metoprolol emission to river water	$0.033 \times 10^{-6}$ kg	Metoprolol	95 % removal from PAC adsorption [14]
Metronidazole emission to river water	$0.119 \times 10^{-6}$ kg	Metronidazole	79 % removal from PAC adsorption [14]
Natural gas input PAC production	$3.86 \times 10^{-2}$ kWh	Natural gas, burned in industrial furnace >100kW/RER S	0.28 m <sup>3</sup> per kg PAC [23] at heating value of 50 MJ kg <sup>-1</sup> and
Oxazepam emission to river water	$0.109 \times 10^{-6}$ kg	Oxazepam	69 % removal from PAC adsorption [14]
Primidone emission to river water	$0.048 \times 10^{-6}$ kg	Primidone	51 % removal from PAC adsorption [14]
Production of membrane towers	$4.76 \times 10^{-4}$ kg	Metal working factory operation, average heat energy/RER S	Based on steel mass of 68 kg per tower
Production of PAC dosing system	$2.54 \times 10^{-5}$ kg	Chromium steel product manufacturing, average metal working/RER S	Based on total mass of 8.5 t per AK-DOS PAC storage and dosing system
Production of pipes	$2.59 \times 10^{-4}$ kg	Chromium steel product manufacturing, average metal working/RER S	Based on total mass of 86.9 t for pipes

Description	Amount	Process or substance	Comment
Propiconazole emission to river water	$0.014 \times 10^{-6}$ kg	Propiconazole	66 % removal from PAC adsorption [14]
PUR for membrane modules	$1.12 \times 10^{-3}$ kg	Polyurethane, rigid foam, at plant/RER S	10 kg per module, estimation derived from
Reinforcing steel input	$2.72 \times 10^{-4}$ kg	Reinforcing steel, at plant/RER S	$75 \text{ kg m}^{-3}$ needed for concrete according to
Roads	$5.71 \times 10^{-5} \text{ m}^2$	Roads, company, internal/CH/I S	$637.5 \text{ m}^2$ total, estimation based on
Sheet rolling for membrane towers	$4.76 \times 10^{-4}$ kg	Sheet rolling, chromium steel/RER S	Based on steel mass of 68 kg per tower
SMX emission to river water	$0.100 \times 10^{-6}$ kg	Sulfamethoxazole	54 % removal [21], median used instead of
SO <sub>2</sub> emission incineration to air	$9.48 \times 10^{-5}$ kg	Sulfur dioxide	Calculated from sludge stoichiometry [112]
SO <sub>2</sub> emission to air	$2.9 \times 10^{-3}$ kg	Sulfur dioxide	Current sludge incineration, calculated from stoichiometry [112]
Sodium chloride emission to river water	$3.56 \times 10^{-4}$ kg	Sodium chloride	Oxidised NaOCl from chemical cleaning,
Solid waste deposition	0.015 kg	Waste in inert landfill	Total suspended solids from mechanical
Solid waste deposition	0.091	Waste in inert landfill	Ash from incineration
Solid waste disposal	$4.81 \times 10^{-3}$ kg	Waste in inert landfill	Calculated from sludge annealing loss of 55.6 wt.-% [6] and PAC SAE Super ash content of 12 wt.-% [14]
Steam input PAC production	$1.80 \times 10^{-1}$ kg	Steam, for chemical processes, at plant/RER S	12 kg steam per kg PAC [23], validated by [25]
Terbutryen emission to river water	$0.004 \times 10^{-6}$ kg	Terbutryen	80 % removal from PAC adsorption [14]

Description	Amount	Process or substance	Comment
TN emission to river water	$4.987 \times 10^{-3}$ kg	Nitrogen, total (Nitrogen for UBP calculation)	[6], 0 % removal [121]
TP emission to river water	$0.307 \times 10^{-3}$ kg	Phosphorus, total (for UBP calculation)	[6], 40 % removal [21]
Transportation membranes	$1.01 \times 10^{-3}$ t km	Transport, lorry >32t, EURO3/RER S	144 t km per membrane tower, distance Saarbrücken to Birsfelden:
Trimethoprim emission to river water	$0.009 \times 10^{-6}$ kg	Trimethoprim	94 % removal from PAC adsorption [14]
TSS emission to river water	$4.204 \times 10^{-3}$ kg	Suspended solids, unspecified	[6], 31.2 % removal for PAC system with
Water emission to air from PAC steam activation	$1.80 \times 10^{-1}$ kg	Water	12 kg water per kg PAC [23], validated by [25]
Water emission to river water	0.032 kg	Water	For complete aqueous ferric chloride balance
Water emission to river water	1000 kg	Water	Functional unit
Water emission to river water	$2.60 \times 10^{-3}$ kg	Water	From chemical cleaning, calculated from mass
Water emission waste incineration to air	$6.83 \times 10^{-2}$ kg	Water	Calculated from sludge stoichiometry [112] and
Water input for NaOCl dilution	$1.96 \times 10^{-8}$ kg	Water, unspecified natural origin, CH	Experimental NaOCl concentration is 13 %
Welding	$2.52 \times 10^{-5}$ m	Welding, arc, steel/RER S	Assumption: 3.6 m per membrane tower, on

Table C-3: LCC inventory data: capital expenditure (CAPEX)

Relevant scenario	Type of equipment	Amount	Specifications	Physical Lifetime	Costs	Source
a/b/c	Initial investment costs	1	-	-	43908537 EUR	Kanton Basel-Landschaft 2014
a/b	Building for equipment (incl. installation)	1	15 x 20 x 11.4 m	60 a	477803 EUR	Bitterli/Koch 2004
a	Ceramic system basins	7	379 m <sup>3</sup> , concrete	60 a	1256172 EUR	Schwentner 2011
b	Polymeric system basins	6	433 m <sup>3</sup> , concrete	60 a	1275460 EUR	Schwentner 2011
a/b	Sewer system (incl. installation)	1	251 m, concrete	60 a	1747778 EUR	Schwentner 2011
a/b	Cleaning chemical mixing vessel	1	10 m <sup>3</sup> , 0.95 kW, stainless steel	30 a	464647 EUR	Seider et al. 2010
a/b	PAC dosing system	1	125 m <sup>3</sup>	30 a	443063 EUR	Schwentner 2011
a/b	Pipes 0.0483 m diameter (incl. installation)	1	2120 m, stainless steel, for sprinkler	30 a	461710 EUR	Perry et al. 1997
a/b	Pipes 0.0603 m diameter (incl. installation)	1	70 m, stainless steel	30 a	11027 EUR	Perry et al. 1997
a/b	Pipes 0.1143 m diameter (incl. installation)	1	30 m, stainless steel	30 a	11063 EUR	Perry et al. 1997
a/b	Pipes 0.2191 m diameter (incl. installation)	1	100 m, stainless steel	30 a	87618 EUR	Perry et al. 1997
a/b	Pipes 0.508 m diameter (incl. installation)	1	110 m, stainless steel	30 a	294937 EUR	Perry et al. 1997
a/b	Pipes 0.508 m diameter (incl. installation)	1	200 m, stainless steel	30 a	536249 EUR	Perry et al. 1997
a/b	Pipes 0.61 m diametern	1	10 m, stainless steel	30 a	34200 EUR	Perry et al. 1997
a/b	Streets (incl. installation)	1	637.5 m <sup>2</sup> , 8.5 x 75 m	30 a	59930 EUR	Stadt Köln 2010
a/b	Blowers (incl. installation)	4	250 kW, aluminium	15 a	216656 EUR	Seider et al. 2010
a/b	Cleaning chemical pumps (incl. installation)	2	10 L s <sup>-1</sup>	15 a	19031 EUR	Seider et al. 2010
a/b	Drain pumps (to buffer tank) (incl. installation)	3	25 L s <sup>-1</sup>	15 a	30366 EUR	Seider et al. 2010
a/b	Drain pumps (to drain buffer) (incl. installation)	3	25 L s <sup>-1</sup>	15 a	28612 EUR	Seider et al. 2010
a/b	Membrane pumps (incl. installation)	8	200 L s <sup>-1</sup> , reversible gear	15 a	142876 EUR	Seider et al. 2010
a/b	Pumps retention to membranes (incl. installation)	2	250 L s <sup>-1</sup>	15 a	28651 EUR	Seider et al. 2010
a/b	Pumps retention to membranes (incl. installation)	2	500 L s <sup>-1</sup>	15 a	35981 EUR	Seider et al. 2010
a/b	Sprinkler pumps (incl. installation)	2	25 L s <sup>-1</sup>	15 a	19491 EUR	Seider et al. 2010



Relevant scenario	Type of equipment	Amount	Specifications	Physical Lifetime	Costs	Source
a/b	Mixer PAC mixing (incl. installation)	1	2.28 kW	15 a	8621 EUR	Seider et al. 2010
a/b	Mixers pre-biological basins (incl. installation)	4	0.43 kW	15 a	13921 EUR	Seider et al. 2010
a/b	Mixers retention basins (incl. installation)	4	0.41 kW	15 a	13699 EUR	Seider et al. 2010
a	Ceramic membranes (incl. installation & deposition)	1	60928 m <sup>3</sup>	12 a	11987610 EUR	Sawatzki 2014, Der Schweizerische Bundesrat 2008, Mülhauser 2012, Senn AG 2013
b	Polymeric membranes (incl. Installation & deposition)	1	102752 m <sup>3</sup>	7 a	7725437 EUR	Wintgens 2014, Der Schweizerische Bundesrat 2008, Mülhauser 2012, Senn AG 2013
a/b	Process Control System (incl. installation)	-	-	-	103870 EUR	Bitterli/Koch 2004
a/b	Planning	-	-	-	498447 EUR	Schwentner 2011

Table C-4: LCC inventory data: Operational expenditure (OPEX)

Relevant scenario	Cost Type	Amount	Specifications	Annual Costs	Source
a	Energy costs aeration	3701125 kWh	0.098 EUR kWh <sup>-1</sup>	360965 EUR	Lüthy 2014
b	Energy costs aeration	5503117 kWh	0.098 EUR kWh <sup>-1</sup>	536711 EUR	Lüthy 2014
a/b	Energy costs dewatering	17933 kWh	0.098 EUR kWh <sup>-1</sup>	1749 EUR	Lüthy 2014
a	Energy costs mixing	57892 kWh	0.098 EUR kWh <sup>-1</sup>	5646 EUR	Lüthy 2014
b	Energy costs mixing	64542 kWh	0.098 EUR kWh <sup>-1</sup>	6295 EUR	Lüthy 2014
a/b	Energy costs PAC dosing	2658 kWh	0.098 EUR kWh <sup>-1</sup>	259 EUR	Lüthy 2014
a	Energy costs pumping	738808 kWh	0.098 EUR kWh <sup>-1</sup>	72055 EUR	Lüthy 2014
b	Energy costs pumping	622158 kWh	0.098 EUR kWh <sup>-1</sup>	60678 EUR	Lüthy 2014
a	NaOCl costs	39129 kg	0.34 EUR kg <sup>-1</sup>	13356 EUR	Ulshöfer 2014
b	NaOCl costs	13593 kg	0.34 EUR kg <sup>-1</sup>	4640 EUR	Ulshöfer 2014
a/b	PAC costs	167440 kg	1.95 EUR kg <sup>-1</sup>	326603 EUR	Muller 2013
a/b	Revenue electricity production	57443 kWh	- 0.11 EUR kWh <sup>-1</sup>	- 6373 EUR	Der Schweizerische Bundesrat 1998
a	Revenue net heat production	320774 kWh	- 0.07 EUR kWh <sup>-1</sup>	- 22238 EUR	IWB 2014

Relevant scenario	Cost Type	Amount	Specifications	Annual Costs	Source
b	Revenue net heat production	454537 kWh	- 0.07 EUR kWh <sup>-1</sup>	- 31511 EUR	IWB 2014
a/b	Sludge incineration costs	233355 kg	0.49 EUR kg <sup>-1</sup>	113794 EUR	Lüthy 2014
a/b	Sludge transportation costs	922 m <sup>3</sup>	8.13 EUR m <sup>-3</sup>	7496 EUR	Bitterli/Koch 2004
a/b	Salaries and wages	-	-	27816 EUR	Mülhauser 2012, Schwentner 2011
a/b	Social security costs	-	Additional 9.83% on wages to pay by employer	2733 EUR	BSV 2014a, BSV 2014b, KSUV 2014, Koordination Schweiz GmbH 2014, WEKA Business Media AG 2014

## Annex-D: Background data for case study CS31

Table D-1: LCA inventory data of the Neugut WWTP without ozonation

Category	Material or process	Dataset in Ecoinvent v2.2	Comment
Avoided products	Avoided heat from coal production	Heat, at hard coal industrial furnace 1-10MW/RER U	Avoided heat from coal production, replaced by heat from sludge burning. 4 MJ / kg LHV of digested wet sludge with 50% dry solid. <a href="http://www.waterleau.com/files/Integrated_sludge_treatment.pdf">http://www.waterleau.com/files/Integrated_sludge_treatment.pdf</a>
Materials/fuels	Iron chloride	Iron (III) chloride, 40% in H2O, at plant/CH U	
	Emissions from burned biogas	biogas, burned in cogen with gas engine - created for DEMEAU/CH U	62% methane from collected data. LHV methane: 35.8 MJ/m3 from <a href="http://en.citizendium.org/wiki/Heat_of_combustion">http://en.citizendium.org/wiki/Heat_of_combustion</a>
	Wastewater treatment plant infrastructure	Wastewater treatment plant, class 2/CH/I U	Annual volume treated: 14'400'000 m3/year. Estimated lifetime: 30 years. Values based on ecoinvent to bring the process /m3.
	Flocculant	Chemicals organic, at plant/GLO U	
	Incineration of sewage sludge	Disposal, Neugut sewage sludge, 8% water, to municipal incineration/CH U	
	Electricity for main plant operation (from grid)	Electricity, low voltage, at grid/CH U	
Emissions to air	Dinitrogen monoxide	Dinitrogen monoxide	
	Ammonia	Ammonia	
Emissions to water	Nitrate	Nitrate	
	Phosphate	Phosphate	
	Ammonium, ion	Ammonium, ion	
	Nitrite	Nitrite	
	Bezafibrate	Bezafibrate	
	Benzotriazole	Benzotriazole	

Category	Material or process	Dataset in Ecoinvent v2.2	Comment
	Carbamazepine	Carbamazepine	
	Diclofenac	Diclofenac	
	Iopromide	Iopromide	
	Metoprolol	metoprolol	
	Antipyrine	Antipyrine	
	Primidone	Primidone	
	Sulfamethoxazole	Sulfamethoxazole	
	Trimethoprim	Trimethoprim	
	Mecoprop	Mecoprop	

Table D-2: LCA inventory data of the Neugut WWTP extended by ozonation

Category	Material or process	Dataset in Ecoinvent v2.2	Comment
Avoided products	Avoided heat from coal production	Heat, at hard coal industrial furnace 1-10MW/RER U	Avoided heat from coal production, replaced by heat from sludge burning. 4 MJ / kg LHV of digested wet sludge with 50% dry solid. <a href="http://www.waterleau.com/files/Integrated_sludge_treatment.pdf">http://www.waterleau.com/files/Integrated_sludge_treatment.pdf</a>
Materials/fuels	Iron chloride	Iron (III) chloride, 40% in H2O, at plant/CH U	
	Emissions from burned biogas	biogas, burned in cogen with gas engine - created for DEMEAU/CH U	62% methane from collected data. LHV methane: 35.8 MJ/m3 from <a href="http://en.citizendium.org/wiki/Heat_of_combustion">http://en.citizendium.org/wiki/Heat_of_combustion</a>
	Wastewater treatment plant infrastructure	Wastewater treatment plant, class 2/CH/I U	Annual volume treated: 14'400'000 m3/year. Estimated lifetime: 30 years. Values based on ecoinvent to bring the process /m3.
	Liquid oxygen	Oxygen, liquid, at plant/RER U	
	Reinforcing steel for ozonation system infrastructure	Reinforcing steel, at plant/RER U	
	Chromium steel for ozonation system infrastructure	Chromium steel 18/8, at plant/RER U	
Concrete for ozonation system infrastructure	Concrete, normal, at plant/CH U	Density concrete from ecoinvent: 2'380 kg/m3	

Category	Material or process	Dataset in Ecoinvent v2.2	Comment
	Flocculant	Chemicals organic, at plant/GLO U	
	Incineration of sewage sludge	Disposal, Neugut sewage sludge, 8% water, to municipal incineration/CH U	
	Electricity for main plant operation (from grid)	Electricity, low voltage, at grid/CH U	
	Electricity for ozonation (from grid)	Electricity, low voltage, at grid/CH U	
Emissions to air	Dinitrogen monoxide	Dinitrogen monoxide	
	Ammonia	Ammonia	
Emissions to water	Nitrate	Nitrate	
	Phosphate	Phosphate	
	Ammonium, ion	Ammonium, ion	
	Nitrite	Nitrite	
	Bezafibrate	Bezafibrate	
	Benzotriazole	Benzotriazole	
	Carbamazepine	Carbamazepine	
	Diclofenac	Diclofenac	
	Iopromide	Iopromide	
	Metoprolol	metoprolol	
	Antipyrine	Antipyrine	
	Primidone	Primidone	
	Sulfamethoxazole	Sulfamethoxazole	
	Trimethoprim	Trimethoprim	
Mecoprop	Mecoprop		

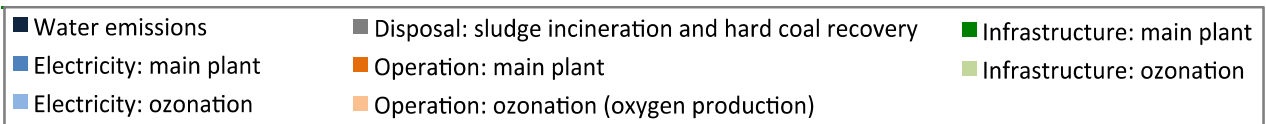
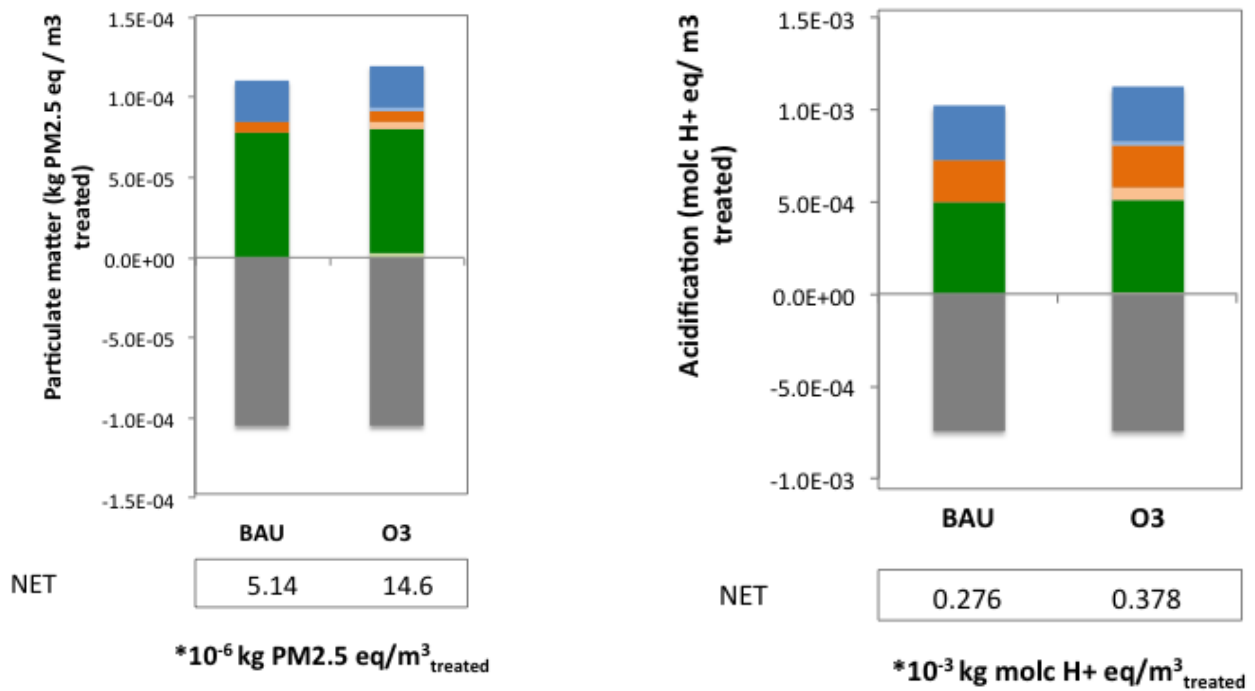

Figure D-1: Contribution to particulate matter and terrestrial acidification of BAU and O3 scenarios

Table D-3: LCC inventory data: capital expenditure (CAPEX)

Relevant scenario	Type of equipment	Amount	Specifications	Physical Lifetime	Costs	Source
a/b/c	Initial investment costs	1	-	-	43908537 EUR	Kanton Basel-Landschaft 2014
a/b	Building for equipment (incl. installation)	1	15 x 20 x 11.4 m	60 a	477803 EUR	Bitterli/Koch 2004
a	Ceramic system basins	7	379 m <sup>3</sup> , concrete	60 a	1256172 EUR	Schwentner 2011
b	Polymeric system basins	6	433 m <sup>3</sup> , concrete	60 a	1275460 EUR	Schwentner 2011
a/b	Sewer system (incl. installation)	1	251 m, concrete	60 a	1747778 EUR	Schwentner 2011
a/b	Cleaning chemical mixing vessel	1	10 m <sup>3</sup> , 0.95 kW, stainless steel	30 a	464647 EUR	Seider et al. 2010
a/b	PAC dosing system	1	125 m <sup>3</sup>	30 a	443063 EUR	Schwentner 2011
a/b	Pipes 0.0483 m diameter (incl. installation)	1	2120 m, stainless steel, for sprinkler	30 a	461710 EUR	Perry et al. 1997
a/b	Pipes 0.0603 m diameter (incl. installation)	1	70 m, stainless steel	30 a	11027 EUR	Perry et al. 1997

Relevant scenario	Type of equipment	Amount	Specifications	Physical Lifetime	Costs	Source
a/b	Pipes 0.1143 m diameter (incl. installation)	1	30 m, stainless steel	30 a	11063 EUR	Perry et al. 1997
a/b	Pipes 0.2191 m diameter (incl. installation)	1	100 m, stainless steel	30 a	87618 EUR	Perry et al. 1997
a/b	Pipes 0.508 m diameter (incl. installation)	1	110 m, stainless steel	30 a	294937 EUR	Perry et al. 1997
a/b	Pipes 0.508 m diameter (incl. installation)	1	200 m, stainless steel	30 a	536249 EUR	Perry et al. 1997
a/b	Pipes 0.61 m diameter	1	10 m, stainless steel	30 a	34200 EUR	Perry et al. 1997
a/b	Streets (incl. installation)	1	637.5 m <sup>2</sup> , 8.5 x 75 m	30 a	59930 EUR	Stadt Köln 2010
a/b	Blowers (incl. installation)	4	250 kW, aluminium	15 a	216656 EUR	Seider et al. 2010
a/b	Cleaning chemical pumps (incl. installation)	2	10 L s <sup>-1</sup>	15 a	19031 EUR	Seider et al. 2010
a/b	Drain pumps (to buffer tank) (incl. installation)	3	25 L s <sup>-1</sup>	15 a	30366 EUR	Seider et al. 2010
a/b	Drain pumps (to drain buffer) (incl. installation)	3	25 L s <sup>-1</sup>	15 a	28612 EUR	Seider et al. 2010
a/b	Membrane pumps (incl. installation)	8	200 L s <sup>-1</sup> , reversible gear	15 a	142876 EUR	Seider et al. 2010
a/b	Pumps retention to membranes (incl. installation)	2	250 L s <sup>-1</sup>	15 a	28651 EUR	Seider et al. 2010
a/b	Pumps retention to membranes (incl. installation)	2	500 L s <sup>-1</sup>	15 a	35981 EUR	Seider et al. 2010
a/b	Sprinkler pumps (incl. installation)	2	25 L s <sup>-1</sup>	15 a	19491 EUR	Seider et al. 2010
a/b	Mixer PAC mixing (incl. installation)	1	2.28 kW	15 a	8621 EUR	Seider et al. 2010
a/b	Mixers pre-biological basins (incl. installation)	4	0.43 kW	15 a	13921 EUR	Seider et al. 2010
a/b	Mixers retention basins (incl. installation)	4	0.41 kW	15 a	13699 EUR	Seider et al. 2010
a	Ceramic membranes (incl. installation & deposition)	1	60928 m <sup>3</sup>	12 a	11987610 EUR	Sawatzki 2014, Der Schweizerische Bundesrat 2008, Mülhauser 2012, Senn AG 2013
b	Polymeric membranes (incl. Installation & deposition)	1	102752 m <sup>3</sup>	7 a	7725437 EUR	Wintgens 2014, Der Schweizerische Bundesrat 2008, Mülhauser 2012, Senn AG 2013
a/b	Process Control System (incl. installation)	-	-	-	103870 EUR	Bitterli/Koch 2004
a/b	Planning	-	-	-	498447 EUR	Schwentner 2011

Table D-4: LCC inventory data: operational expenditure (OPEX)

Relevant scenario	Cost Type	Amount	Specifications	Annual Costs	Source
a	Energy costs aeration	3701125 kWh	0.098 EUR kWh <sup>-1</sup>	360965 EUR	Lüthy 2014
b	Energy costs aeration	5503117 kWh	0.098 EUR kWh <sup>-1</sup>	536711 EUR	Lüthy 2014
a/b	Energy costs dewatering	17933 kWh	0.098 EUR kWh <sup>-1</sup>	1749 EUR	Lüthy 2014
a	Energy costs mixing	57892 kWh	0.098 EUR kWh <sup>-1</sup>	5646 EUR	Lüthy 2014
b	Energy costs mixing	64542 kWh	0.098 EUR kWh <sup>-1</sup>	6295 EUR	Lüthy 2014
a/b	Energy costs PAC dosing	2658 kWh	0.098 EUR kWh <sup>-1</sup>	259 EUR	Lüthy 2014
a	Energy costs pumping	738808 kWh	0.098 EUR kWh <sup>-1</sup>	72055 EUR	Lüthy 2014
b	Energy costs pumping	622158 kWh	0.098 EUR kWh <sup>-1</sup>	60678 EUR	Lüthy 2014
a	NaOCl costs	39129 kg	0.34 EUR kg <sup>-1</sup>	13356 EUR	Ulshöfer 2014
b	NaOCl costs	13593 kg	0.34 EUR kg <sup>-1</sup>	4640 EUR	Ulshöfer 2014
a/b	PAC costs	167440 kg	1.95 EUR kg <sup>-1</sup>	326603 EUR	Muller 2013
a/b	Revenue electricity production	57443 kWh	- 0.11 EUR kWh <sup>-1</sup>	- 6373 EUR	Der Schweizerische Bundesrat 1998
a	Revenue net heat production	320774 kWh	- 0.07 EUR kWh <sup>-1</sup>	- 22238 EUR	IWB 2014
b	Revenue net heat production	454537 kWh	- 0.07 EUR kWh <sup>-1</sup>	- 31511 EUR	IWB 2014
a/b	Sludge incineration costs	233355 kg	0.49 EUR kg <sup>-1</sup>	113794 EUR	Lüthy 2014
a/b	Sludge transportation costs	922 m <sup>3</sup>	8.13 EUR m <sup>3</sup>	7496 EUR	Bitterli/Koch 2004
a/b	Salaries and wages	-	-	27816 EUR	Mülhauser 2012, Schwentner 2011
a/b	Social security costs	-	Additional 9.83% on wages to pay by employer	2733 EUR	BSV 2014a, BSV 2014b, KSUV 2014, Koordination Schweiz GmbH 2014, WEKA Business Media AG 2014



Table D-5: LCC input data

		Business-as-usual	Business as usual + ozonation
<b>Construction</b>			
Basic technical equipment	k€	80,186	80,186
Other assets	k€	300	300
Ozonation	k€	-	1,954
<b>Operation</b>			
Electricity	k€/yr.	400	400
Earnings from electricity disposals	k€/yr.	-170	-170
Earnings from digested sludge disposals	k€/yr.	-76	-76
Operating Supplies	k€/yr.	2	2
Personnel	k€/yr.	677	677
Maintenance	k€/yr.	160	160
External Services	k€/yr.	80	80
Consultancy	k€/yr.	140	140
Capital Interest	k€/yr.	420	420
Ozonation - additional services	k€/yr.	-	50
Ozonation - electricity	k€/yr.	-	20
Ozonation - oxygen	k€/yr.	-	50